

DL708E
Digital Scope

USER'S MANUAL

Foreword

Thank you for purchasing the YOKOGAWA DL708E Digital Scope. This User's Manual contains useful information about the instrument's functions and operating procedures as well as precautions that should be observed during use. To ensure proper use of the instrument, please read this manual thoroughly before operating it. Keep the manual in a safe place for quick reference whenever a question arises.

Three manuals are provided with the instrument, including this User's Manual.

| Manual Name | Manual No. | Description |
|--|---------------|---|
| DL708E User's Manual | IM 701820-01E | Describes all functions (except for the communications function) and their operation procedures for the instrument. |
| DL708E Communication Interface User's Manual | IM 701820-11E | Describes the communications function for the GP-IB/RS-232 interface. |
| DL708E Operation Guide | IM 701820-02E | Describes basic operations only. |

Notes

- The contents of this manual are subject to change without prior notice as a result of improvements in the instrument's performance and functions. Display contents illustrated in this manual may differ slightly from what actually appears on your screen.
- Every effort has been made in the preparation of this manual to ensure the accuracy of its contents. However, should you have any questions or find any errors, please contact your nearest YOKOGAWA representative listed on the back cover of this manual.
- Copying or reproduction of all or any part of the contents of this manual without YOKOGAWA's permission is strictly prohibited.

Trademarks

- MS-DOS is a registered trademark of Microsoft Corporation.
- HP-GL is a registered trademark of Hewlett-Packard Company.
- PostScript is a registered trademark of Adobe Systems Incorporated.
- ThinkJet is a registered trademark of Hewlett-Packard Company.
- All other company and product names used in this manual are trademarks or registered trademarks of their respective companies.

Revisions

1st Edition : June 1998
2nd Edition : April 1999

Checking the Contents of the Package

Unpack the box and check the contents before operating the instrument. If the wrong instrument or accessories have been delivered, if some accessories are missing or if they appear abnormal, contact the dealer from which you purchased them.

DL708E Main Body

Check that the model name and suffix code given on the name plate of the rear panel match those on your order. Whenever you contact the dealer from which you purchased the instrument, tell him your unit's serial No.

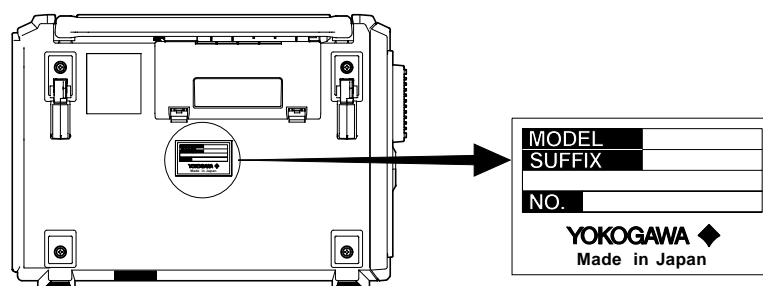

| Model | Suffix Code | Specifications |
|----------------------|-------------|--|
| 701820 | | The input module is not included with the instrument. Refer to page 3 for information on the input module. |
| Power supply voltage | -1 | 100-120 VAC |
| | -5 | 200-240 VAC |
| Power cord | -D | UL/CSA standard power cord (A1006WD) Maximum rated voltage: 125 V, maximum rated current: 7 A |
| | -F | VDE standard power cord (A1009WD) Maximum rated voltage: 250 V, maximum rated current: 10 A |
| | -Q | BS standard power cord (A1054WD) Maximum rated voltage: 250 V, maximum rated current: 10 A |
| | -R | SAA standard power cord (A1024WD) Maximum rated voltage: 240 V, maximum rated current: 10 A |
| Help language | -HJ | English and Japanese |
| | -HG | English and German |
| | -HF | English and French |
| | -HL | English and Italian |
| Options | /M1 | Memory extension to 1MW/CH ^{*1} |
| | /M2 | Memory extension to 2MW/CH ^{*1} |
| | /M3 | Memory extension to 4MW/CH ^{*1} |
| | /C7 | SCSI Interface ^{*2} |
| | /C8 | Internal hard disk + SCSI Interface ^{*2} |
| | /G2 | User define math function |
| | /F2 | External clock input ^{*3} |

*1 Choose one from /M1, /M2, and /M3.

*2 Select either /C7 or /C8.

*3 The external clock input function is not available on the High-speed Isolation Module (701855, 701850)/ High-speed Module (701856, 701851).

Example : Memory extension to 2 MW/CH + internal hard disk + user defined math function + external clock input → 701820-1-M/M2/C8/G2/F2

NO. (Instrument No.)

When contacting the dealer from which you purchased your instrument, please quote the instrument No.

Standard Accessories

The following standard accessories are supplied with the instrument. Make sure that all items are present and undamaged.

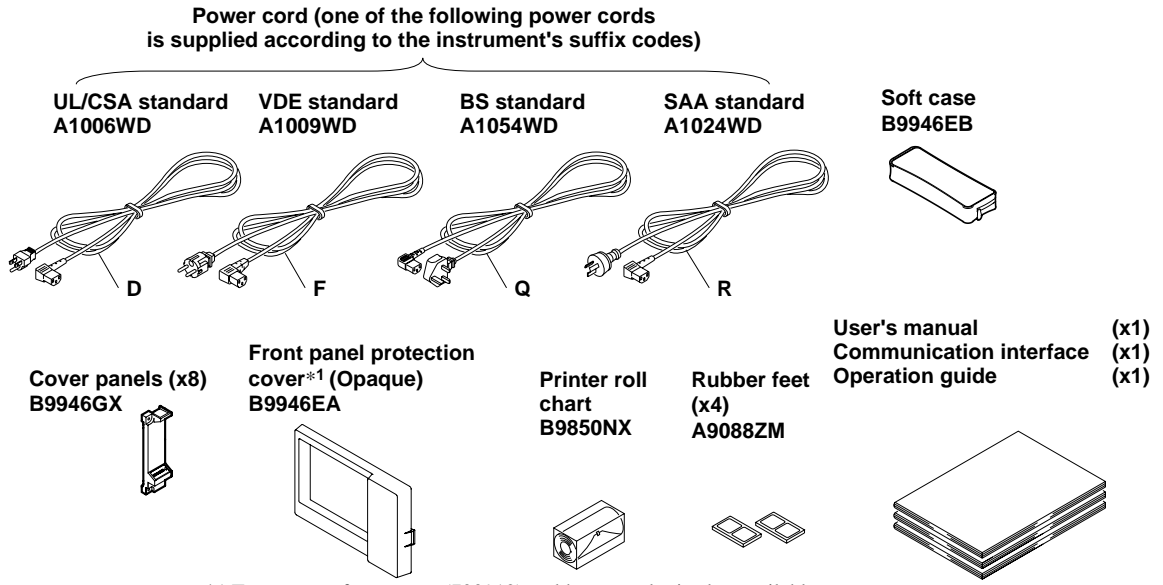

Input modules

Check that the MODEL indicated on the input module is what you ordered.

| Model | Name (Abbreviation) | |
|--------|---|-------------------|
| 701855 | High-Speed Isolation Module (HS_ISOL) | } Voltage Modules |
| 701856 | High-Speed Module (HS) | |
| 701852 | High-Resolution, High-Voltage, Isolation Module (HR_HV) | |
| 701853 | High-Resolution, Isolation Module (HR) | |
| 701860 | Temperature Module (TEMP) | |
| 701870 | Logic Input Module*1 (LOGIC) | |
| 701880 | Strain Module*2 (STRAIN) | |

*1 Use the Logic input module along with the dedicated probe (700986 or 700987) provided.

*2 Use the strain module along with the strain gauge bridge or the strain gauge transducer. Recommended bridge head: 700932 (120 W bridge resistance) or 70933 (350 W bridge resistance)



Note

- The High-Speed Isolation Module (701850) and High-Speed Module (701851) can also be used. See “Appendix 7” for details.
- The modules that can be used vary depending on the firmware version of the DL708E. See “Appendix 8” for details.

Optional Accessories

The following optional accessories are available. On receiving these optional accessories, make sure that all the items that you ordered have been supplied and that they are undamaged. If you have any questions regarding optional accessories, or if you wish to place an order, contact the dealer from whom you purchased the instrument.

Measurement lead for measuring voltages of 42 V or less

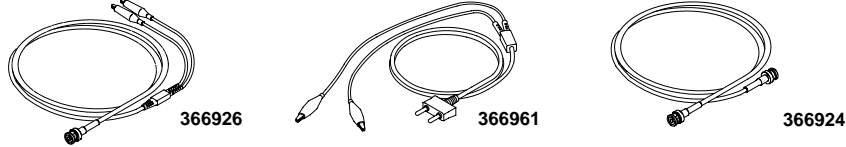

Measurement lead for measuring voltages of 42 V or more

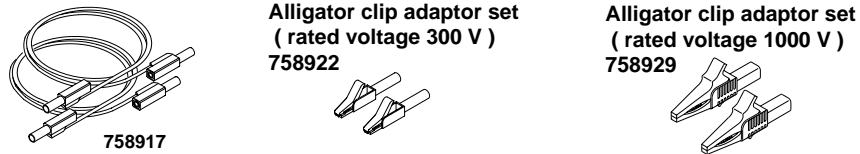

Probes

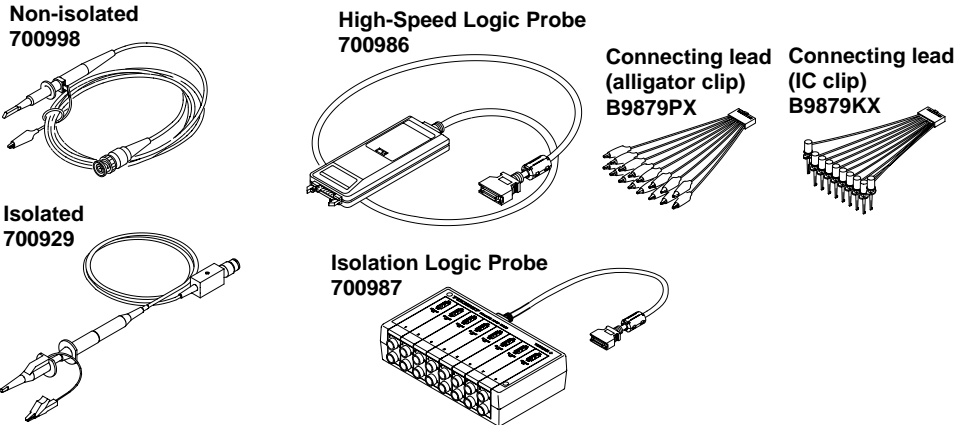

Bridge head/cable/connector for the strain module

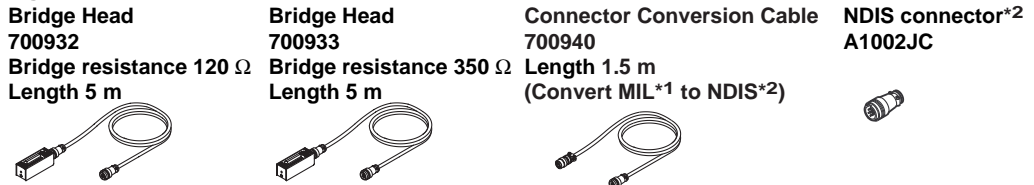

Other accessories

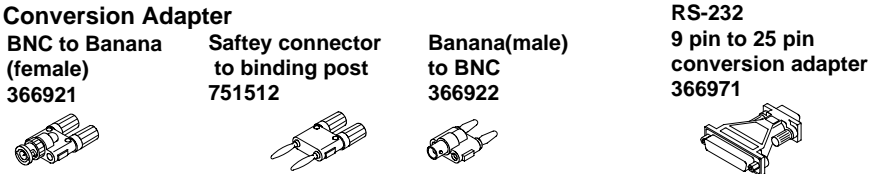

*1 MIL-C-26482 compatible connector
 *2 A connector recommended by JSNDI (The Japanese Society for Non-destructive Inspection)

Optional Spare Parts

The following optional spare parts are available. On receiving these optional spare parts, make sure that all the items that you ordered have been supplied and that they are undamaged. If you have any questions regarding optional spare parts, or if you wish to place an order, contact the dealer from whom you purchased the instrument.

| Part Name | Part No. | Minimum Q'ty | Remarks |
|------------|----------|--------------|---|
| Roll chart | B9850NX | 5 | Thermo-sensible paper, Total length: 30 m |

Note _____
 It is recommended that the packing box be kept in a safe place. The box can be used when you need to transport the instrument somewhere.

Safety Precautions

This instrument is an IEC safety class I instrument (provided with terminal for protective earth). The general safety precautions in next page must be observed during all phases of operation, service and repair of this instrument. If this instrument is used in a manner not specified in this manual, the protection provided by this instrument may be impaired. Also, YOKOGAWA Electric Corporation assumes no liability for the customer's failure to comply with these requirements.

The following symbols are used on this instrument.



To avoid injury, death of personnel or damage to the instrument, the operator must refer to an explanation in the User's Manual or Service Manual.



Functional earth terminal (This terminal should not be used as a "Protective earth terminal.")



Alternating current



ON(power)



OFF(power)

Make sure to comply with the following safety precautions. Not complying might result in injury, death of personnel or damage to the instrument.

WARNING

Power Supply

Ensure the source voltage matches the voltage of the power supply before turning ON the power.

Power Cord and Plug

To prevent an electric shock or fire, be sure to use the power cord supplied by YOKOGAWA. The main power plug must be plugged in an outlet with protective earth terminal. Do not invalidate protection by using an extension cord without protective earth.

Protective Earth

The protective earth terminal must be connected to earth to prevent an electric shock before turning ON the power.

Necessity of Protective Earth

Never cut off the internal or external protective earth wire or disconnect the wiring of protective earth terminal. Doing so poses a potential shock hazard.

Defect of Protective Earth and Fuse

Do not operate the instrument when protective earth or fuse might be defective.

Do not Operate in an Explosive Atmosphere

Do not operate the instrument in the presence of flammable liquids or vapors. Operation of any electrical instrument in such an environment constitutes a safety hazard.

Do not Remove any Covers

There are some areas with high voltages. Do not remove any cover if the power supply is connected. The cover should be removed by qualified personnel only.

External Connection

To ground securely, connect the protective earth before connecting to measurement or control unit.

Also, when touching the circuit, turn off the power to the circuit and check that there is no voltage being generated.

How to Use this Manual

Structure of the Manual

This User's Manual consists of 15 chapters, an Appendix and an Index as described below.

| Chapter | Title | Content |
|---------|---|---|
| 1 | Functions | Introduces the unit's features, functions, and operating principles. Please read this information to familiarize yourself with the unit's capabilities. This chapter does not present operational details. |
| 2 | Name and Use of Each Part | Briefly explains the significance and use of the unit's controls, connectors, and screen displays. Includes page references to help you find detailed information quickly. |
| 3 | Before Starting Observation and Measurement of Waveforms | Presents safety precautions, and explains how to install, connect up, and switch on the unit. Also explains how to connect the probes, install the input module, and how to set the date. |
| 4 | Common Operations | Explains basic operations, including acquisition start/stop, automatic setup, parameter reset, snapshots, trace clearing, and calibration. |
| 5 | Vertical and Horizontal Axes | Explains settings related to vertical (voltage) and horizontal (time) axes. Vertical-axis settings include channel on/off, input coupling, probe attenuation, and voltage sensitivity. |
| 6 | Triggering | Explains how to set up and use triggers to control timing of waveform acquisition. Includes description of trigger modes, trigger types, trigger source, and trigger level. |
| 7 | Acquisition and Display | Explains acquisition parameters (acquisition mode, record length, input filter, history), realtime print to the built-in printer, and realtime recording to the internal hard disk (optional), etc. |
| 8 | Display | Explains display format, interpolation, zoom, X-Y display, graticule, use of overlapping (accumulated) waveform display, and other display-related parameters. |
| 9 | Waveform Analysis | Explains cursor-based measurements, automatic measurements, statistical processing, mathematical operations, and GO/NO-GO determinations. |
| 10 | Output of Screen Data | Explains how to print or store screen data to Built-in printer, to floppy, to internal HDD (Optional), to an external SCSI device, to a printer with a centronics interface, or to a plotter or other device connected through the GP-IB interface. |
| 11 | Saving/Loading the Data/Connecting to the PC | Explains how to save and reload waveform data and settings to floppy disk, internal HDD (Optional), or external SCSI device. Also explains related disk operations, including disk formatting, file copying, and file deletion. |
| 12 | Rear-Panel Input/Output | Explains external-trigger input, external-clock input, trigger output, and video output. |
| 13 | Other Operations | Explains how to set the display colors, display language, click sound, and screen saver. |
| 14 | Troubleshooting, Maintenance, and Inspection | Gives troubleshooting advice; explains screen messages and self-test operation. |
| 15 | Specifications | Specifications on the main instrument and the input module are summarized in tables. |
| | Appendix | Explains the relationships between time axis, sampling rate, and record length, the format for ASCII file headers, initial values, details on the user-defined computation and compatibility between modules and DL708E. |
| | Index | Index of contents. |

Conventions Used in this Manual

Unit

k Denotes “1000”. Example: 100 kS/s

K Denotes “1024”.

Example: 640 KB (storage capacity of a floppy disk)

Used Characters

Alphanumerics enclosed in double quotation marks usually refer to characters and set values that appear on the screen and panel.

The SHIFT + xxx key refers to first pressing the SHIFT key (the indicator above the SHIFT key lights), and then pressing the xxx key to obtain another, specified, function.

Note

The following symbol marks are used to attract the operator’s attention.



Affixed to the instrument, indicating that for safety, the operator should refer to the User’s Manual.



Describes precautions that should be observed to prevent the danger of injury or death to the user.



Describes precautions that should be observed to prevent damage to the instrument.

Note

Provides information that is important for proper operation of the instrument.

Symbol Marks Used for Descriptions of Operations

The following symbol marks are used in Chapters 3 to 14 to distinguish certain features in descriptions.

Function

Describes settings and restrictions relating to the operation. A detailed description of the function is not provided. For a detailed description of the function, refer to Chapter 1.

Operating Procedure

Carry out steps in the order shown. The operating procedures are given with the assumption that you are not familiar with the operation. Thus, it may not be necessary to carry out all the steps when changing settings.

Contents

| | |
|---|------|
| Foreword | 1 |
| Checking the Contents of the Package | 2 |
| Safety Precautions | 5 |
| How to Use this Manual | 7 |
| | |
| Chapter 1 Functions | |
| 1.1 Block Diagram | 1-1 |
| 1.2 Setting the Vertical and Horizontal Axes | 1-2 |
| 1.3 Setting a Trigger | 1-7 |
| 1.4 Setting the Acquisition and Display Conditions | 1-12 |
| 1.5 Analyzing the Waveform | 1-19 |
| 1.6 Other Useful Functions | 1-23 |
| | |
| Chapter 2 Name and Use of Each Part | |
| 2.1 Front Panel/Rear Panel | 2-1 |
| 2.2 Operation Keys/Jog Shuttle/Knobs | 2-2 |
| 2.3 Screens | 2-5 |
| | |
| Chapter 3 Before Starting Observation and Measurement of Waveforms | |
| 3.1 Precautions During Use | 3-1 |
| 3.2 Installing | 3-2 |
| △ 3.3 Connecting the Power Cord | 3-4 |
| 3.4 Setting the Date and Time | 3-6 |
| △ 3.5 Installing the Input Module | 3-7 |
| △ 3.6 Connecting a Probe (For High-Speed Isolation/High-Speed Modules) | 3-9 |
| △ 3.7 Connecting a Input Cable (For High-Resolution, High Voltage, Isolation/High-Resolution, Isolation Modules) | 3-11 |
| △ 3.8 Connecting a Thermocouple | 3-12 |
| △ 3.9 Connecting a Logic Probe | 3-13 |
| △ 3.10 Compensating the Probe (Phase Correction) | 3-15 |
| △ 3.11 Connecting the Bridge Head (For Strain Module) | 3-16 |
| | |
| Chapter 4 Common Operations | |
| 4.1 Entering Values and Character Strings | 4-1 |
| 4.2 Initializing Settings | 4-3 |
| 4.3 The Auto Set-up Function | 4-4 |
| 4.4 Starting and Stopping Acquisition | 4-6 |
| 4.5 The Snapshot and Clear Trace Functions | 4-8 |
| 4.6 Calibration | 4-9 |
| 4.7 Using the Help Function | 4-10 |
| 4.8 Selecting the Time Base | 4-11 |

Chapter 5 Vertical and Horizontal Axes

| | | | |
|---|------|--|------|
| | 5.1 | Turning Channels ON/OFF | 5-1 |
| | 5.2 | Setting T/div | 5-2 |
| | 5.3 | Setting V/div | 5-4 |
| | 5.4 | Setting the Vertical Position of a Waveform | 5-5 |
| △ | 5.5 | Selecting Input Coupling | 5-6 |
| | 5.6 | Selecting Probe Attenuation | 5-7 |
| | 5.7 | Setting the Bandwidth | 5-8 |
| | 5.8 | Zooming in Vertical Direction | 5-10 |
| | 5.9 | Setting the Offset Voltage | 5-11 |
| | 5.10 | Using the Linear Scaling Function | 5-12 |
| | 5.11 | Inverting a Waveform | 5-14 |
| | 5.12 | Setting the ON/OFF of Channels and the V/div with the All Channel Setting Menu | 5-15 |
| | 5.13 | Setting the Temperature Measurement | 5-16 |
| | 5.14 | Setting the Logic Probe | 5-18 |
| | 5.15 | Setting the Strain Measurement | 5-19 |
| | 5.16 | Using the Linear Scaling Function for the Strain | 5-22 |

Chapter 6 Triggering

| | | | |
|--|------|--|------|
| | 6.1 | Setting the Trigger Mode | 6-1 |
| | 6.2 | Selecting a Channel for Setting Trigger Hysteresis and Trigger Level | 6-2 |
| | 6.3 | Setting Trigger Hysteresis for Channels 1 to 8 | 6-3 |
| | 6.4 | Setting the Trigger Level | 6-4 |
| | 6.5 | Setting the Hold off Time | 6-5 |
| | 6.6 | Setting the Trigger Position | 6-6 |
| | 6.7 | Setting the Trigger Delay | 6-8 |
| | 6.8 | Setting the Edge Trigger (SIMPLE) | 6-9 |
| | 6.9 | Setting the A/B (n) Trigger (ENHANCED) | 6-10 |
| | 6.10 | Setting the A Delay B Trigger (ENHANCED) | 6-12 |
| | 6.11 | Setting the Edge on A Trigger (ENHANCED) | 6-14 |
| | 6.12 | Setting the OR Trigger (ENHANCED) | 6-16 |
| | 6.13 | Setting the B>Time, B<Time or B Time Out Trigger (ENHANCED) | 6-17 |
| | 6.14 | Setting the Window Trigger (ENHANCED) | 6-19 |
| | 6.15 | Setting the Timer Trigger | 6-21 |

Chapter 7 Acquisition and Display

| | | | |
|--|-----|--|------|
| | 7.1 | Setting the Record Length | 7-1 |
| | 7.2 | Acquisition Mode | 7-2 |
| | 7.3 | Sequential Store Mode | 7-4 |
| | 7.4 | Box Average Mode | 7-5 |
| | 7.5 | Using the History Memory | 7-6 |
| | 7.6 | Realtime Print to the Built-in Printer | 7-9 |
| | 7.7 | Realtime Record to the Internal Hard Disk (Optional) | 7-11 |

Chapter 8 Display

| | | | |
|--|-----|--|-----|
| | 8.1 | Changing the Display Format | 8-1 |
| | 8.2 | Setting the Interpolation Method | 8-2 |
| | 8.3 | Changing the Graticule | 8-4 |

| | | | |
|-----|--|------|---|
| 8.4 | Accumulated Waveform Display | 8-5 | 1 |
| 8.5 | Turning the Extra Window ON/OFF | 8-7 | 2 |
| 8.6 | Turning Display of the Scaling Value and Trigger Mark ON/OFF | 8-8 | 3 |
| 8.7 | Setting the Waveform Labels | 8-9 | 4 |
| 8.8 | X-Y Waveform Display | 8-10 | 5 |
| 8.9 | Zooming the Waveform | 8-12 | 6 |

Chapter 9 Waveform Analysis

| | | | |
|------|--|------|-----|
| 9.1 | Measuring Waveforms using Cursors | 9-1 | 7 |
| 9.2 | Automatic Measurement of Waveform Parameters | 9-4 | 8 |
| 9.3 | Setting Computing Range and Display Units, and Recomputing | 9-9 | 9 |
| 9.4 | Waveform Addition, Subtraction and Multiplication | 9-10 | 10 |
| 9.5 | Binary Computation | 9-11 | 11 |
| 9.6 | Phase Shifted Addition, Subtraction and Multiplication | 9-13 | 12 |
| 9.7 | Simultaneous Binary Computation and D/A Conversion of All Channels | 9-15 | 13 |
| 9.8 | Displaying Power Spectrums | 9-17 | 14 |
| 9.9 | Manual Scaling | 9-18 | 15 |
| 9.10 | Executing User Defined Computation (Optional) | 9-19 | App |

Chapter 10 Output of Screen Data

| | | | |
|------|--|-------|---|
| 10.1 | Loading Paper Roll in Printer | 10-1 | 1 |
| 10.2 | Feeding the Chart | 10-3 | 2 |
| 10.3 | Outputting to Printer | 10-4 | 3 |
| △ | 10.4 Outputting to a Printer with a Centronics Interface | 10-6 | 4 |
| 10.5 | GP-IB/RS-232 Interface : Data Output and Format Selection | 10-8 | 5 |
| 10.6 | Outputting to Floppy Disk, Internal Hard Disk (Optional) or External SCSI Device | 10-12 | 6 |

Chapter 11 Saving/Loading the Data/Connecting to the PC

| | | | |
|-------|---|-------|----|
| 11.1 | Floppy Disks | 11-1 | 7 |
| △ | 11.2 Internal Hard Disk (Optional) | 11-2 | 8 |
| 11.3 | Connecting a SCSI Device | 11-3 | 9 |
| 11.4 | Formatting Disks | 11-4 | 10 |
| 11.5 | Selecting the Medium and Directory | 11-7 | 11 |
| 11.6 | Saving/Loading Waveform Data | 11-8 | 12 |
| 11.7 | Saving/Loading Set-up Data | 11-12 | 13 |
| 11.8 | Saving Waveform Data in ASCII, Binary or AG Series Format | 11-14 | 14 |
| 11.9 | Deleting Files | 11-16 | 15 |
| 11.10 | Copying Files | 11-17 | 16 |
| 11.11 | Saving Automatic Measurement Results | 11-18 | 17 |
| 11.12 | Changing the SCSI IDs | 11-19 | 18 |
| △ | 11.13 Connecting to a PC | 11-20 | 19 |

Chapter 12 External Trigger Input/Output, Video Signal Output

| | | | |
|---|---|------|----|
| △ | 12.1 External Trigger Input (TRIG IN) | 12-1 | 20 |
| △ | 12.2 Trigger Output (TRIG OUT) | 12-2 | 21 |
| △ | 12.3 Video Signal Output (VIDEO OUT) | 12-3 | 22 |

| |
|-------|
| 1 |
| 2 |
| 3 |
| 4 |
| 5 |
| 6 |
| 7 |
| 8 |
| 9 |
| 10 |
| 11 |
| 12 |
| 13 |
| 14 |
| 15 |
| App |
| Index |

Chapter 13 Other Operations

13.1 Setting the Screen Color 13-1
 13.2 Setting the Message Language, Click Sound and Brightness of the LCD 13-3
 13.3 Setting the Screen Saver Function 13-4
 13.4 Setting the Action on Trigger 13-5

Chapter 14 Troubleshooting, Maintenance and Inspection

14.1 Breakdown Troubleshooting 14-1
 14.2 Error Messages and Corrective Actions 14-2
 14.3 Self-Diagnostic Test (Self Test) 14-5
 14.4 Checking the System Condition 14-7
 14.5 Warranties on Parts 14-8

Chapter 15 Specifications

15.1 Input Section 15-1
 15.2 Trigger Section 15-1
 15.3 Time Axis 15-2
 15.4 Display 15-2
 15.5 Functions 15-2
 15.6 External Trigger Input/Output, Video Signal Output 15-4
 15.7 GP-IB Interface 15-4
 15.8 RS-232 Interface 15-4
 15.9 Centronics Interface 15-4
 15.10 SCSI Interface 15-5
 15.11 Built-in Printer 15-5
 15.12 Built-in Floppy Disk Drive 15-5
 15.13 Internal Hard Disk (Optional) 15-5
 15.14 General 15-6
 15.15 External Dimensions 15-8
 15.16 High-speed Isolation Module (701855) 15-9
 15.17 High-speed Module (701856) 15-10
 15.18 High-Resolution, High-Voltage, Isolation Module (701852) 15-11
 15.19 High-Resolution, Isolation Module (701853) 15-12
 15.20 Temperature Module (701860) 15-13
 15.21 Logic Input Module (701870) 15-14
 15.22 Strain Module (701880) 15-15

Appendix

Appendix 1 Relationship between the Time Axis Setting, Sample Rate and Record Length App-1
 Appendix 2 Relationship between the Record Length and Acquisition Mode App-3
 Appendix 3 How to Calculate the Area of a Waveform App-4
 Appendix 4 ASCII Header File Format App-5
 Appendix 5 List of Defaults App-8
 Appendix 6 About User Defined Computations App-9
 Appendix 7 For Input Module 701850 and 701851 App-14
 Appendix 8 Compatibility between Input Modules and DL708E App-18



Index

1.1 Block Diagram

System Configuration

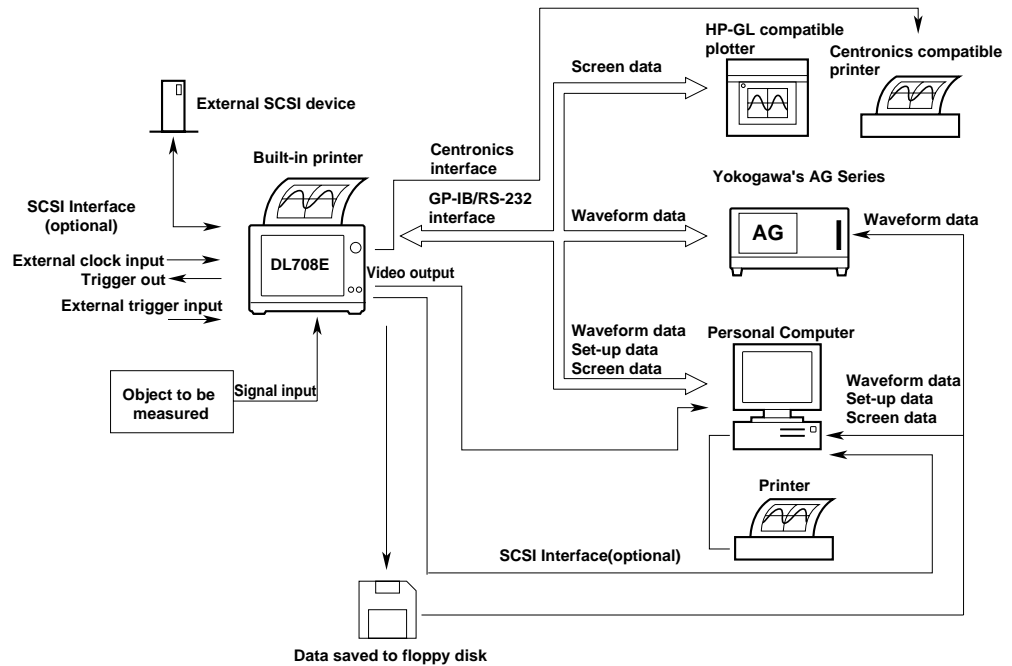

Block Diagram

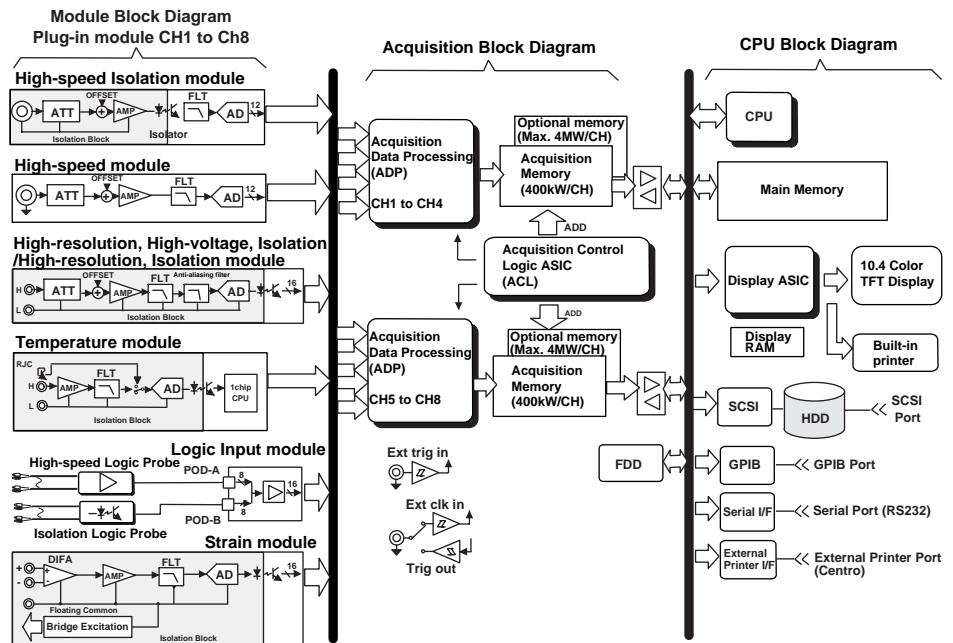

Signal flow

The signal flow at the input end varies depending on the module. Here, the high-Speed Isolation Module is taken as an example (refer to the block diagram for the signal flow of each module).

First, the signal input from the input terminal is processed at the input section. In the input module (High-Speed Isolation), the input signal is attenuated/amplified by the attenuator (ATT), the adder, and the preamplifier. Then, the signal is isolated through the analog isolator. Bandwidth limiting is done immediately before the A/D converter.

In the A/D converter, the input signal is sampled at a sampling rate of 10 MS/s (10 million times in 1 second) and converted to digital data.

The digital signals of the eight channels in the CPU board go through the primary and secondary processing circuits and are finally displayed on the TFT display. In the primary processing circuit, the ADP(acquisition data processor)/ACL(acquisition control processor) indicated in the block diagram writes the signal to the memory. In the secondary processing circuit, the high-speed microprocessor converts the data for data compression and image processing.

1.2 Setting the Vertical and Horizontal Axes

Time Axis ≡ Page 5-2. ≡

Setting the time axis

When using the internal clock, set the time axis scale as a time duration per division of the grid. The setting range is 500 ns/div to 100 ks/div*. The time range in which waveform is displayed is “time axis setting x 10”, as the display range along the horizontal axis is 10 divisions.

* 100 ks indicates 100000 seconds (27 hours 46 minutes 40 seconds).

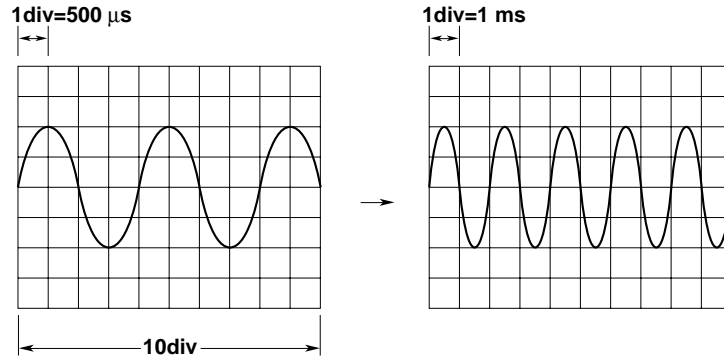

Note

Display of time axis direction

The number of display points in the time axis direction on a 10-div screen is 1002 points (i.e. 2 points per raster). Processing therefore varies according to record length, as described immediately below. (for more details on the relation between time axis, record length and displayed record length, refer to Appendix 1).

- If record length exceeds number of screen display points (see page 8-2)
If the display style is set to “P-P”, the oscilloscope uses P-P compression to generate a 1002-point display (regardless of interpolation setting).
If interpolation is “OFF” and the display style is set to “Decim,” the instrument thins the data to generate a 1002-point display. If the display style is set to “All,” then all data points are displayed.
- If record length is less than number of screen display points
The instrument interpolates the data to generate the display. (See page 1-16.)

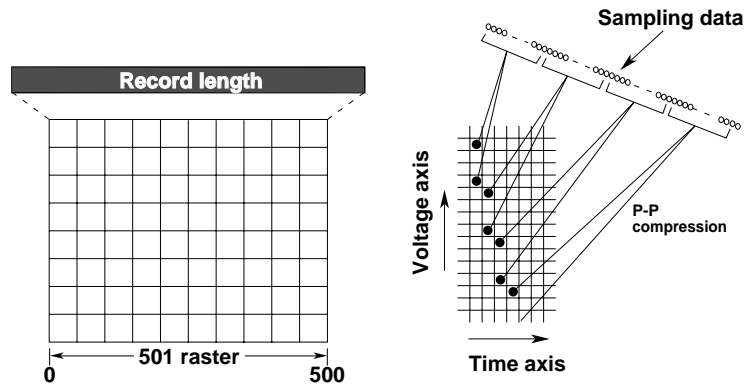

Relationship between the time axis setting, sample rate and record length

Changing the time axis causes corresponding changes in the sampling rate and the acquisition record length. For more detailed information, refer to Appendix 1.

Sample rate

Changing the time axis causes a corresponding change in the sampling rate. Maximum sampling rate is 10MS. The waveform can only be displayed correctly at frequencies up to half the sample rate, due to Nyquist's theorem*. Sample rate is expressed in S/s (number of samples per second).

* If the sample rate is higher than the frequency of the input signal, high frequency components will be lost. In this case, a phenomenon in which high frequency components change to lower frequency components occurs, due to Nyquist's theorem. This phenomenon is called aliasing. Aliasing can be avoided by setting the acquisition mode to envelope mode and acquiring the waveform.

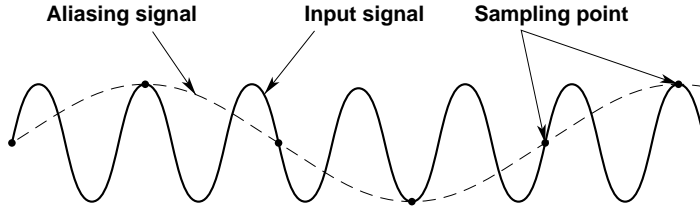

Time axis setting and roll mode display

If the trigger mode is auto or auto level; T/div is between 100 ms/div and 100 ks/div; and the sample rate is under 100 kS/s, instead of the waveform display being updated (update mode) by the trigger, the waveform is displayed in roll mode. In roll mode, the waveform display flows right to left on the screen erasing the oldest data as new data is acquired. A waveform can be observed in the same way as it is recorded on a pen recorder. This mode is useful when you are observing a signal which repeats or which fluctuates slowly. This mode is also useful when you want to detect glitches (fast spikes on a waveform) which occur intermittently.

Limitation during roll mode display

- When the trigger mode is set to normal, the waveform is not displayed in roll mode except when "Log Start" or "Single Start"* is selected from the ACQ menu.
 - * If the firmware version of the DL708E is 4.00 or later, waveforms are displayed in roll mode when the "Single Start" soft key is pressed.
- The operation when "Single Start"/"Log Start" is selected from the ACQ menu is as follows.
 - By pressing the "Single Start" soft key, the trigger mode is set to normal mode. After acquiring the specified record length of data following a trigger activation, the displayed waveform stops.
 - By pressing the "Log Start" soft key, the trigger mode is disabled. After acquiring the specified record length of data, the displayed waveform stops.
- The T/div setting during the roll mode display may sometimes be inadequate for observing the changes in the waveform on the main area (see page 1-17). In this case, you can use the zoom area to check the changes in the waveform.

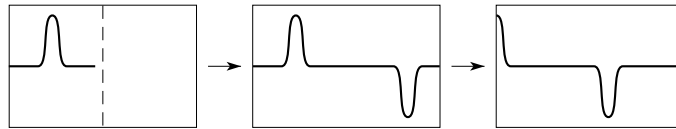

Vertical Sensitivity (For Voltage Modules) ≡ Page 5-4. ≡

The V/div (vertical sensitivity) setting is used to adjust the amplitude of the displayed waveform so that the waveform can be observed easily.

The V/div setting is made by setting the voltage value per division on the screen grid. The vertical sensitivity is changed by switching the input section with a different attenuator having a different damping factor. The setting changes in steps (1 V/div → 2 V/div → 5 V/div...).

When V/div is switched from 1 V/div to 500 mV/div

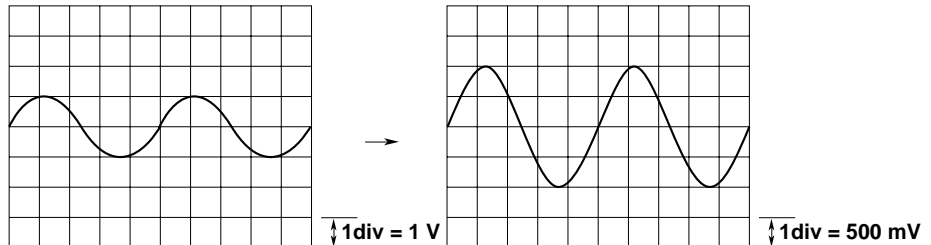

Note

Vertical sensitivity and measurement resolution

To get precise readings, it is recommended that you set the vertical sensitivity so that the waveform's maximum and minimum amplitudes are close to the top and bottom of the screen.

This instrument uses a 12 bit (on High-Speed Isolation/High-Speed Modules) or a 16 bit (on High-Resolution, High-Voltage, Isolation/High-Resolution, Isolation Modules) A/D converters and samples the input signal with a resolution of 4000 levels (on High-Speed Isolation/High-Speed Modules) or 64000 levels (on High-Resolution, High-Voltage, Isolation/High-Resolution, Isolation Modules). Also, the waveform is displayed in 500 levels (on High-Speed Isolation/High-Speed Modules) or 8000 levels (on High-Resolution, High-Voltage, Isolation/High-Resolution, Isolation Modules) per 1 div on the grid.

Vertical Position (for Voltage/Logic Input Modules Only) ≡ Page 5-5. ≡

Since a total of eight input waveforms can be displayed, they may overlap each other, making observation difficult. In this case, the waveforms can be moved in the vertical direction so that can be observed more easily.

The vertical position can be set to any value in the range between ± 4 div.

Changing the V/div setting, the vertical axis setting is rescaled with respect to the vertical position.

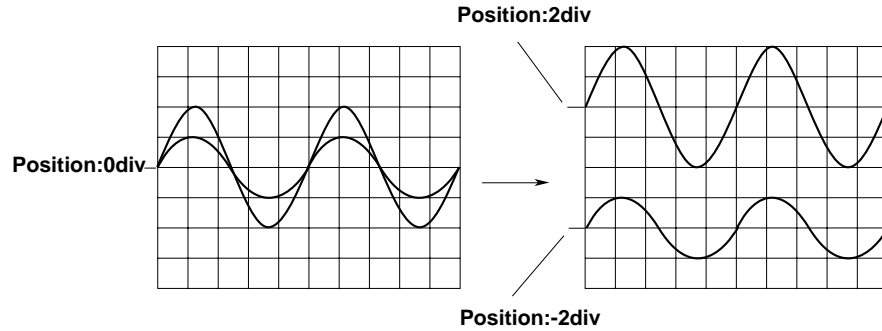

Input coupling (For Voltage Modules) ≡ Page 5-6. ≡

When you only want to observe the amplitude of an alternating current signal, eliminating the direct current components from the input signal makes observation easier. You may also want to check the ground level or observe the input signal waveform with the offset voltage removed. In these cases, you can change the input coupling setting. This will switch the coupling method, which determines how the input signal is input to the vertical control circuit (voltage axis). The input coupling method can be chosen from the following.

AC

The input signal is sent through a capacitor to the attenuator in the vertical control circuit. This method can be used when you just want to observe the amplitude of the alternating current signal, eliminating the DC components from the input signal.

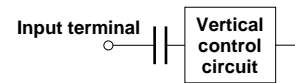

DC

The input signal is sent directly to the attenuator in the vertical control circuit.

This method can be used when you want to observe both the DC and AC components of the vertical input signal.

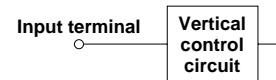

GND

The ground signal, not the input signal, is connected to the attenuator in the vertical control circuit. This method enables observation of the ground level on the screen.

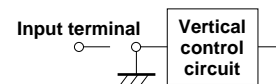

Probe Attenuation (For Voltage Modules) ≡ Page 5-7. ≡

When making voltage measurements, using a probe to connect the circuit being measured and the measurement input terminals has the following advantages:

- the voltage and current of the circuit to be measured are not disturbed;
- a signal can be input without distortion;
- the measurement voltage range of the oscilloscope can be widened.

When a probe is used, the probe attenuation must match the instrument's attenuation setting so that the input voltage can be measured directly.

Set to 10:1 or 1:1 when using the accessory voltage probe (700998).

Set to 10:1 when using the accessory isolating probe (700929).

In addition to 10:1, attenuations of 1:1, 100:1 and 1000:1 are provided.

When using a probe or cable besides the ones provided as accessories, set the appropriate attenuation ratio meeting its specification.

Bandwidth Limit (For Voltage, Temperature, and Strain Modules) ≡ Page 5-8. ≡

The bandwidth limit of each module can be set individually. By setting a bandwidth limit, the noise component of the input signal can be deleted during waveform observation.

Zooming in the Vertical Direction ≡ Page 5-10. ≡

Every displayed waveform can be enlarged/reduced by a factor between “x0.1 to x100” in the vertical direction. Zooming is done with the center at the vertical position.

When “V Zoom” is switched from “x1” to “x2”

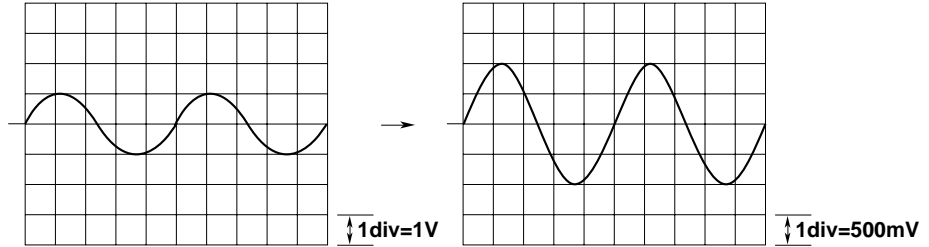

Offset Voltage (For Voltage Modules) ≡ Page 5-11. ≡

Since the signal you wish to see can be moved to the vertical position by adding an offset voltage, the observation can be made with a higher voltage sensitivity.

Note that the offset value has no affect on cursor measurements, automatic measurements, and mathematical calculations.

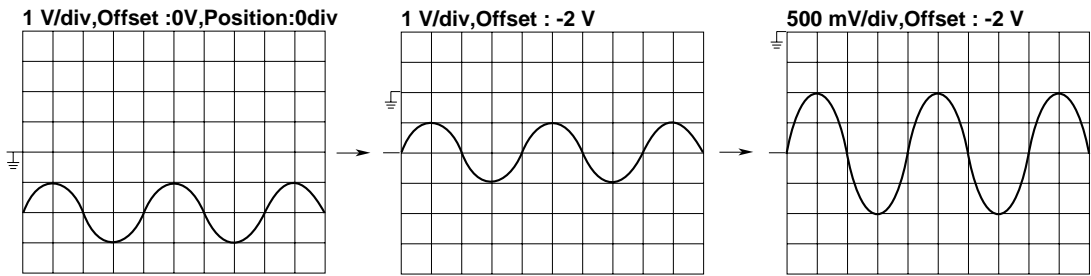

Inverted Waveform Display ≡ Page 5-14. ≡

The voltage axis is inverted about the vertical position as shown below, and the waveform is displayed.

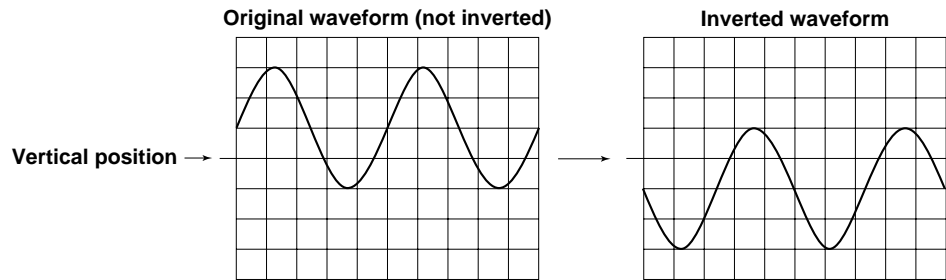

Temperature Measurement ≡ Page 5-16. ≡

Types of thermocouples

The types of thermocouples available are as follows.

K, E, J, T, L, U, N, R, S, B, W and KPvsAu7Fe

Temperature unit

Can specify °C, °F or K.

Reference Junction Compensation (RJC)

- The voltage generated by a thermocouple depends on the temperature of the spot of measurement and the reference junction temperature. In this case, the function to compensate the temperature on the measurement instrument side to the cold junction is referred to as reference junction compensation.
- This instrument can turn ON/OFF the internal RJC circuit.
 - ON : Use this setting to enable the reference junction compensation by the internal RJC circuit.
 - OFF : Use this setting when checking the temperature measurement value, or when using an external reference junction (0 °C).

Strain measurement ≡ Page 5-19. ≡

You can measure the strain by connecting a strain gauge bridge (bridge head) or a strain gauge transducer to the strain module.

1.3 Setting a Trigger

Trigger Type ≡ Chapter 6. ≡

There are two principal trigger types which you can use with the instrument.
 Simple trigger
 Enhanced trigger

Simple trigger → Pages 6-1 to 6-9.

Triggers on the edge of a single signal (edge trigger).

Enhanced trigger → Pages 6-1 to 6-8 and 6-10 to 6-20.

This is a complex trigger. The following eight types of enhanced trigger are available.

- A→B(n) trigger
- A Delay B trigger
- Edge on A trigger
- OR Trigger
- B>Time trigger
- B<Time trigger
- B Time Out trigger
- Window trigger

Edge trigger → Page 6-9.

The edge trigger is the simplest type of trigger and uses a single trigger source to activate a trigger. A trigger is activated when the trigger source exceeds (rises above) or drops (falls) below the preset trigger level*.

In addition to input signals (CH1 to CH8), the external trigger input signal and the commercial power supply signal can be used as a trigger source.

* "A trigger is activated" refers to the condition in which trigger conditions are satisfied and a waveform is displayed.

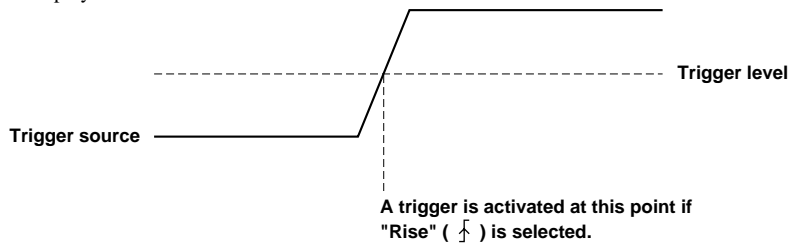

A → B(n) trigger (Enhanced Trigger) → Page 6-10.

This function activates a trigger the nth time condition B becomes true after condition A has become true.

When pattern A : CH1 = L, CH2 = L, Enter, When patternB : CH1 = H, CH2 = H, Enter, n = 3

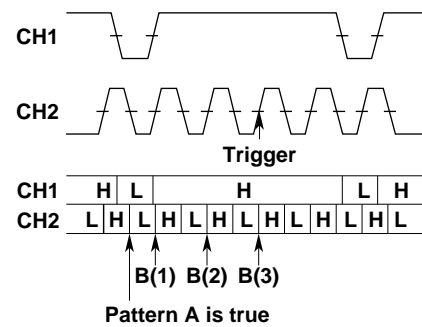

A Delay B trigger (Enhanced Trigger) → Page 6-12.

A trigger is activated the 1st time condition B becomes true after condition A has become true and a preset time has elapsed.

When pattern A : CH1 = L, CH2 = L, Enter, When pattern B : CH1 = H, CH2 =H, Enter, Delay = 2μs

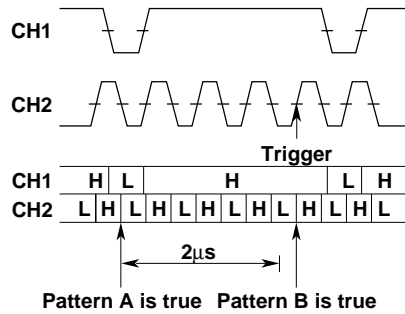

Edge on A (Enhanced Trigger) → Page 6-14.

A trigger is activated when an OR trigger occurs while condition A is true.

When pattern A : CH1 = L, CH2 = L, CH3 = H, CH4 = L, True, Edge OR : CH6↑

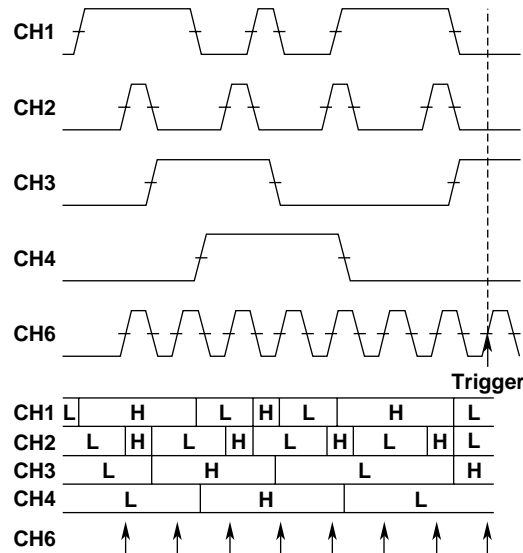

OR trigger (Enhanced Trigger) → Page 6-16.

A trigger is activated when either of the selected edge triggers occurs. A trigger can be activated by either the rising edge of CH1 or CH2.

When CH1 = ↑, CH2 = ↑

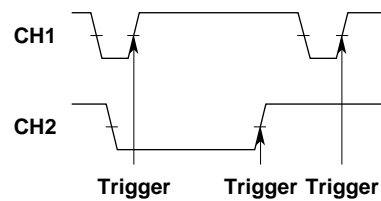

B>Time, B<Time, B Time out (Enhanced Trigger) → Page 6-17.

A trigger is activated on the falling or rising edge of the pulse when the pulse width exceeds (or drops below) the preset time. In the case of a “Time out” trigger, a trigger is activated when the preset time elapses. If multiple signals are used, a trigger is activated by the AND of the multiple signals.

When B > Time, CH1 = H, Time = 4μs

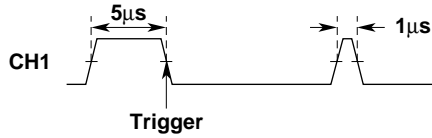

When B < Time, CH1 = H, Time = 4μs

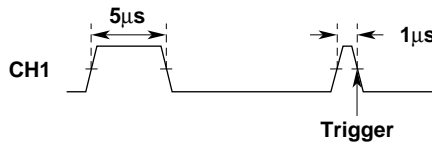

When B Time Out, CH1 = H, Time = 4μs

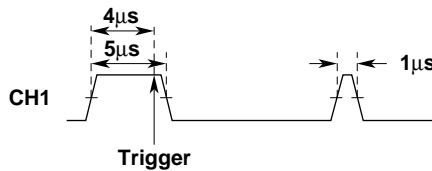

Window Trigger (Enhanced Trigger) → page 6-19.

A certain voltage range (window) is set and a trigger is activated when the trigger source level enters this voltage range ($\overline{\uparrow}$)* or exits from this voltage range ($\overline{\downarrow}$)*.

* This is the display when the firmware version of the DL708E is 4.00 or later. For DL708Es of earlier versions, “IN” and “OUT” are displayed as “ $\overline{\uparrow}$ ” and “ $\overline{\downarrow}$,” respectively.

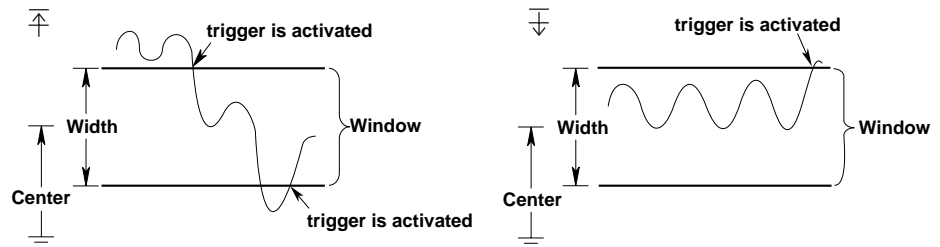

Timer Trigger (Simple Trigger)* → page 6-21.

The trigger is activated at the specified interval from the specified time.

* This function is available on DL708Es with firmware versions 4.00 or later.

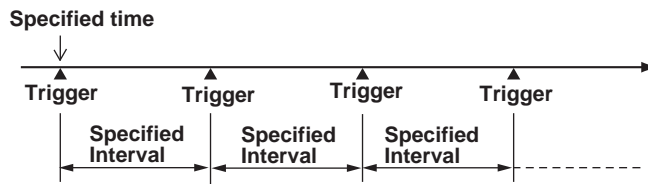

Trigger Mode ≡ Page 6-1. ≡

Conditions for updating displayed waveforms are set. The following two types of trigger mode are available.

Auto-mode

Displayed waveforms are updated each time a trigger is activated within a specified time (approximately 50 ms, referred to as the time-out period) and are updated automatically after each time-out period.

Auto level mode

If a trigger is activated before the timeout period, it displays the waveform in the same way as in the auto mode. If the trigger is not activated within the timeout period, then the center value of the amplitude of the trigger source is detected, and the trigger level is changed to that value. The trigger is activated using the new value and the displayed waveform is updated.

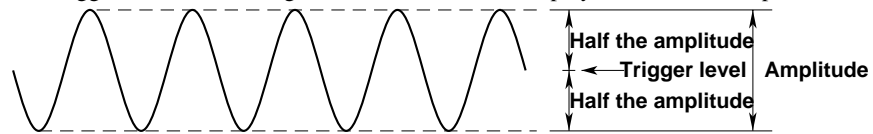

Normal mode

Displayed waveforms are updated only when a trigger is activated. Displayed waveforms will not be updated if no trigger is activated.

Trigger Hysteresis (For Voltage and Temperature Modules) ≡ Page 6-3. ≡

Allow the trigger level to have a width, so that the trigger does not get activated due to small fluctuations in the signal. Select the trigger hysteresis from the following three choices.

- $\overline{\Delta}$: Hysteresis of about ± 0.1 div centered on the trigger level.
- $\overline{\Delta}$: Hysteresis of about ± 0.5 div centered on the trigger level.
- $\overline{\Delta}$: Hysteresis of about ± 1 div centered on the trigger level.

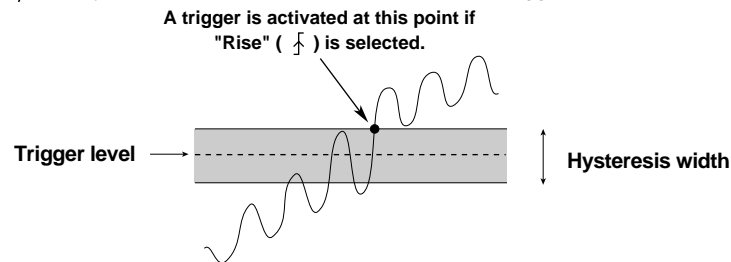

Trigger Source and Trigger Level ≡ Page 6-2 and 6-4. ≡

- Trigger source** : Selects the signal for the selected trigger type.
- Trigger level** : Sets the voltage level used to judge trigger conditions such as trigger slope (rise/fall of a signal).

Trigger Hold-off ≡ Page 6-5. ≡

The trigger hold-off function temporarily stops detection of the next trigger once a trigger has been activated. For example, when observing a pulse train signal, such as a PCM code, display of the waveform can be synchronized with repetitive cycles; or when using the history memory function, you may want to change the repetitive period, as shown below.

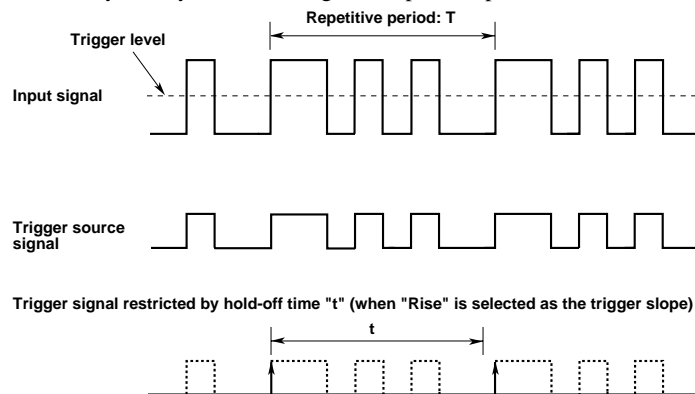
**Trigger Position/Trigger Delay ≡ Page 6-6 to 6-8. ≡**

Specify which part of the acquired waveform in the acquisition memory to display on the screen by setting the trigger position. Trigger position is equal to the trigger point when the trigger delay is set to 0 s.

By using the trigger delay function, the waveform whose acquisition starting point is delayed from the trigger point by the trigger delay time can be displayed.

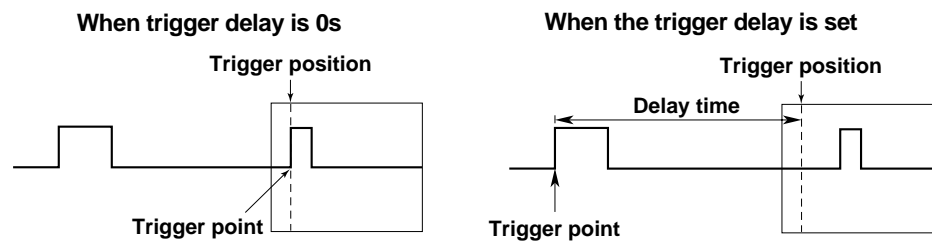

Changing the T/div setting, the time axis setting is rescaled with respect to the trigger position. The time measurement of cursor measurements and automatic measurement of waveform parameters is based on the trigger position (0 s).

1.4 Setting the Acquisition and Display Conditions

Record Length ≡ Page 7-1. ≡

Normally, the term record length refers to the number of data points acquired in the acquisition memory per channel. Display record length refers to the number of these data points that are actually displayed on the screen. The sample rate and record length vary according to the time axis setting (refer to page 1-2). This instrument allows the record length to be selected from the following choices: 1 kW, 10 kW, 40 kW, 100 kW, 200 kW, 400 kW, 1 MW, 2 MW, 4 MW, 8 MW and 16 MW (The maximum record length that can be selected depends on the options). In most cases the displayed record length is identical to the (acquisition) record length. For certain time-axis settings, however, the lengths become different. For details, refer to Appendix 1.

To observe all of the data when the display record length is shorter than the set record length, move the horizontal position of the horizontal zoom function. For details, refer to Section 8.9 "Zooming the Waveform."

Acquisition Modes ≡ page 7-2. ≡

When storing sampled data in the acquisition memory, it is possible to perform processing on specified data and display the resultant waveform. The following data processing methods are available.

Normal mode

In this mode, sampled data are stored in the acquisition memory without processing.

Averaging mode

Averaging is a process in which waveforms are acquired repeatedly to obtain the average of waveform data of the same timing (the same time in relation to the trigger point).

If this mode is active, the instrument takes the linear or exponential average of incoming data and writes the results into acquisition memory. The averaged data is then used to generate the display. You can set the attenuation constant to a value from 2 to 256 (in 2^n steps), and the averaging count to a value from 2 to 65536.

Exponential averaging(count=Infinite)

$$A_n = \frac{1}{N} \{(N-1)A_{n-1} + X_n\}$$

A_n : Value obtained after nth averaging

X_n : nth measured value

N : Attenuation constant
(2 to 256, in steps of 2^n)

Linear averaging(count=2 to 65536)

$$A_N = \frac{\sum_{n=1}^N X_n}{N}$$

X_n : nth measured value

N : Number of averaging times
(Acquisition count,
in steps of 2^n)

This averaging process is useful when you want to eliminate random noise.

Sequential Store

Refer to page 1-13.

Envelope mode

In normal mode and averaging mode, the sample rate (the number of times data is acquired per second in the acquisition memory) drops if T/div is increased (refer to Appendix 1 “Relationship between the time axis setting, sample rate and record length”). However, in the envelope mode, the maximum and minimum values are determined at every time interval from the data sampled at the maximum sample rate of each module. The time interval used to determine the values is equivalent to the sampling interval of the normal mode. The maximum and minimum values are paired and acquired in the acquisition memory.

Envelope mode is useful when you want to avoid aliasing (page 1-3), since the sample rate is kept high irrespective of the time axis setting (T/div). Furthermore, envelope mode is also useful when you want to detect glitches (pulsing signals which rise very fast) or display an envelope of a modulating signal.

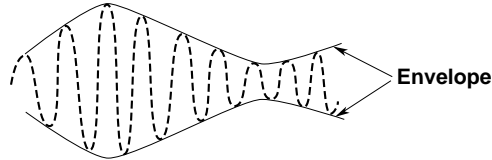

Box average

See below.

Sequential Store ≡ Page 7-4. ≡

Waveform data will be stored in the acquisition memory only a set number of times, and all waveforms can be displayed. This stops automatically after acquisition. The maximum acquisition count available with the feature varies according to the displayed record length. Once the specified number of waveforms have been stored, you can display any of the waveforms individually or all of them together, so that it is possible to derive a time series of the waveform variation. The drawings below illustrate how stored data can be displayed (assuming sequential storage of 100 waveforms).

Display example in case count=100 times

Displaying all waveforms (ALL)

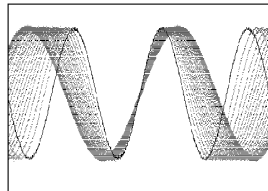

Displaying newest waveform (Selected Record No.=0)

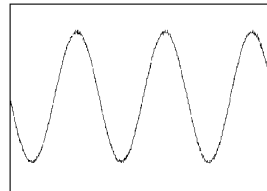

Displaying oldest waveform (Selected Record No.=99)

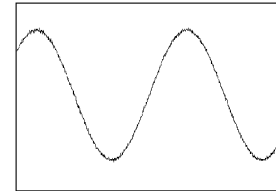

Box average ≡ Page 7-5. ≡

Taking the data sampled at 10 MS/s, the moving averages of certain number of data points are determined as shown in the following figure. These data are acquired in the acquisition memory and displayed. Box averaging is useful for eliminating the small amount of noise on the input signal. It is also effective in removing the noise from a signal acquired only once. Box averaging is only available on High-Speed Isolation/High-Speed Modules.

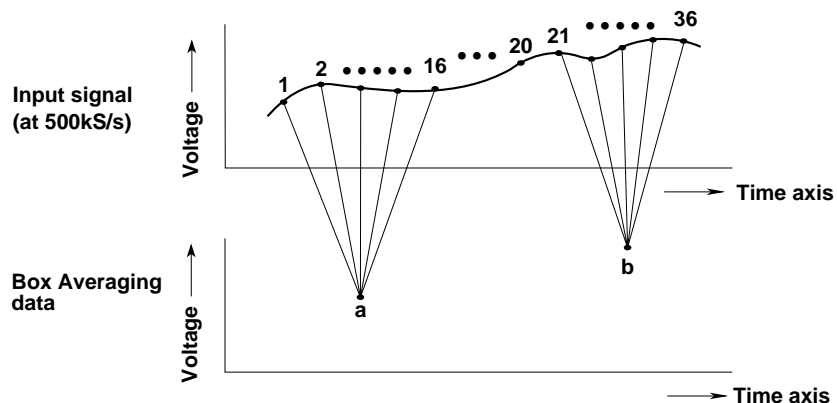

History Memory ≡ Page 7-6. ≡

The instrument automatically retains the last N waveforms recorded. The N value is equal to the maximum sequential-store acquisition count. The instrument retains all waveforms for the first N triggers; then, for each subsequent trigger, the instrument overwrites the oldest stored waveform. You are free to switch the display from the current (newest) waveform to any of other N-1 waveforms in the history. The illustration below shows how data can be displayed, assuming N = 100.

Saved waveform data of previous 100 triggers

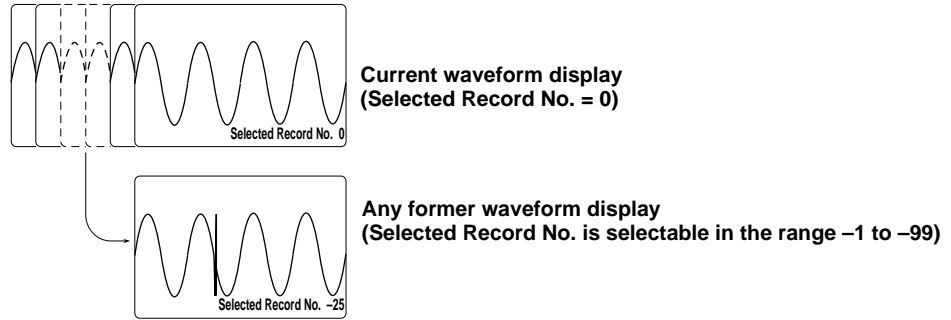

Realtime Recording ≡ Page 7-9 to 7-12. ≡

Realtime print to the built-in printer

The waveform (screen image data) can be printed to the built-in printer continuously like a recorder. Realtime print is possible when the time axis setting is “500 ms to 100 ks/div” and the sample rate is 100 kS/s or less. Even with the same time axis setting, the sample rate varies depending on the record length setting. For details refer to Appendix 1 “Relationship between the Time Axis Setting, Sample Rate and Record Length.”

The maximum feeding speed of the printer roll paper (chart speed) is 20 mm/s.

Realtime record to the internal hard disk (optional)

The data can be recorded in realtime to the internal hard disk (optional). The size of the recording area is 256 MB, and is allocated on the internal hard disk from the beginning. The realtime recording area is overwritten every realtime recording operation. After a realtime recording session, you can also save the data to another area so that they will not be overwritten. The saved data can be recalled (loaded). The record length and time axis setting that can be used for realtime recording are as follows.

| Channels used | Time axis setting | Possible record length |
|----------------------|--|------------------------|
| 8CH (all channels) | 10 s/div to 100 ks/div (10 kS/s or less) | 1 MW to 16 MW |
| 4CH (any 4 channels) | 5 s/div to 100 ks/div (20 kS/s or less) | 1 MW to 32 MW |
| 2CH (any 2 channels) | 2 s/div to 100 ks/div (50 kS/s or less) | 1 MW to 64 MW |
| 1CH (any 1 channel) | 1 s/div to 100 ks/div (100 kS/s or less) | 1 MW to 128 MW |

How the hard disk is used

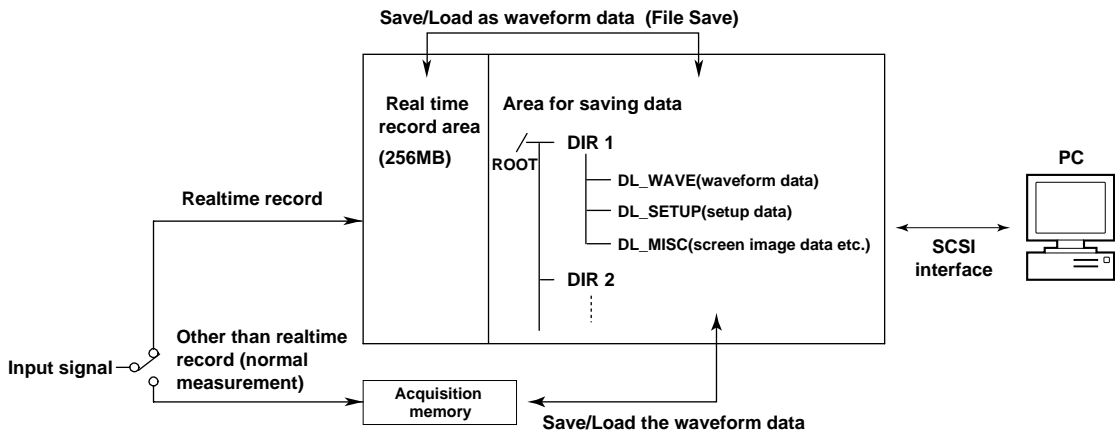

Display settings ≡ Chapter 8. ≡

Display format → page 8-1.

- In order to make the observation of waveforms of multiple channels easy, you can split the screen to display the waveforms. The different ways to split the screen are as follows: Single (no split screen), Dual (2 screens), Triad (3 screens), Quad (4 screens), Hexa (6 screens), Octal (8 screens).
- You can select how to assign the waveforms to the split screens from the following choices.
 - Auto : Assign the channels with the display turned ON in order from the top screen.
 - Fixed : Assign the channels in order from the top, regardless of whether or not the channel display is turn ON.
 - User : Arbitrarily assign the channels to the split screens, regardless of whether or not the channel display is turn ON.

Graticule → page 8-4.

Use this feature to select use of grid, frame, or “cross” graticule.

Extra window → page 8-7.

This feature displays an “extra window” showing the various measurement values (cursor values and automatically measured values). This feature is useful in cases where it is difficult to read the values directly from the waveform.

Scale values and trigger mark → page 8-8.

If the Scale Value setting is ON, the screen displays numerical values at the top and bottom of the vertical axis. If the Trigger Mark is ON, the screen displays a marker indicating the trigger point.

Waveform labels → page 8-9.

You can assign an arbitrary label (up to 8 characters) to each waveform.

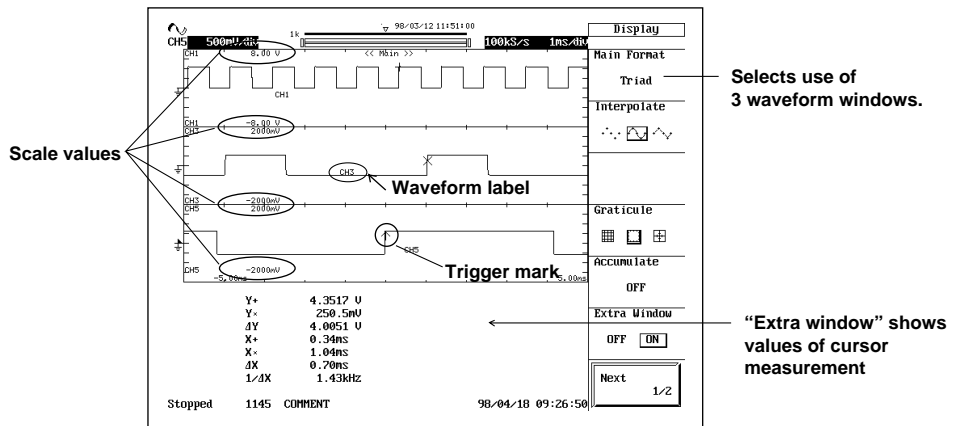

Display Interpolation ≡ Page 8-2. ≡

This feature selects the type of interpolation applied in areas where there are less than 500 sample points per 10 time-axis divisions. (These areas are referred to as interpolation areas.) Three settings are available.

Line interpolation

Interpolates between two dots using a straight line.

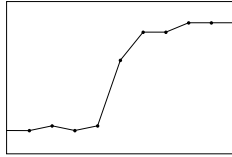

Sine interpolation

Generates interpolation data using the function $\sin(x)/x$ then interpolates between two dots using resulting sine curve. Sine interpolation is suitable for observation of sine waves.

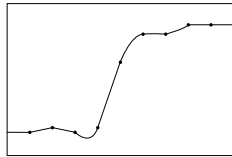

No interpolation

Displays measurements as discrete dots, without interpolation.



Note

-
- If interpolation is set OFF, you can use any of the following compression methods to display data in the non-interpolation areas.
 - P-P: Selects use of P-P compression.
 - Decim: Displays data at intervals.
 - All: Displays all values.
 - If interpolation is set to Sine or Line, the unit will always use P-P compression for data display in non-interpolation areas.
-

Accumulated Waveform Display ≡ Page 8-5. ≡

This mode holds each waveform on the screen for a time that is longer than the update cycle, so that multiple waveforms are overlapped.

The following two modes are available.

- Persist : Overlaps the display of waveforms using one color.
- Color : Overlaps the display of waveforms using 8 colors which signify the frequency of occurrence of the data values.

This function is useful when you want to observe jitters and temporary turbulence in waveforms.

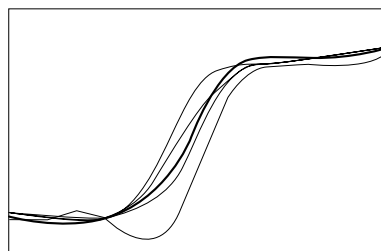

X-Y Waveform Display ≡ Page 8-10. ≡

This feature plots the voltage values of one input waveform (on the X axis) against the voltage values of the others (on the Y axis, which have their display turned ON). The X-Y plot lets you view the relationship between the signal voltages. The X-Y waveforms and normal waveforms (a waveform displayed using voltage and time axes) can be displayed simultaneously. Use of this X-Y waveform display function enables measurement of the phase angle between two sine wave signals. For example, two X-Y sine waveforms are displayed to obtain an X-Y waveform (called a Lissajous waveform), from which the phase angle can be obtained.

Lissajous waveform

| | | | |
|-----------------------|-----|-----|-----|
| Phase angle 0° | | | |
| Phase angle 45° | | | |
| Phase angle 90° | | | |
| Frequency ratio (X:Y) | 1:1 | 1:2 | 1:3 |

Expanded Waveform ≡ Page 8-12. ≡

The displayed waveform can be enlarged in the time axis direction. This function is useful when the acquisition time of the waveform is set long and you wish to observe the details of a section of the waveform, or when you wish to change the time axis setting after displaying the waveform with Single Start/Log Start methods (refer to page 4-6). Zooming is not available on areas with less than 11 data points. You set the zoom position according to its time-axis location.

Zoom display arrangement

You can display one or two zoom windows on the screen. Four display arrangements are available, as follows.

Main : Main area

Z1, Z2 : Zoom area

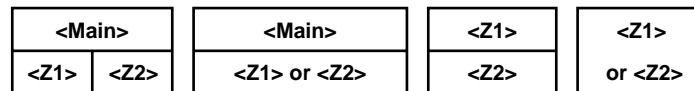

If you display the “main” area (normal waveform display) together with one or both zoom windows, the main area will include vertical lines (or “zoom boxes”) indicating the zoom area(s). The center of the zoom area corresponds to the center of the zoom box.

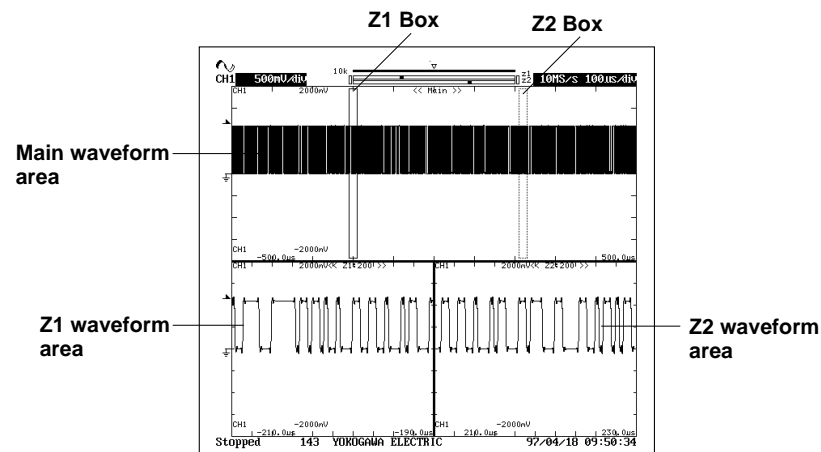

Moving the display position of the waveform data ≡ Page 8-12. ≡

When the display record length is shorter than the set record length, some of the waveforms are not displayed on the screen. To display the waveforms that are not displayed on the screen, move the display position horizontally with “Main Position.”

The maximum record length that can be displayed on the screen is 1 MW.

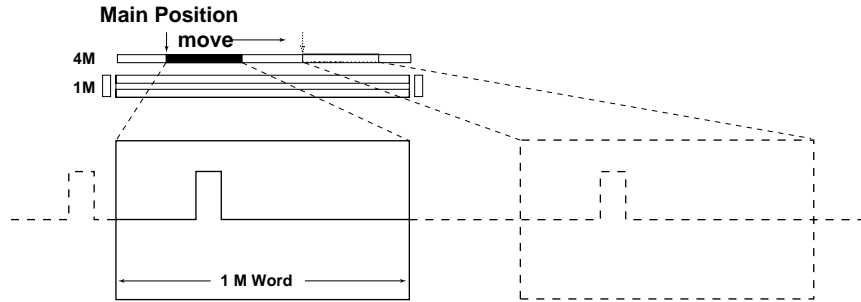

1.5 Analyzing the Waveform

Linear Scaling ≡ Page 5-12. ≡

It is possible to append a scaling constant A, an offset value B and a unit to the measurement value X of cursor or automated measurements. Linear scaling is useful, when applying a voltage divider ratio to the measurement values. Linear scaling is also handy when you want to your scope to automatically convert the measured voltage results into the (for example, current or temperature) measurement unit of your signal source.

$$Y(\text{UNIT}) = AX + B \quad Y = \text{result of linear scaling}$$

Cursor Measurements ≡ Page 9-1. ≡

You can use the following cursor types to analyze the waveform data.

- V cursors
Two vertical broken lines (V cursors) are displayed. The time from the trigger position to each V cursor and the time difference between the V cursors are measured.
- H cursors
Two horizontal broken lines (H cursors) are displayed. The values in the vertical direction of each H cursor and the difference between the two are measured.
- Markers
Use this feature to place one or two markers onto the waveform. You can then read the voltage value and time value (relative to trigger position) at each marker, and the voltage difference and time span between the markers.

For markers

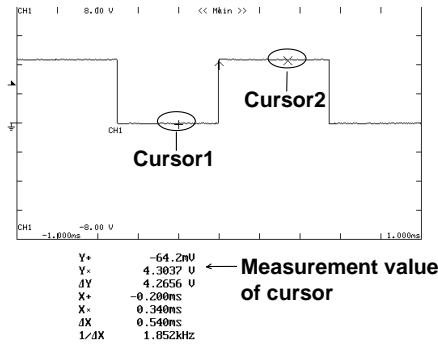

For V-cursors

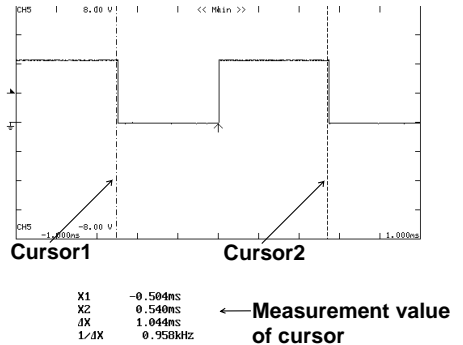

- User defined cursors
You can assign reference points, the zero point and the end point, on the time axis and measure the relative positions of the two V cursors with respect to the reference. You can arbitrarily set the reference width from the zero point to the end point and the unit of measurement within a certain range.

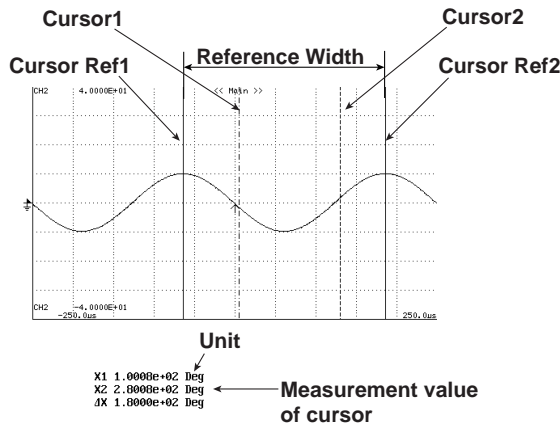

Automated Measurements ≡ Page 9-4. ≡

Automatic measurement of waveform parameters

This feature automatically measures selected waveform parameters, such as rise time and pulse width. You can select parameters separately for each channel, although you are limited to a total of 8 parameters for the entire system. There are 26 parameters available for selection.

Statistical processing

You can perform statistical processing on any one of the parameters selected for automatic measurement, based on a specified number of acquisitions.

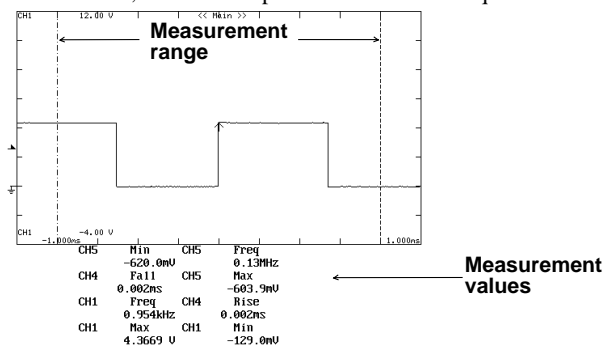

Waveform Math ≡ Chapter 9. ≡

Simple computation (BASIC mode) → page 9-10.

Adds, subtracts, or multiplies two waveforms (Channels 1 and 2, 1 and 5, 1 and 3, or 3 and 7). Results are displayed as waveform Math1 or Math2.

Addition and subtraction are useful for phase comparison, signal-logic checking, and for comparison with the reference signal. Multiplication is useful for checking power signals created by simultaneous input of voltage and current signals.

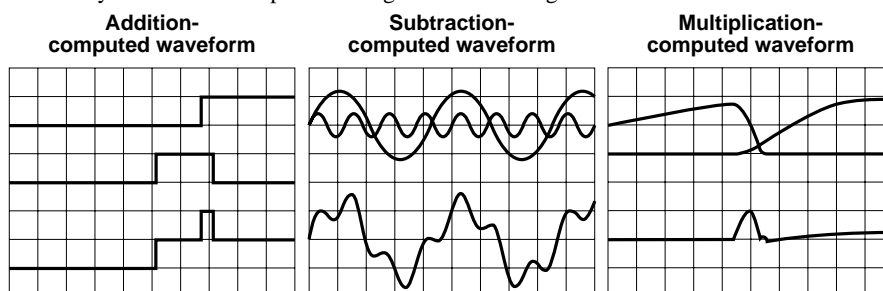

Binarization (BASIC mode) → page 9-11.

Converts selected waveform into a binarized waveform. All voltages below the threshold become 0, while voltages above the threshold become 1. This operation is available for Channel 1, Channel 2, and the Math1 waveform.

Phase-shifted computation (PHASE mode) → page 9-13.

Executes a phase shift of either Channel 2, 3, 5, or 7 (with respect to Channel 1), then adds, subtracts, or multiplies the result against the Channel 1 waveform.

All-channel binarization and D/A conversion (BINARY mode) → page 9-15.

Binarizes waveforms on all channels: all values below the threshold become 0, Voltages above the threshold become 1. You can choose to generate an analog waveform through exponential summation of the binarized waveforms.

Scaling of Math1 and Math2 waveforms → page 9-18.

The instrument normally auto scales when displaying the computed waveform, but manual scaling can also be selected.

If you select auto scaling, the most suitable scaling value for displaying the waveform is determined from the maximum and minimum values of the computed result.

If you select manual scaling, then the upper and lower limits of the computed waveform display can be set to any desired values.

Note

Waveform computation cannot be performed on channels that have logic input modules installed.

Power Spectrum Display ≡ Page 9-17. ≡

FFT (Fast Fourier Transform) computation can be performed on the input signal to display its power spectrum. This is useful when you want to check the frequency distribution of the input signal.

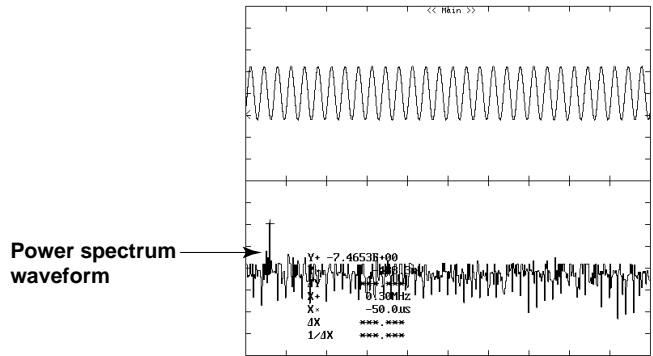

The following windows are available: rectangular/Hanning/flattop windows. The rectangular window is effective for transient signals, such as an impulse wave, which attenuate completely within the time window. The Hanning window allows continuity of the signal by gradually attenuating the parts of the signal located near the ends of the time window down to the "0" level. Hence, it is effective for continuous signals. With the Hanning window, the accuracy is relatively low, but the frequency resolution is relatively high. The frequency resolution of the flattop window is less than that of the Hanning window. However, the flattop window has the advantage of high level accuracy. FFT computation generates 1000, 2000 or 10000 measurement data points, but only half points are displayed on the screen.

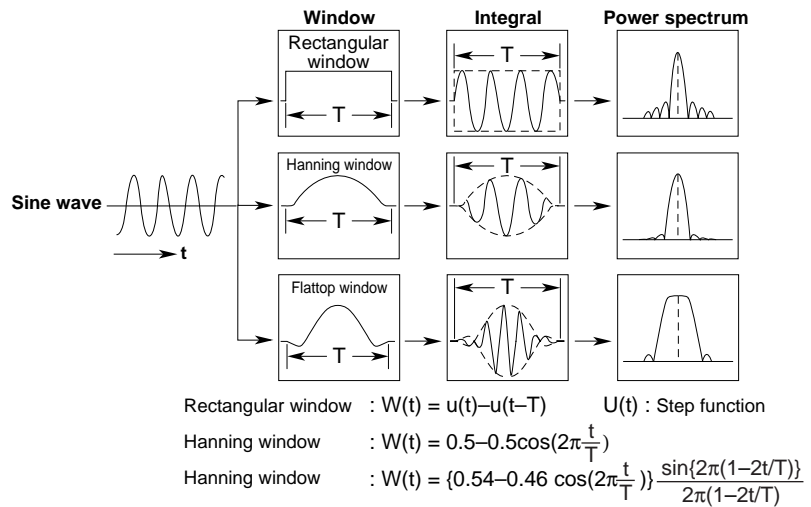

[FFT function]

When the complex result of FFT computation is $G = R + jI$, the power spectrum can be expressed as follows.

$$\text{Power spectrum} = 10 \log \left(\frac{R^2 + I^2}{2} \right)$$

R : Real Part I : Imaginary Part
 Reference (0dB) for Log magnitude: : $1V_{rms}^2$

User Defined Computation ≡ Page 9-19. ≡

You can define a computing equation by combining the following operators. ABS(absolute value), SQR(square root), LOG(logarithm), EXP(exponent), BIN(binary computation), PWHH(pulse width), PWHL(pulse width), PWLH(pulse width), PWLL(pulse width), PWXX(pulse width), ATAN(arctangent), MEAN(moving average), DIF(differentiation), DDIF(2nd order differentiation), INTG(integral), IINTG(double integral), PH(phase), HLBH(Hilbert), P2(square), P3(cube), FILT1(digital filter), FILT2(digital filter), LS-(linear spectrum), RS-(rms value spectrum), PS-(power spectrum), PSD-(power spectrum density), CS-(cross spectrum), TF-(transfer function), CH-(coherence function), PHASE(phase), REAL(real part), IMAG(imaginary part), LOGMAG(logarithm magnitude), MAG(magnitude), SIN(sine), COS(cosine), TAN(tangent), F1($\sqrt{C1^2 + C2^2}$)*, F2($\sqrt{C1^2 - C2^2}$)*, variable T.

* This function is available on DL708Es with firmware versions 4.00 or later.

In addition, you can average or compute the peak value on the computed data. Four operations are available: linear, exponential, cycle, and peak.

Linear averaging

Simply sum the data for the average count (number of acquisitions, 2 to 128, 2ⁿ steps) and divide by the average count. The resulting waveform is displayed. See page 1-12 for the equation.

Exponential averaging

Determine the average value by attenuating the influence of past data using the specified attenuation constant (2 to 256, 2ⁿ steps). The resulting waveform is displayed. See page 1-12 for the equation.

Cycle averaging*

Divide one period of computed data into the specified number of data points (Cycle Count). Do this across multiple periods of data from the start to the end position of the computation. Determine the average of the data points at the same position across multiple periods. The resulting waveform is displayed. In the following example, the Cycle Count is set to 720 and the result of the cycle average is displayed.

* This function is available on DL708Es with firmware versions 3.00 or later.

<Computed data>

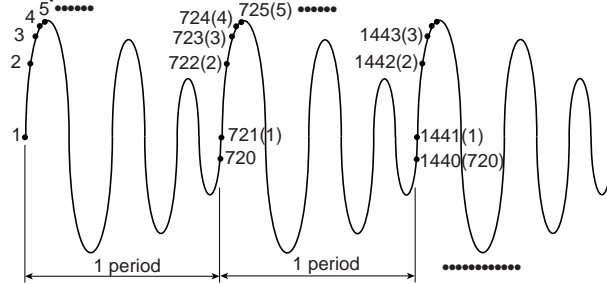

<Cycle averaging result>

Determine the simple average of the data points at the same position across multiple periods and display the waveform.

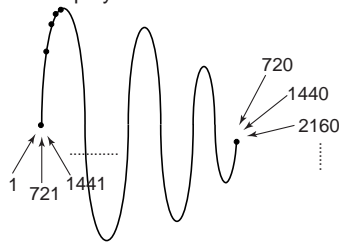

Peak computation*

Determine the maximum value at each point of the computed data and display the waveform. For each computation, the new computed value is compared with the past value and the larger value is kept.

* This function is available on DL708Es with firmware versions 3.00 or later.

Three FFT data

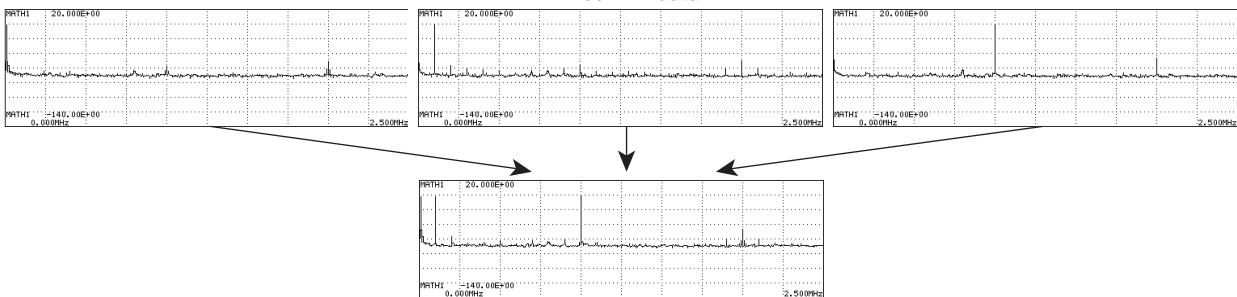

Display the maximum value at each point

1.6 Other Useful Functions

Initialization ≡ Page 4-3. ≡

This function resets the key settings to the factory settings (default settings), and is useful when complex settings have been made and you want to cancel all of them at once.

Auto Set-up ≡ Page 4-4. ≡

This function makes settings automatically such as vertical sensitivity, time axis and trigger settings, to suit the signal to be measured. This is useful when the signal to be measured is unknown. However, there might be particular signals for which the auto set-up function may not work properly.

Snapshot ≡ Page 4-8. ≡

If single start or log start is not selected, a waveform is updated at the specified intervals or is displayed in roll mode. Thus, to retain the currently displayed waveform, acquisition must be stopped. Use of the snapshot function allows the currently displayed waveforms to remain temporarily on the screen without acquisition being stopped. To activate this function, just press the SNAP SHOT key without stopping acquisition. The currently displayed waveform will be retained. This waveform is called a snapshot waveform. The snapshot waveform is displayed with a white color from that used for the updated waveform, making comparison between the two easier.

Cursor measurements, automatic measurement of waveform parameters, and saving of the data cannot be done on the snap shot waveform, because it is a screen image data. However, screen image data output (hard copy) is possible.

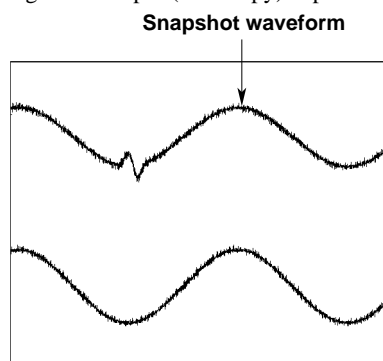

Clear Trace ≡ Page 4-8. ≡

This function enables you to clear snapshot waveforms and accumulated waveforms, and restart the averaging process or repetitive sampling in a single operation.

Displayed-data output functions ≡ Chapter 10. ≡

You use these functions to print the screen image to the built-in printer, to save the image data to disk or other storage medium, to plot the image on an external HP-GL compatible plotter, or to print the image to the centronics printer.

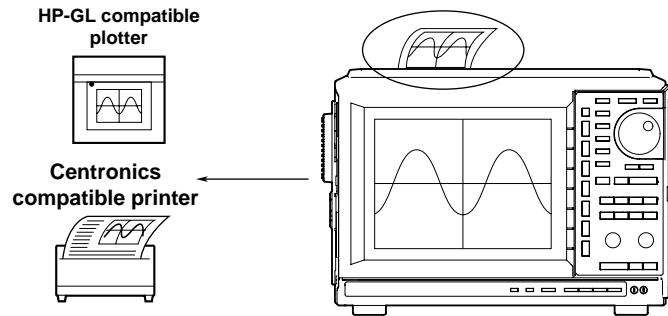

Note

The instrument provides a function which enables you to use the keyboard displayed on the screen to enter and display a comment. If you enter a comment which indicates the contents of the displayed waveforms before printing a hard-copy, it will help you to distinguish between different print-outs.

Disk saves and loads ≡ Chapter 11. ≡

The instrument standard configuration includes a built-in floppy drive. You can also choose to install an optional hard disk. It is also possible to save data to an external SCSI device. You can save data in any of the following formats: HP-GL command format, Postscript, TIFF, and BMP. This means that you can easily insert the saved images into documents produced by conventional DTP software packages.

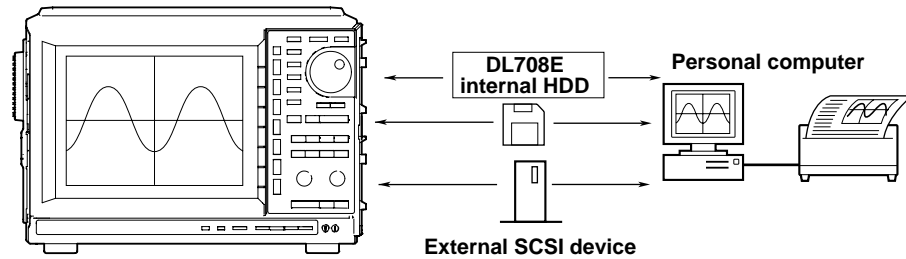

Action on trigger ≡ Page 13-5. ≡

The specified action from the following choices is carried out each time the trigger is activated.

- Sound a buzzer
- Save the waveform data to the specified media
- Output the screen image data to the specified media

Communications ≡ Interface User's Manual (IM 701820-11E). ≡

The instrument is equipped with a GP-IB/RS-232 interface as standard. The interface enables you to send waveform data to a personal computer for analysis, as well as to perform waveform measurement while controlling the instrument using an external controller.

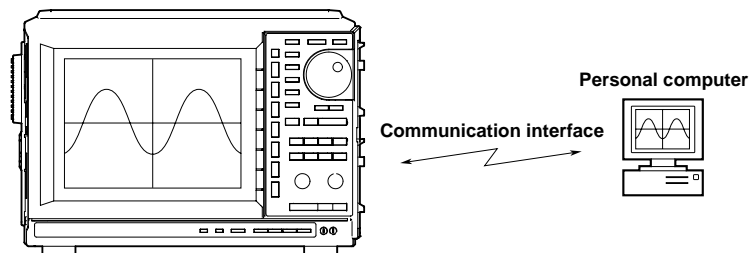

2.1 Front Panel/Rear Panel

• Front panel

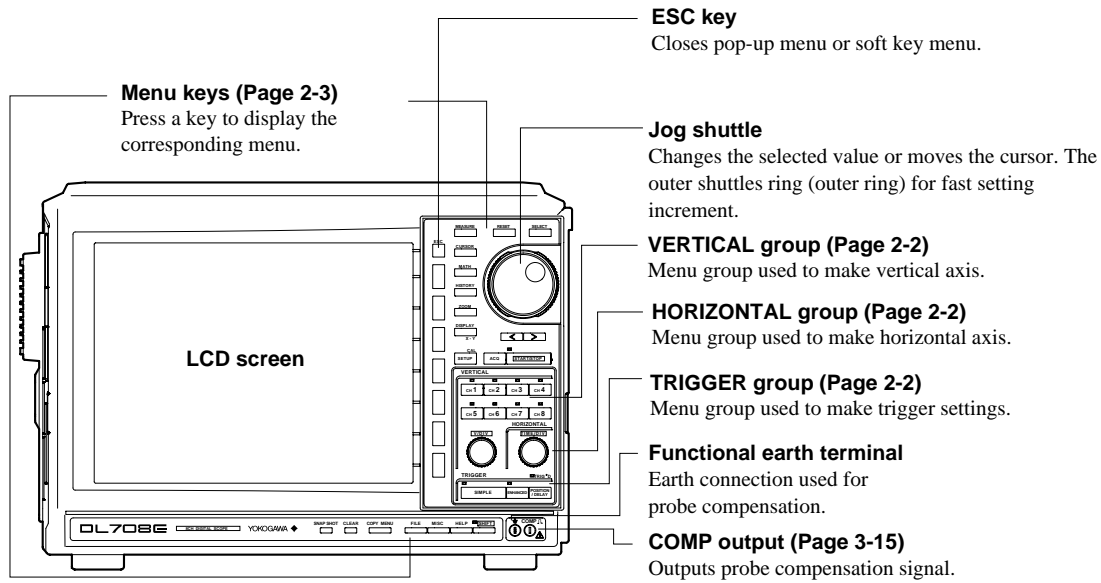

• Side panel

GP-IB connector

Connects to external plotter. (Page 10-8)
For details about communication functions, refer to the instrument Communication Interface Manual (IM 701820-11E).

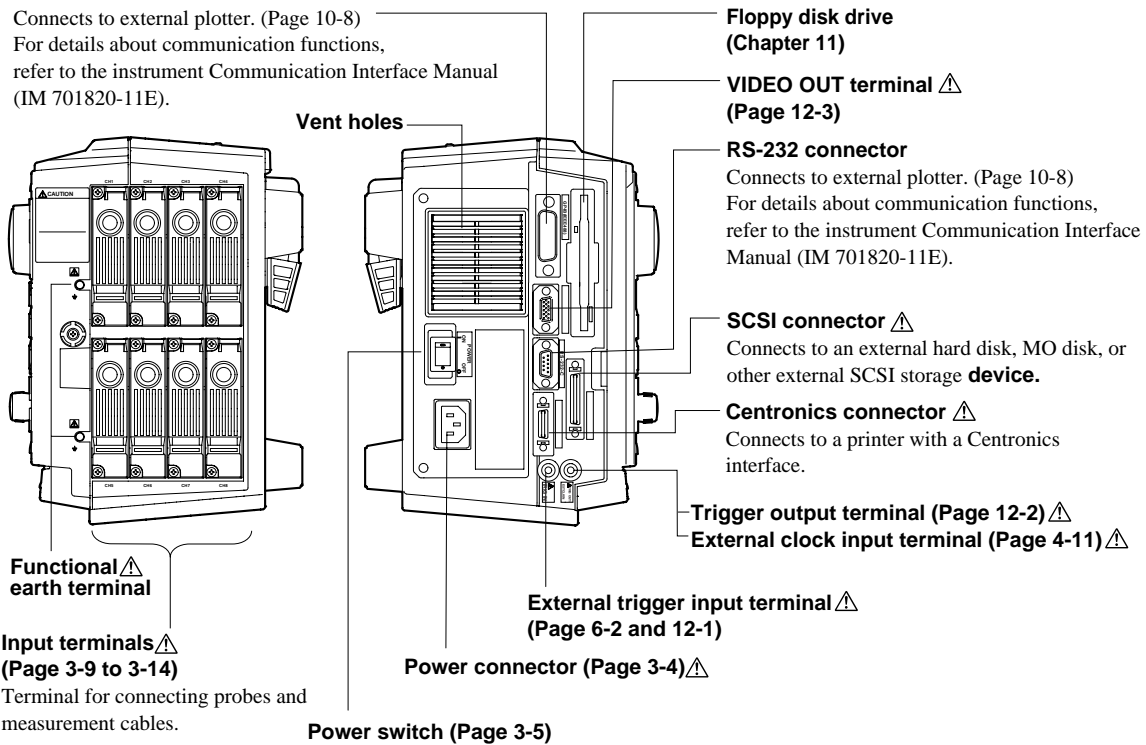

• Top view

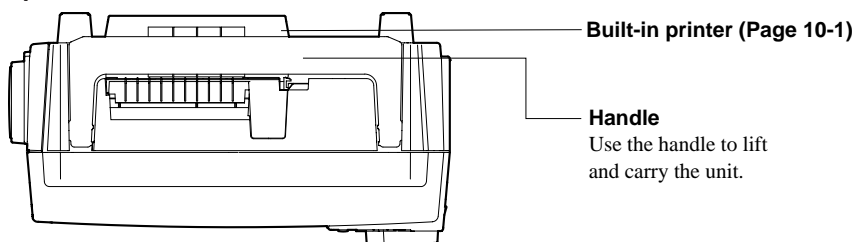

2.2 Operation Keys/Jog Shuttle/Knobs

VERTICAL Group

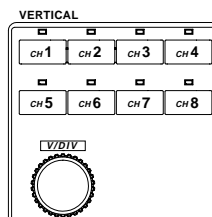

Keys CH1 to CH8 keys (Pages 5-1 to 5-17)

Displays the menu for setting the ON/OFF state, offset voltage, coupling, probe attenuation, preset, bandwidth limit, invert, linear scaling value for each channel. Also, it allows you to select the channel to operate with the V/div knob (for voltage modules only). When the display is turned ON, the LED above the key lights up.

V/DIV knob (Page 5-4)

Sets the voltage axis sensitivity. Before turning this knob, be sure to select the channel you want to adjust by pressing the corresponding channel key (CH1 to CH8).

If you change the scale while acquisition is suspended, the new value becomes effective when acquisition resumes.

This knob is applicable only to channels which have the voltage module installed.

HORIZONTAL Group

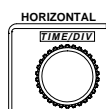

TIME/DIV knob (Page 5-2)

Use this knob to set the time scale. If you change the scale while acquisition is suspended, the new value becomes effective when acquisition resumes.

TRIGGER Group

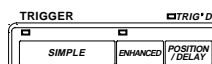

SIMPLE key (Pages 6-1 to 6-9)

Displays the menu for the simple trigger, which triggers on a single trigger source. Simple trigger mode is selected when the indicator located above this key is lit.

ENHANCED key (Pages 6-1 to 6-8 and 6-10 to 6-20)

The enhanced trigger menu for setting complex triggers such as A→B(n) trigger, is displayed. Enhanced trigger mode is selected when the indicator located above this key is lit.

POSITION/DELAY key (pages 6-6 to 6-8)

Use this key to set the trigger position or trigger delay.

TRG'D indicator

Lights up when a trigger is activated.

Other Menus

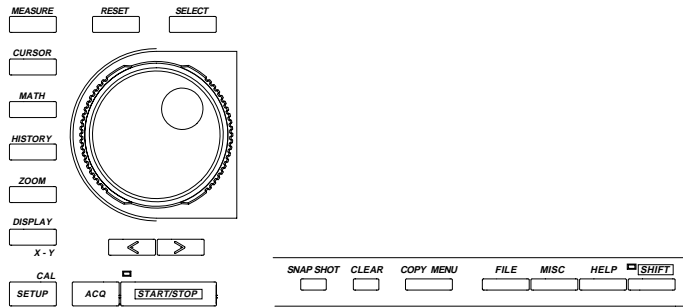
**MEASURE key (Pages 9-4 to 9-8)**

Displays the menu for performing automatic measurement of waveform parameters.

CURSOR key (Page 9-1)

Displays the menu for cursor measurement.

MATH key (Pages 9-9 to 9-23)

Displays the menu for waveform computation.

HISTORY key (Page 7-6)

Displays the menu for recalling data from the history memory.

ZOOM key (Page 8-12)

Displays menu for zoom setup.

DISPLAY key (Chapter 8)

Displays the screen display menu.

Press **SHIFT+DISPLAY** to produce the menu for X-Y display setup.

SETUP key (Page 4-3 and 4-4)

Displays the auto setup menu which automatically sets the keys to the appropriate values with respect to the input signal and the initialize menu which resets the key settings to their factory setting values. If you press the **SHIFT + SETUP**, the screen displays the calibration menu.

ACQ key (Chapter 7)

Displays the acquisition method menu.

START/STOP key (Page 4-6)

Starts or stops acquisition according to the selected trigger mode. The indicator above this key is lit during acquisition.

Jog and shuttle dials (“jog shuttle”)

You use these dials to set numerical values, move the measurement cursors, select items from menus, and perform other such selection operations.

The jog dial changes the value in fixed steps as you rotate it. With the shuttle dial, the step size increases as you turn the dial further.

RESET key

Resets values that you have changed using the jog and shuttle dials.

SELECT key

Activates the menu item that you have highlighted using the jog or shuttle dial.

Arrow keys (< > keys)

Use these keys to shift the column position of the numerical value to be set by the jog or shuttle dial.

SNAP SHOT key (Page 4-7)

Repeats acquisition while retaining the currently displayed waveform on the screen.

CLEAR key (Page 4-7)

Deletes the currently displayed waveform.

***COPY* key (Chapter 10)**

Used for printing out hard copy of the screen data.

If you press ***SHIFT+COPY***, the screen displays a menu that you can use to print or save the screen image. For the save location, you can select any of the following: internal printer (optional), GP-IB interface, or storage medium (floppy, MO, or external SCSI).

***FILE* key (Pages 11-4 to 11-18)**

Displays menu that you use to save to, load from, or execute file operations on floppy disk, MO disk, or external SCSI device.

***MISC* key (Pages 3-6, 3-8, 11-19; Chapter 13; IM 701820-11E)**

Displays the menu for selecting GO/NO-GO judgment, GP-IB interface, system configuration settings, system status check, screen saver setting, and the self-diagnostic function.

***SHIFT+CLEAR* key (IM701820-11E)**

Clears the remote state.

***HELP* key (Page 4-9)**

Sets help window ON or OFF.

***SHIFT* key**

Used to make the functions that are marked in purple on the panel operative. Pressing this key activates shift mode, pressing it again releases shift mode. While the indicator above this key is lit, the shift mode is active.

2.3 Screens

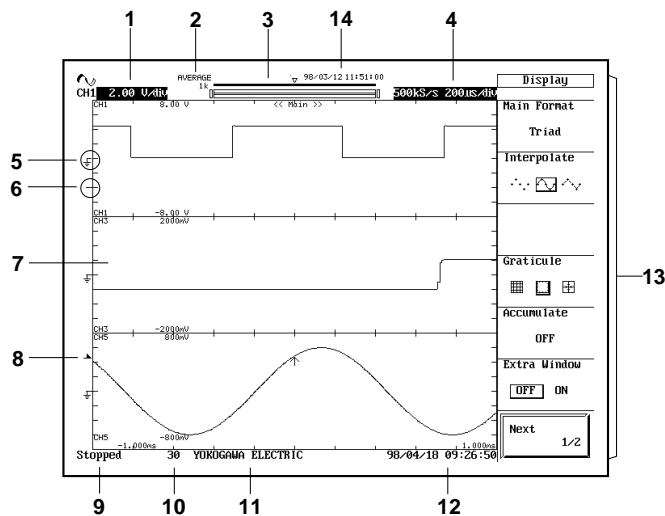

1 V/div

Displays the voltage axis sensitivity of the selected channel.

2 Acquisition mode

Displayed when the acquisition mode is averaging, envelope, or box average.

3 Screen position bar

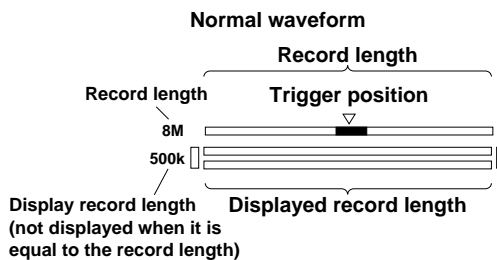

4 T/div, sample rate

The sample rate varies according to the T/div setting and the record length.

5 Ground level

6 Vertical position

7 Display format

The waveform display screen can be divided into 1, 2, 3, 4, 6 or 8 sections. (Refer to page 8-1.)

8 Trigger level

9 Acquisition state

Running : Acquisition is in progress.

Auto Calibration : Auto calibrating.

Stopped : Acquisition is stopped.

Waiting for trigger

10 Number of acquisitions

The number of acquisitions performed is displayed.

11 Comment

Displays a comment which will be added when screen data is output to, for example, the built-in printer.

12 Date/time

For adjustment of the date/time, refer to "3.4 Setting the Date and Time".

13 Soft key menu

14 Date/time of completion of the data acquisition

Note

- The instrument's color LCD display has a defective pixel ratio of approx. 0.02%.
- The mark "*" flickers on upper left of the display in the following case.
 - Green * : Computation in progress
 - Red * : Display update in progress
 - Yellow * : Automatic measurement of waveform parameter in progress

3.1 Precautions During Use

Safety Precautions

When you are using this instrument, read the “Safety Precautions” given on page 5 thoroughly, as well as the following points:

Do not remove the cover from the instrument

Some parts of the instrument use high voltages, which are extremely dangerous. When the instrument needs internal inspection or adjustment, contact your dealer or nearest YOKOGAWA representative, as listed on the back cover of this manual.

In case of irregularity

If you notice smoke or unusual odors coming from the instrument, immediately turn OFF the power and unplug the power cord. If such an irregularity occurs, contact your dealer or the nearest YOKOGAWA representative, as listed on the back cover of this manual.

Power cord

Nothing should be placed on the power cord; also, it should be kept away from any heat sources. When unplugging the power cord from the AC outlet, never pull the cord itself. Always hold the plug and pull it. If the power cord is damaged, contact your dealer. Refer to page 2 for the part number to use when placing an order.

General Handling Precautions

Observe the following precautions when handling the instrument.

Never place anything on top of the instrument

Never place other equipment or objects containing water on top of the instrument, otherwise a breakdown may occur.

Do not cause shock to the input connectors or probes

Shock to the input connectors or probes may turn into electrical noise and enter the instrument via the signal lines.

Do not damage the LCD screen

Since the LCD screen is very vulnerable and can be easily scratched, do not allow any sharp objects near it. Also it should not be exposed to vibrations and shocks.

When the instrument is not going to be used for a long period, unplug the power cord from the AC outlet

When moving the instrument

Disconnect the power cord and connecting cables. Always carry the instrument by the handles as shown below.

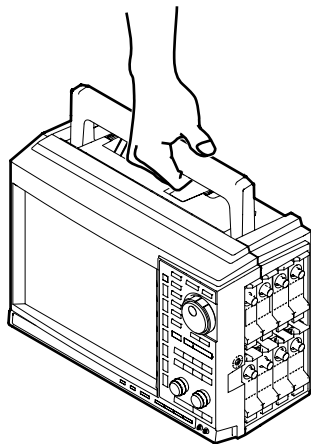

Cleaning

When cleaning the case or the operation panel, unplug the power cord from the plug first, then wipe with a dry, soft, clean cloth. Do not use volatile chemicals such as benzene or thinner for cleaning, as this may lead to discoloration or deformation.

3.2 Installing

Installation Conditions

The instrument must be installed in a place where the following conditions are met.

Flat horizontal location

Set the instrument in the proper direction and in a level and stable place. If placed in an uneven or unstable place, printing quality decreases. Note that the instrument can be tilted on the stand.

Well-ventilated location

Vent holes are situated on the bottom side of the instrument. In addition, vent holes for the cooling fans are also situated in the left side. To prevent a rise in the internal temperature, the vent holes should not be blocked and sufficient clearance should be maintained around them.

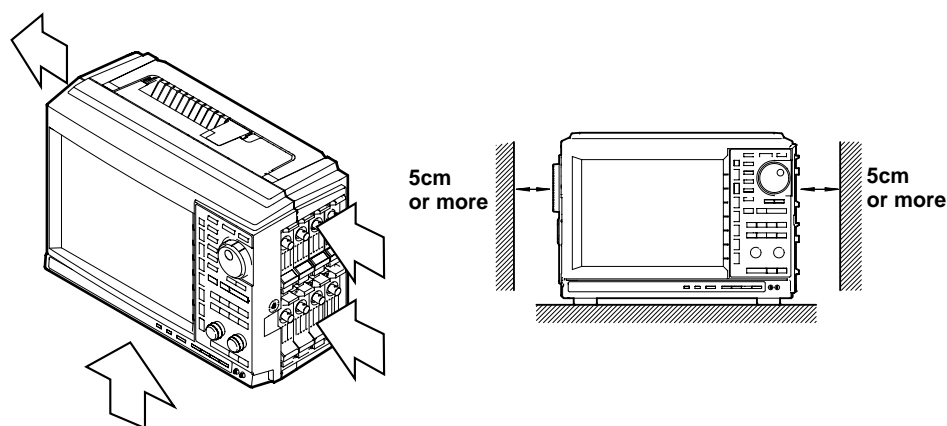

When connecting the various cables or when opening or closing the built-in printer cover, take extra space in addition to the space indicated above for the operation.

Ambient temperature and humidity

Ambient temperature: 5 to 40°C

Ambient humidity: 20 to 80% RH (when not using the printer)

35 to 80% RH (when using the printer)

No condensation should be allowed.

Note

- To ensure high measurement accuracy, the instrument should only be used under the following conditions.
Ambient temperature: $23 \pm 5^\circ\text{C}$
Ambient humidity: $55 \pm 10\% \text{ RH}$
- Internal condensation may occur if the instrument is moved to another place where both the ambient temperature and humidity are higher, or if the temperature changes rapidly. In such cases allow the instrument to acclimatize to its new environment for at least one hour before starting operation.

Never install the instrument in the following places.

In direct sunlight or near heat sources

Where an excessive amount of soot, steam, dust or corrosive gases are present.

Near magnetic field sources

Near high voltage equipment or power lines

Where the level of mechanical vibration is high

In an unstable place

Installation Position

Place the instrument in a horizontal position or with the rear panel facing down as shown in the figure below. When using the stand, pull it until it locks. When not in use, push the stand inwards to its original position.

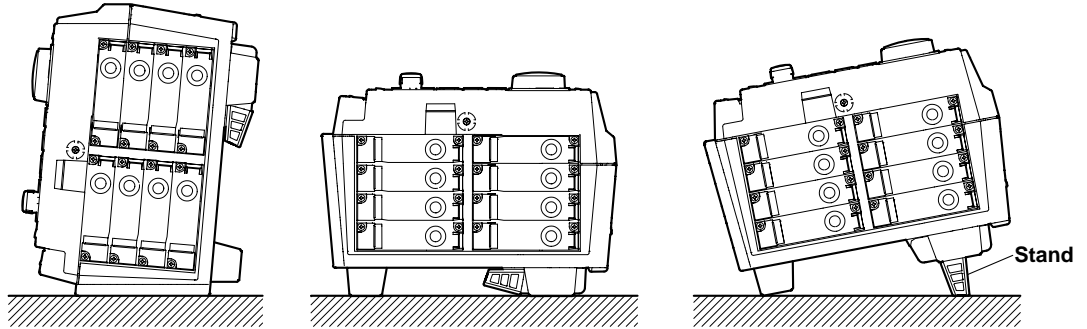

Rubber feet

When using the instrument in a horizontal position, attach four rubber stoppers to the feet to prevent the instrument from sliding.

3.3 Connecting the Power Cord

Before Connecting the Power

Make sure that you observe the following points before connecting the power. Failure to do so may cause electric shock or damage to the instrument.



WARNING

- Connect the power cord after confirming that the voltage of the power supply complies to the rated electric power voltage for the instrument.
- Connect the power cord after confirming that the instrument power switch is OFF.
- Always use protective earth to prevent electric shock. Connect the instrument power cord to the 3-pin power outlet with earth terminal.
- Do not use non-earth extension cords or other measures that defect the protective earth.
- Never use an extension cord that does not have a protective earth, otherwise the protection feature will be invalidated.

Connecting the Power Cord

1. Make sure that POWER switch is OFF.
2. Connect the plug of the accessory power cable to the power connector on the left side of the instrument.
3. Plug the other end of the power cord into an AC outlet that meets the following conditions.
The AC outlet must be of 3-pin type with a protective earth terminal.

| Item | Suffix-1 | Suffix-5 |
|--|----------------|----------------|
| Rated supply voltage | 100 to 120 VAC | 200 to 240 VAC |
| Permitted supply voltage range | 90 to 132 VAC | 180 to 264 VAC |
| Rated supply voltage frequency | 50/60 Hz | 50/60 Hz |
| Permitted supply voltage frequency range | 48 to 63 Hz | 48 to 63 Hz |
| Maximum power consumption (when the built-in printer is used) | 250 VA | 250 VA |

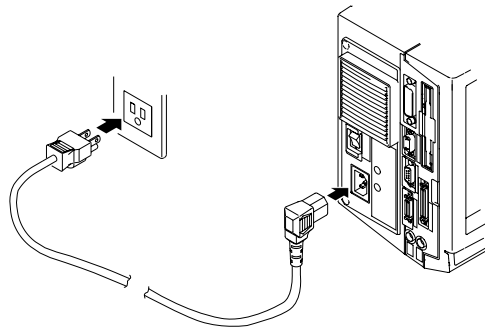

Turning the Power ON or OFF

Items to be checked before turning ON the power

Check that the instrument is installed correctly as instructed in Section 3.2 “Installing” (page 3-2).

Check that the power cord is connected correctly as shown in Section 3.3 “Connecting the Power Cord” (page 3-4).

Turning the power ON/OFF

Pressing the power switch on the left side of the instrument to the “ON(|)” side, turns the power ON. Pressing it to the “OFF(O)” side turns the power OFF.

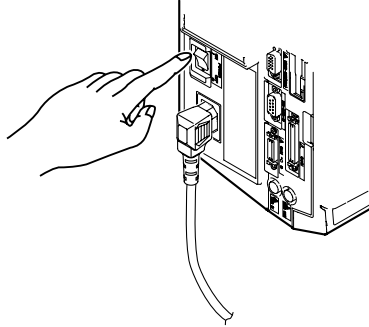

Response at Power ON

Self test and calibration start automatically when the power switch is turned ON. It takes approximately 30 seconds; if the check results are satisfactory, the normal waveform display screen will appear.

Note

If calibration does not start when the power is turned ON, or if the normal waveform display screen does not appear, check the following points.

- Check that the power cord is plugged in properly.
- Check that the correct voltage is being supplied from the AC outlet. (Refer to page 3-4.)
- If the power switch is turned ON while the INITIALIZE key is pressed, all settings will be reset to the factory settings. For details, refer to Section 4.2 “Initializing Settings” (page 4-3).

If there is still no power even after the above points have been checked, contact your nearest YOKOGAWA representative as listed on the back cover of this manual.

For Accurate Measurement

Turn the power switches ON and allow the unit to warm up for at least 30 minutes. After warm-up is complete, perform calibration. (Refer to Page 4-9.)

Response at Power OFF

Settings made prior to turning OFF the power are retained (even if the power cord is removed). This allows display of waveforms using those saved settings the next time the power is turned ON.

Note

The settings are backed up by a lithium battery. The battery lasts for approximately 5 years if it is used at an ambient temperature of 23°C. When the battery voltage drops below the specified level, a message will appear on the screen when the power is turned ON. If this message is displayed frequently, the lithium battery needs to be changed quickly. The battery cannot be replaced by the user, so contact the nearest YOKOGAWA representative listed on the back cover of this manual.

3.4 Setting the Date and Time

Function

Date (YY/MM/DD)

The last two digits of the year are used to set the year (YY).

Years 2000 to 2079 are represented by 00 to 79, and years 1980 to 1999 are represented by 80 to 99.

Time (HH:MM:SS)

The 24-hour clock is used.

Note

- The date and time are backed up by the built-in lithium battery.
- Leap years are taken into account.

Operating Procedure

Displaying the System Configuration Menu

1. Press the **MISC** key.
2. Press the **“System Config”** soft key to display the system configuration setting menu.

Setting the Date and Time

3. Press the **“Date”** soft key to display the keyboard.
4. Enter the current date as described on page 4-2.
5. In the same way, press the **“Time”** soft key and enter the current time.

Turning the Date/Time Display ON/OFF

3. Press the **“Date & Time”** soft key to select either ON or OFF. The date and time will be displayed on the screen if ON is selected, and will not be displayed if OFF is selected.

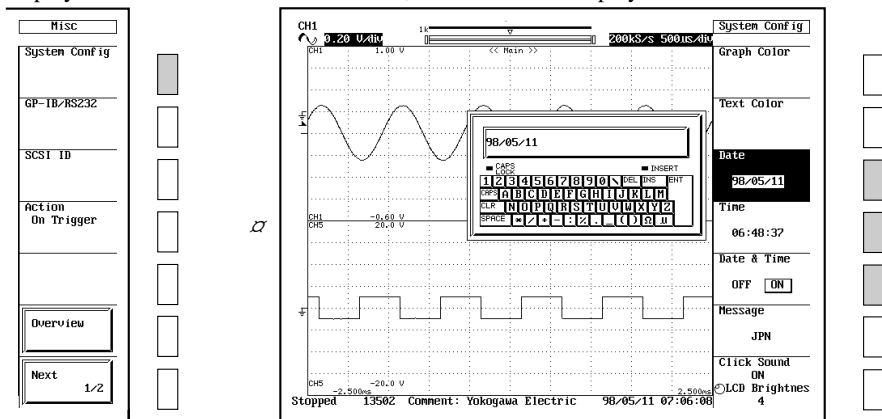

3.5 Installing the Input Module



WARNING

- To prevent electric shock and damage to the instrument, make sure to turn OFF the power before installing or removing the input module.
- Check that the input cable is not connected to the input terminals before installing or removing the input module.
- To prevent electric shock and to satisfy the specifications, make sure to put the accessory cover panel on the slots that are not being used.
Using the instrument without the cover panel allows the dust enter the instrument and may cause malfunction due to the rise in temperature inside the instrument.
- If the input module happens to come out of the slot while it is in use, it may cause electric shock or cause damage to the instrument as well as the input module. Make sure to screw the input module in place at the two locations (top and bottom).

Types of input modules*

Following 9 types are available.

- High-Speed Isolation Module (Model No. : 701855, Resolution of A/D converter : 12 bits)
- High-Speed Module (Model No. : 701856, Resolution of A/D converter : 12 bits)
- High-Resolution, High-Voltage, Isolation Module (Model No. : 701852)
- High-Resolution, Isolation Module (Model No. : 701853)
- Temperature Module (Model No. : 701860)
- Logic Input Module (Model No. : 701870)
- Strain Module (Model No. : 701880)
- High-Speed Isolation Module (Model No. : 701850, Resolution of A/D converter : 10 bits) (Discontinued)
- High-Speed Module (Model No. : 701851, Resolution of A/D converter : 10 bits) (Discontinued)

* The modules that can be used vary depending on the firmware version of the DL708E. See "Appendix 8" for details.

When installing or removing the input modules

- Switching the installed input module with a different module and turning ON the power initializes the setting values on that channel. To save the settings, specify the destination media and save the setting values (refer to Section 11.7 "Saving/Loading Set-up Data").
- When using only two or four channels to measure with a longer record length, install the modules in the following channels.

| No. of channel used | Channels to install |
|---------------------|---------------------|
| 2 | CH1, CH5 |
| 4 | CH1, CH3, CH5, CH7 |

Installation procedure

1. Make sure the POWER switch is OFF.
2. Check the channel number indicated above the slots for installing the input modules on the right side of the instrument. Then, install the module along the guide.
Holding the handles on the top and bottom of the input module, press hard until it clicks in place.
If there is a cover panel on the slot in which to install the module, remove the cover panel, first.
3. Make sure to screw the two locations, top and bottom, of the input module firmly into place.
4. Turn ON the power switch.
5. Check to see that the correct input module name is displayed at the corresponding channel number in the overview screen. If the display is not correct, remove the module according to the steps in "Removal" shown below, and reinstall the module according to steps 1 to 3 shown above. For details on the overview screen, refer to Section 14.4 "Checking the System Condition (Overview)."

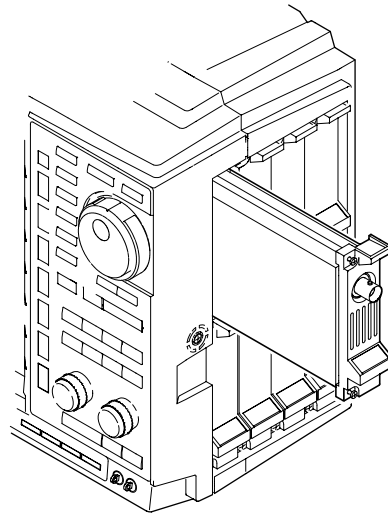

| System Overview | |
|-------------------------------|-----------------------|
| Model DL708E | Version: 4.00 JPN/ENG |
| Acquisition Men: 100kHz/CH | Max 400kHz |
| Math Length: 100kHz | Math User Def.: Yes C |
| Printer: Yes | External Clock: Yes |
| SCSI: Yes | HD: Yes (00050) I |
| Link Date: 98/05/28 Thu 15:48 | |
| Module Configuration | |
| 1: STRAIN(701880) | |
| 2: [None] | |
| 3: [None] | |
| 4: HR(701853) | |
| 5: [None] | |
| 6: LOGIC(701870) | |
| 7: [None] | |
| 8: LOGIC(701870) | |

| Input module | Abbreviation |
|---|--------------|
| High-Speed Isolation Module(701855) | HS_ISOL |
| High-Speed Module(701856) | HS |
| High-Resolution, High-Voltage, Isolation Module(701852) | HR_HV |
| High-Resolution, High-Voltage Module(701853) | HR |
| Temperature Module(701860) | TEMP |
| Logic Input Module(701870) | LOGIC |
| Strain Module(701880) | STRAIN |

Removal

1. Make sure the POWER switch is OFF.
2. Loosen the screws holding the input module in place.
3. Holding the handles on the top and bottom of the input module, pull out the module.

Note

See "Appendix 8" for compatibility between Input Modules and DL708E.

3.6 Connecting a Probe

(For High-Speed Isolation/High-Speed Modules)

Connecting a probe

Connect the probe (or other input cables such as the BNC cable) to any of the input terminals of the High-Speed Isolation/High-Speed Module.



WARNING

- When connecting the item to be measured, make sure to turn OFF the power on the item. Connecting or disconnecting the measurement input cable while the item being measured is turned ON is very dangerous.
- When making a voltage measurement on a common mode input voltage which is above 42 V (DC+ACpeak) with the High-Speed Isolation Module, make sure to use the dedicated probe, 700929.
- Applying a power above the value indicated below may cause damage to the input section. At a frequency above 1 kHz, damage may occur even when the voltage is lower than this voltage.

For High-Speed Isolation Module (701855)

Maximum input voltage (at a frequency of 1 kHz or less)

- Main instrument only (across the input terminals, H and L^{*1})
250 V (DC+ACpeak)(CAT I and II, 177 Vrms)
- Combined with 700929 (across the probe tips, H and L^{*3})
850 V (DC+ACpeak)(CAT I and II, 600 Vrms)

Maximum allowable common mode voltage (at a frequency of 1 kHz or less)

- Main instrument only (across the input terminal, L, and earth^{*2})
42 V (DC+ACpeak)(CAT I and II, 30 Vrms)
- Combined with 700929 (across the probe tip, H or L, and earth^{*4})
400 Vrms (CAT I and II)
(Specification when the EN61010-1 standard does not need to be satisfied: 600 Vrms)

For High-Speed Module (701856)

Maximum input voltage (across the input terminals, H and L^{*5}, at a frequency of 1 kHz or less)

250 V (DC+ACpeak)(CAT I and II, 177 Vrms)

Main instrument only

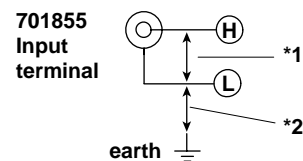

Combined with 700929

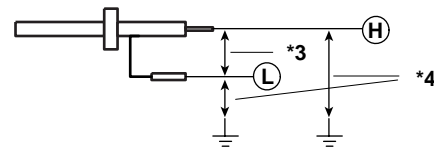

701856

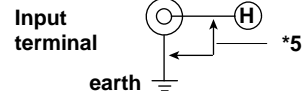

Points to Note when Connecting a Probe

- When connecting a probe to the instrument for the first time, perform phase correction of the probe as described in Section 3.10 “Compensating the Probe (Phase Correction)”. Failure to do so may result in unstable gain across different frequencies, thereby preventing correct measurement. Make the phase correction on each channel to which the probe is to be connected.
- If the object to be measured is connected to the instrument directly, without using a probe, correct measurement cannot be performed due to the input impedance.

Points to note when using a probe other than 700998 and 700929

- Correct measured values cannot be displayed if the probe’s attenuation ratio is not “1:1”, “10:1”, “100:1” or “1000:1”.

Setting the probe attenuation

Follow the operating procedure given in Section 5.6 “Selecting Probe Attenuation” (page 5-7) so that the probe’s attenuation matches the one displayed below “Probe” in the soft key menu. If they do not match, measured values cannot be read correctly.

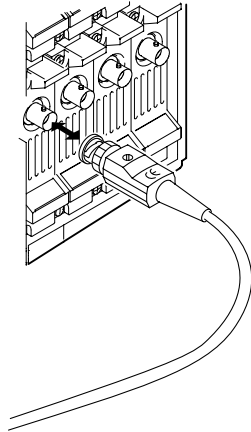

3.7 Connecting a Input Cable

(For High-Resolution, High Voltage, Isolation/High-Resolution, Isolation Modules)

Connecting a measurement cable

Connect the measurement cable to any of the input terminals of the High-Resolution, High-Voltage, Isolation/High-Resolution, Isolation Module.



WARNING

- When connecting the item to be measured, make sure to turn OFF the power on the item. Connecting or disconnecting the measurement cable while the item being measured is turned ON is very dangerous.
- To prevent electric shock, make sure to use the measurement cable suitable for the voltage range being measured on the input terminals of the High-Resolution, High-Voltage, Isolation/High-Resolution, Isolation Module.



CAUTION

- Applying a power above the value indicated below may cause damage to the input section. At a frequency above 1 kHz, damage may occur even when the voltage is lower than this voltage.

For High-Resolution, High-Voltage, Isolation Module (701852)

Maximum input voltage (across the input terminals, H and L*¹, at a frequency of 1 kHz or less)

850 V (DC+ACpeak)(CAT I and II, 600 Vrms)

Maximum allowable common mode voltage (across the input terminal, H or L, and earth*², at a frequency of 1 kHz or less)

400 Vrms (CAT I and II)

(Specification when the EN61010-1 standard does not need to be satisfied: 600 Vrms)

For High-Resolution, Isolation Module (701853)

Maximum input voltage (across the input terminals H and L*³, at a frequency of 1 kHz or less)

100 V (DC+ACpeak)(CAT I and II, 70 Vrms)

Maximum allowable common mode voltage (across the input terminal, H or L, and earth*⁴, at a frequency of 1 kHz or less)

400 Vrms (CAT I and II)

(Specification when the EN61010-1 standard does not need to be satisfied: 600 Vrms)

- Do not connect a plug-in type terminal with exposed conducting parts to the input terminal to be used as a measurement lead. It is very dangerous, if the connector happens to come off.

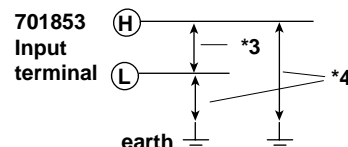
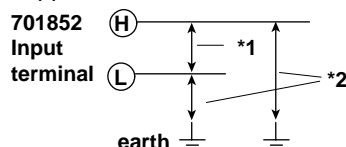

For measuring voltages of 42 V or less

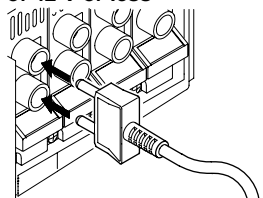

For measuring voltages of 42 V or more

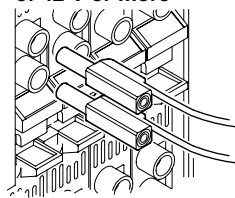

3.8 Connecting a Thermocouple

(For Temperature Module)

Connecting a thermocouple

Connect the thermocouple strand directly to the input terminals of the temperature module.



CAUTION

- The temperature module is insulated from the main instrument. However, if a voltage exceeding the value indicated below is applied, it may cause damage to the input section. At a frequency above 1 kHz, damage may occur even when the voltage is lower than this voltage.

Maximum input voltage (across the input terminals, H and L, at a frequency of 1 kHz or less)

42 V (DC+ACpeak)(CAT I and II, 30 Vrms)

Maximum allowable common mode voltage (across the input terminal, L, and earth, at a frequency of 1 kHz or less)

42 V (DC+ACpeak)(CAT I and II, 30 Vrms)

- If the + terminal and - terminal are reversed, correct measurement cannot be made.
- Immediately after connecting the thermocouple, the heat balance may be disturbed at the input terminal section and may cause measurement errors. Therefore, wait about ten minutes before making a measurement.
- In an environment where the air from the air conditioning is directly applied to the input terminals or where there are effects from a heat source, the heat balance may be disturbed at the input terminal section and cause measurement errors. When making measurements in these environments, take preventive measures such as changing the position.

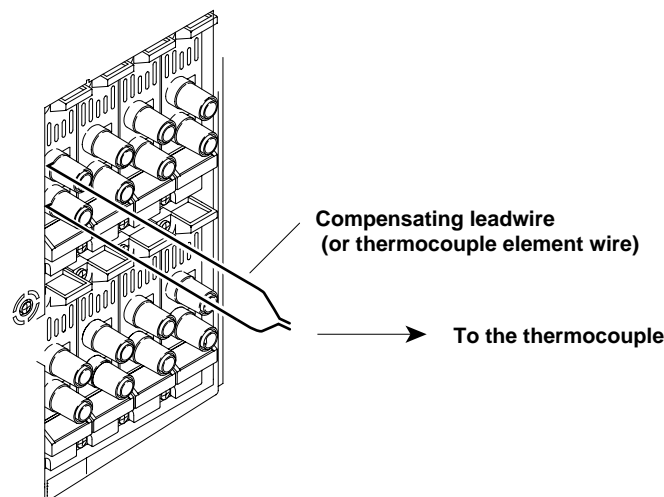

3.9 Connecting a Logic Probe

(For Logic Input Module)



CAUTION

- Applying a voltage exceeding the voltage indicated below may cause damage to the logic probe or the instrument. At a frequency above 1 kHz, damage may occur even when the voltage is lower than this voltage.
Maximum input voltage (at a frequency of 1 kHz or below)
High-speed logic probe (700986) 42 V (DC+ACpeak)
Isolation logic probe (700987) 250 Vrms (except ACpeak is 350 V or less, DC is 250 V or less)
- On the high-speed logic probe, the 8 input lines on each POD have a common earth. In addition, the earth for the instrument and the earth for each POD are also common. Do not connect inputs which have different common voltages, as doing so may cause damage to the main unit, logic probe, or other connected instruments.
- Each input terminal of the isolation logic probe is isolated from all other input terminals and the isolation logic probe is isolated from the DL708E.
- Make sure to turn off the instrument before connecting or disconnecting the 26-pin connector from the logic input connector.
- Do not stack the isolation logic probes during use. Also, allow enough space around the probes to avoid a temperature increase inside the probes.

Logic Input Connector

Connect the accessory logic probe (700986 or 700987) to either of the logic probe input connectors (the two connectors indicated POD A and POD B).

About the Logic probe

There are two types of probes available for connecting to the logic input connector of the DL708E.

- High-speed logic probe (700986)
- Isolation logic probe (700987)

Use the following leads to connect to the point of measurement.

The types of connecting leads that can be used on the high-speed logic probe (700986)

The following two types are available.

- Connecting lead (alligator clip, parts No. B9879PX)
This lead is mainly used for connecting contact circuits. The lead consists of 8 signal lines (red) and 8 earth lines (black).
- Connecting lead (IC clip, parts No. B9879KX)
This lead is mainly used for connecting electronic circuits. The lead consists of 8 signal lines (red) and 2 earth lines (black).

The types of connecting leads that can be used on the isolation logic probe (700987)

The following two types are available.

- For measuring voltages of 42 V or less : Measurement lead, Model 366961
- For measuring voltages of 42 V or more : Measurement lead, Model 758917

Do not alter the connecting leads. Doing so may cause the leads from satisfying the specification.

Connecting the Logic Probe

High-speed logic probe (700986)

1. Attach the accessory connecting lead (IC clip or alligator clip) to the logic probe, and lock the connector by clamping the lever inwards. To release the connecting lead from the logic probe, pull both levers outwards. Continue with step 3.

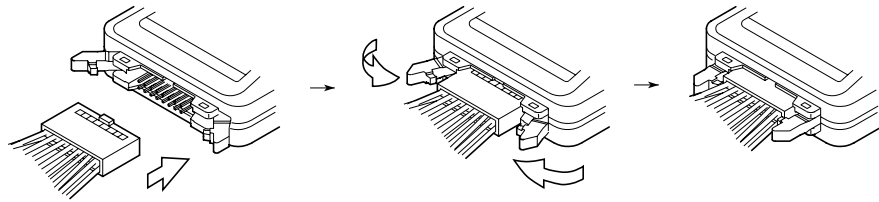

Isolation logic probe (700987)

1. Connect the measuring lead to the input terminal of the logic probe.
2. Set the input switch. The threshold level is set to 50 VAC \pm 50% (Hi : 80 to 250 VAC, Lo : 0 to 20 VAC) and 6 V \pm 50% (Hi : 10 to 250 VDC, Lo : 0 to 30 VDC) when set to "AC" and "DC," respectively.

Connecting the logic probe to the Logic Input Module

3. Turn OFF the instrument.
4. Connect the end with the 26-pin connector (clamp filter with ferrite core, parts No. A1190MN) of the logic probe to the input connector of the Logic Input Module.
5. Turn ON the instrument.

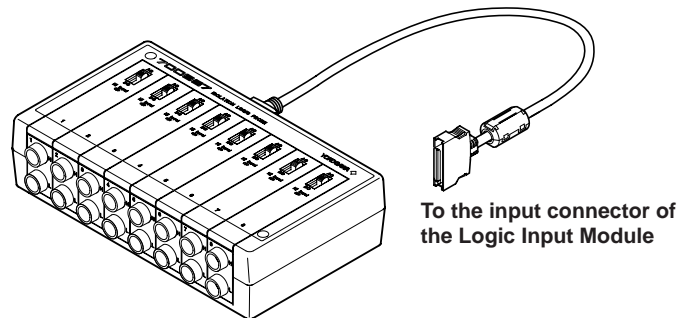

Note

- Each bit is displayed as "L level" when the logic probe is not connected to the instrument.
 - For the specifications of the logic probe, refer to Section 15.21 "Logic Input Module."
-

3.10 Compensating the Probe (Phase Correction)

When making measurements using the probe on the High-Speed Isolation Module or High-Speed Module, make sure to phase correct the probe, first.



CAUTION

Never apply an external voltage to the COMP terminal, as damage to the instrument may result.

Operating Procedure

1. Turn ON the power switch.
2. Connect the probe to the input terminal to which the signal is to be applied.
3. Touch the probe's tip against the COMP output terminal and connect the earth wire to the functional earth terminal.
4. Perform auto set-up using the procedure described on page 4-4.
5. Insert a screwdriver into the trimmer adjusting hole in the probe and turn the trimmer so that the displayed waveform becomes square.

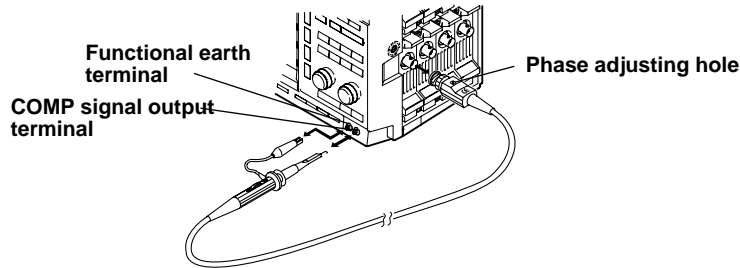

Explanation

Reason for probe compensation

If the probe's input capacitance is outside the specified range, the gain will not be constant across different frequencies, preventing display of the correct waveforms. The input capacitance varies depending on the probe used, so the variable capacitor (trimmer) provided on the probe must be adjusted.

Probe compensation must be performed when the probe is to be used for the first time.

Moreover, the appropriate input capacitance varies according to which channel is used, so probe compensation is required when the probe is switched from one channel to another.

Compensation signal

A COMP signal (square waveform) of the following characteristics is output from the COMP terminal on the front panel.

Frequency : 1 kHz \pm 10%

Amplitude : 1 V \pm 10%

Waveform differences

Correct waveform

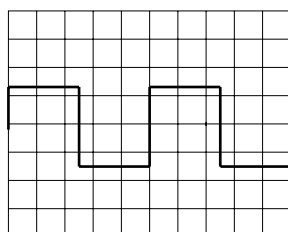

Over-compensated
(gain is too high at high frequency)

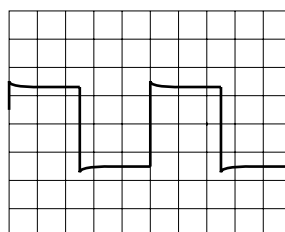

Under-compensated
(gain is too low at high frequency)

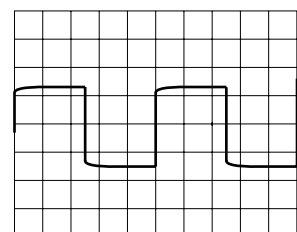

3.11 Connecting the Bridge Head

(For Strain Module)

Connect a strain gauge bridge (bridge head) or strain gauge transducer and measure the strain. This section describes the procedures for connecting YOKOGAWA's bridge head (700932/700933) and precautions regarding the connection. For details on connecting other strain gauge bridges and strain gauge transducers, see the corresponding manuals.



CAUTION

Do not connect any other devices other than strain gauge bridge and strain gauge transducer to the strain module. Connecting other devices or applying voltages exceeding the value shown below can damage the input section.

Maximum input voltage (across terminals)

5 V (DC+AC_{peak})

Maximum allowable common mode voltage (across each terminal and earth)

42 V (DC+AC_{peak}) (CAT I and II, 30 V_{rms})

Connecting the Strain Gauge

Bridge head 700932/700933 supports six types of connecting methods: single-gauge method, single-gauge three-wire method, adjacent-side two-gauge method, opposed-side two-gauge method, opposed-side two-gauge three-wire method, and four-gauge method. For details, see the manual, IM700932-01E that came with bridge head 700932/700933. If you are using a strain gauge bridge other than 700932/700933 or a strain gauge transducer, then see the corresponding manuals.

Connecting the Strain Module and the Bridge Head

When using bridge head 700932/700933

Connect the strain module and the bridge head using the cable that is included with 700932/700933.

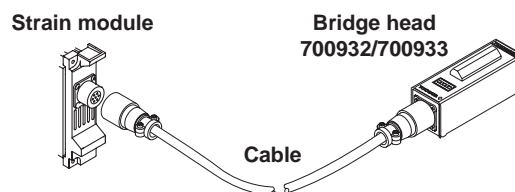

When using a bridge head with MIL Standard connector wiring

The connector for the strain module is a NDIS connector*. Convert MIL to NDIS using YOKOGAWA's connector conversion cable 700940, then connect to the strain module.

* A connector recommended by JSNDI (The Japanese Society for Non-destructive Inspection).

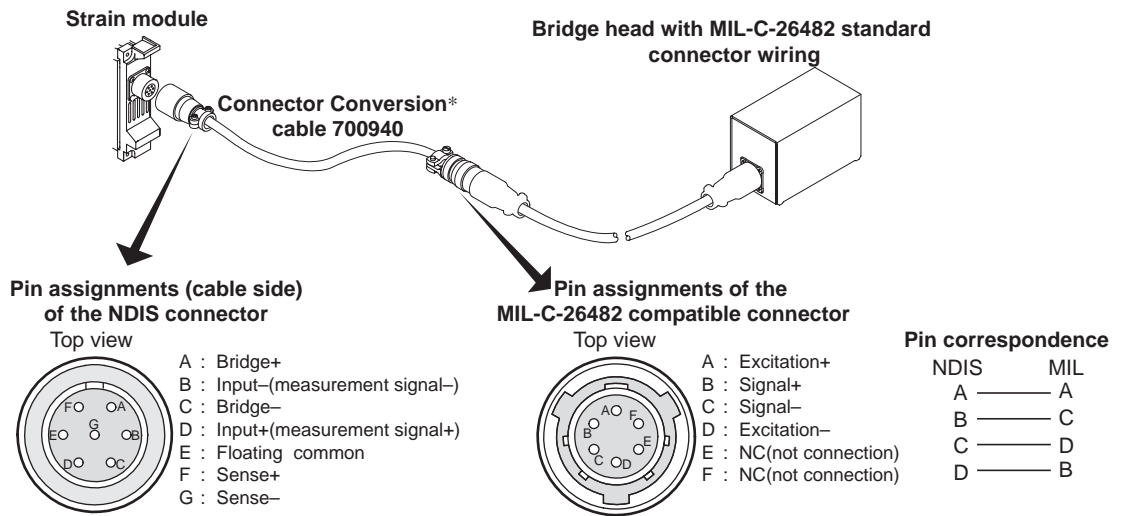

* There are two types of NDIS-MIL conversion cables. They are different in the pin numbers on the MIL side. Please be careful, because the connector shape is the same for both types. They can be distinguished as follows.

How to distinguish the conversion cables

700940 : The model name "700940" is written on the cable.

700935 : No model name is written on the cable.

The 700935 were shipped initially, but it is no longer in production. If you have the 700935, contact the dealer from which you purchased it.

When using YOKOGAWA's A1002JC connector

You can make a cable using the A1002JC connector that matches the connector of the strain module and use the cable to connect strain gauge bridges and strain gauge transducers to the strain module.

NDIS connector A1002JC

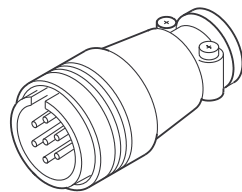

Pin assignments

Top view

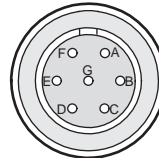

- A : Bridge+
- B : Input-(measurement signal-)
- C : Bridge-
- D : Input+(measurement signal+)
- E : Floating common
- F : Sense+
- G : Sense-

Note

To avoid external noise, we recommend that you use shielded wires when making cables.

CAUTION

Be careful when wiring the connector. If there is a short or an error in the wiring, it can damage the main instrument or other devices connected to the main instrument.

4.1 Entering Values and Character Strings

Entering a Value

Direct entry using the special knob

The following knobs can be used to enter values directly irrespective of the currently displayed menu.

V/DIV and **TIME/DIV** knobs

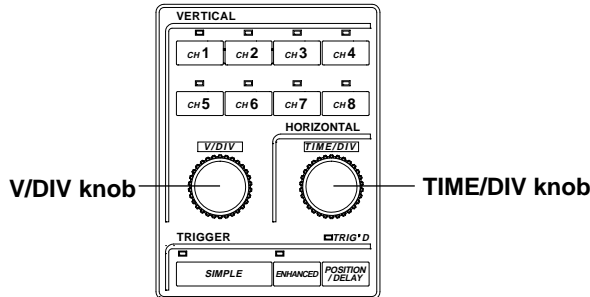

Note

Before turning the **V/DIV** knob, the channel for which you are going to use the knob must be selected using one of the keys **CH1** to **CH8**.

V/DIV knob is applicable only to channels which have the voltage module (701855, 701856, 701852, 701853, 701850, and 701851) installed.

Entry using the jog shuttle

Before using the jog shuttle to enter a value, you must select the desired parameter by pressing the corresponding soft key. The shuttle ring (the outer ring of the shuttle) allows you to enter values in larger steps than the jog dial. The size of the step depends on the angle by which the shuttle ring is turned. For some parameters you can use the arrow keys below the jog shuttle to shift from one digit to the next.

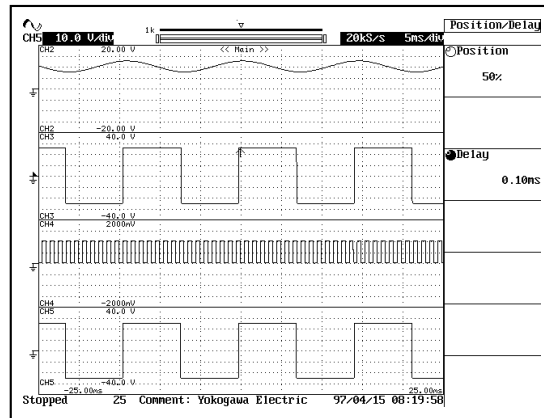

Note

If you make an incorrect change with the jog shuttle, you can undo the change by pressing the **RESET** key.

Entering a Character String

Date/time, file name and comment can be entered using the keyboard displayed on the screen. Operate the keyboard using the jog shuttle, **SELECT** key and arrow key to enter a character string as follows.

Entry using the keyboard

1. Turn the jog shuttle to move the cursor to the character to be entered.
If a character string such as the date and time has already been entered, move the cursor to the position in the string at which you want to enter a character.
2. Press the **SELECT** key to enter the character.
3. Repeat steps 1 and 2 to enter all the characters in the string.
4. Enter "ENT" to enter the string.

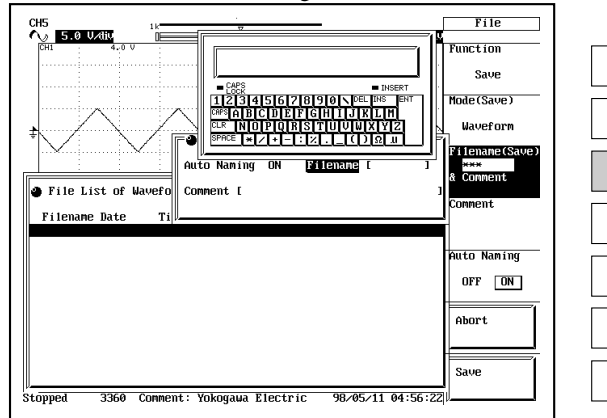

Keys other than characters

- DEL : Deletes the character at the cursor location.
- INS : Switches between insert and overwrite modes. The indicator will be lit during insert mode.
- CLR : Deletes all displayed characters.
- SPACE : Enters a space.
- ENT : Confirms the displayed characters.

Number of characters and types available

| | Number of characters | Available characters |
|------------|----------------------|----------------------------------|
| Date, time | Specified number | 0 to 9 (/:) |
| File name | 1 to 8 | 0 to 9, A to Z, %, _, (,) |
| Comment | 0 to 30 | All characters (including space) |

* The maximum length of the comment when saving waveform data or set-up data is 20 characters.

Note

- Comments and file names can both contain both upper and lower case letters. However, file names are NOT case sensitive. The following five file names are not allowed due to MS-DOS restrictions.
AUX, CON, PRN, NUL and CLOCK
- When using GP-IB/RS-232 interface commands to enter a file name, the following symbols which are not available on the keyboard displayed on the screen can also be used.
!, #, \$, &, ', -, ^, @, ~, { }

4.2 Initializing Settings

Function

The initialization function allows you to reset parameter values which have been set using panel keys to the default (factory settings). This is very convenient when you have to cancel the previous settings or when you have to restart measurement from the beginning.

Initialization

Initialization means resetting parameters to their factory setting values. For details on factory settings, refer to the Appendix 5.

Settings which cannot be initialized

Date and time
GP-IB/RS-232 interface related settings
SCSI ID number

To cancel initialization

If you have performed initialization by mistake, press the “**Undo**” soft key. This will restore the previous settings used before the initialization was performed.

The “**Undo**” operation remains available only while power stays on.

Initialization at power ON

Turning the power switch ON while holding down the **RESET** key will start initialization. This also initializes settings relating to the GP-IB/RS-232 interface and SCSI ID number.

Operating Procedure

Performing initialization

1. Press the **SETUP** key.
2. Press the “**Initialize**” soft key to start initialization.

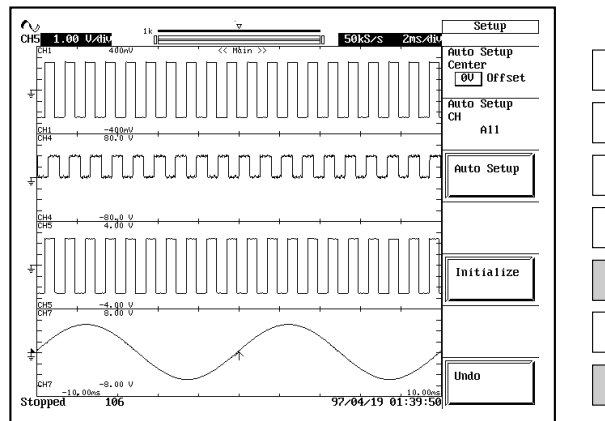

Canceling initialization

3. Press the “**Undo**” soft key. This will restore the previous settings that were in effect before initialization.

4.3 The Auto Set-up Function

Function

The auto set-up function automatically sets each key setting, such as the V/div, T/div and trigger level, to the optimum value for the input signal.

Center position after auto set-up

0V : Sets the center position to “0 V”. Convenient when you want to see the relation between the ground level and the waveform.

offset : Sets the center position to the offset value. Convenient when you want to see the waveform with maximum amplitude.

An example of auto set-up: The following screens show the square waveform with an offset of 1 V and an amplitude of 500 mVp-p after auto set-up.

Auto set-up (0 V)

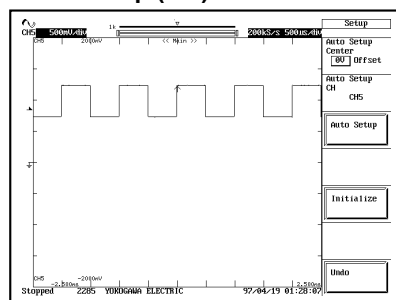

Auto set-up (offset)

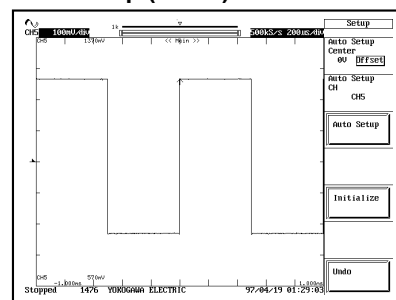

Setting channel(s)

CH1 to CH8 : Auto set-up is performed only for the selected channel. Select the channel using one of the keys CH1 to CH8. However, if auto set-up is performed on a channel which has a temperature module or a logic input module installed, an error message is displayed.

ALL : Auto set-up is performed for all channels. However, channels which have temperature modules or logic input modules installed are excluded from the auto set-up.

Canceling auto set-up

To cancel auto set-up, just press the “**Undo**” soft key. This will restore the previous state which was in effect before the auto set-up.

Waveforms for which auto set-up is effective

Frequency : Approx. 50 Hz to 100 kHz

Amplitude : Approx. 100 mVp-p or higher when the probe attenuation is 10:1.

Type : Repetitive (but not complex) waveform
Where input coupling is DC.

Note

The auto set-up function may not operate correctly in certain cases such as when the waveform contains DC components or high frequency components.

Settings made by auto set-up**Waveform acquisition and display**

| | |
|-------------------|--|
| Acquisition mode | Normal |
| Acquisition count | Infinite |
| Record length | 1 kword |
| Accumulation mode | OFF |
| Zoomed waveforms | Traces set ON for display (realtime OFF) |

Vertical-axis settings

| | |
|-------------------|---|
| V/div | Set so that amplitude is between 2 divp-p and 7 divp-p (approximately) |
| Offset voltage | At Center 0 V : 0 V At Center Offset : Center value of the maximum and minimum values of the input signal |
| Vertical position | 0div |
| Coupling | DC |
| Inverse display | OFF |
| Display ON/OFF | If "All" channels are selected, only channels with active input signals are set ON for display. If a single channel is selected, only that channel is set ON for display. |

Horizontal-axis settings

| | |
|-----------|--|
| T/div | Set so that screen displays 2 to 4 periods of the auto-setup waveform with the longest period. |
| Time Base | Set the time base to "Int." |

Trigger settings

| | |
|-------------------------|---|
| Trigger type | SIMPLE |
| Trigger source | The auto-setup channel with the longest period (if "All" channels are selected), or the target channel (if a single channel is selected). |
| Trigger level and slope | Level is 1/2 the trigger source amplitude. Slope is "rising." |
| Trigger coupling | DC |
| Hysteresis | ∇ (High sensitivity) |
| Holdoff time | 0ns |
| Trigger position | 50% |
| Trigger delay | 0s |

Automatic setup affects only the settings listed above. All other settings remain unchanged.

Note

- Auto-setup is not applied to channels whose input signals do not meet the required setup conditions. Following auto-setup, display for these channels will be set OFF (even if an input signal is present.)
- If auto-setup cannot execute on all channels, the trigger source is set to CH1.

Operating Procedure**Selecting the center position and channel and performing auto set-up**

1. Press the **SETUP** key. The set up menu will appear.
2. Press the "Auto Setup Center" soft key to select "0V" or "Offset".
3. Press the "Auto Setup" soft key to display the channel selection menu.
4. Keep pressing the "Target CH" soft key until the desired channel (ALL, or CH1-CH8) is selected.
"CH1" to "CH8" can be directly selected by pressing **CH1** to **CH8**.
5. Press the "Auto Setup" soft key to start auto set-up.

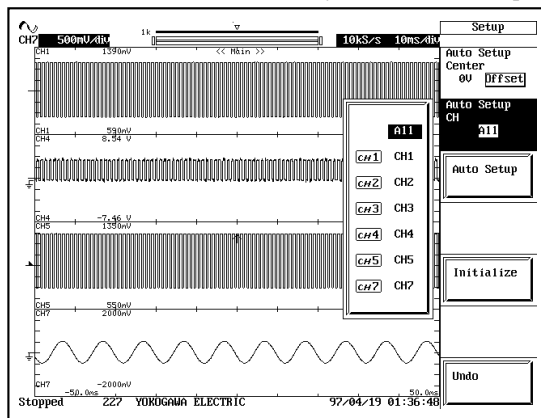
**Canceling auto set-up**

6. Press the "Undo" soft key. This will restore the previous state which was in effect before the auto set-up.

4.4 Starting and Stopping Acquisition

Function

The following three methods are available for starting and stopping acquisition.

Using the **START/STOP** key : The data are continuously acquired and displayed according to the trigger mode setting (see section 6.1).

Using the “**Single Start**” soft key (ACQ menu) : Pressing the soft key sets the trigger mode to normal mode. When a trigger is activated the specified record length of data is acquired once and the waveform is displayed.

Using the “**Log Start**” soft key (ACQ menu) : Pressing the soft key disables the trigger mode. The specified record length of data is acquired once and the waveform is displayed.

When the display is in roll mode, the “**Single Start**” or “**Log Start**” operation is as follows.

- By pressing the “**Single Start**” soft key, the trigger mode is set to normal mode. After acquiring the specified record length of data following a trigger activation, the displayed waveform stops.
 - By pressing the “**Log Start**” soft key, the trigger mode is disabled. After acquiring the specified record length of data, the displayed waveform stops.
- * The change in the trigger mode due to pressing the “**Single Start**” and “**Log Start**” soft keys does not affect the trigger mode setting of section 6.1.

Starting and stopping during averaging or sequential store mode

Stopping acquisition will also stop data processing.

Re-starting acquisition will start data processing from the scratch.

Starting and stopping while accumulation is in progress

Stopping acquisition will stop accumulation temporarily. Re-starting acquisition will resume accumulation from the point at which acquisition was stopped.

The START/STOP key and “Single Start,” “Log Start” soft keys are not operative in the following cases.

The instrument is in remote state, controlled via the communication interface.

The instrument is in operation, for example, it is in the process of printing out or performing auto set-up.

Setting the waveform acquisition mode at power ON

You can select whether or not to start waveform acquisition when the power turns ON.

For example, you can set this mode to ON if you want to start waveform acquisition when the power turns ON after a power failure.

ON : Start waveform acquisition when the power turns ON.

OFF : Do not start waveform acquisition when the power turns ON.

Initial setting is OFF.

Note

- Pressing certain keys (such as the **FILE** or **HISTORY** key) or changing the “Realtime Out” soft key setting causes acquisition to stop immediately.
- If you change the acquisition conditions, all data already in acquisition memory is lost when acquisition resumes.
- The snapshot function, which retains the waveforms currently displayed on the screen, is also available. This function allows update of the display without stopping acquisition. (Refer to page 4-8.)

Operating Procedure

Using the **START/STOP** key

Acquisition starts and stops alternately each time the **START/STOP** key is pressed. If the indicator on the **START/STOP** key is lit, acquisition is in progress.

Using the “Single Start,” “Log Start” soft keys

- 1. Press the **ACQ** key.
- 2. If the “Single Start” soft key is pressed and the trigger is activated, the waveform is acquired once.

When the “Log Start” soft key is pressed the waveform is acquired once.

When acquisition is complete, acquisition stops automatically (the indicator above the **START/STOP** key turns off).

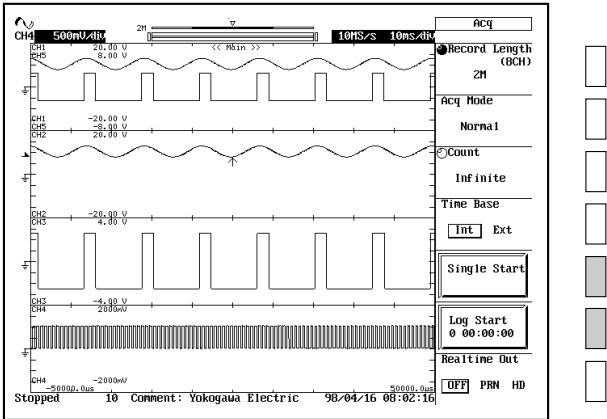

Setting the waveform acquisition mode at power ON

- 1. Press the **MISC** key.
- 2. Press the “Next” soft key to display the “Next2/2” menu. Then, press the “Others” soft key.
- 3. Press the “Start Mode (Power ON)” soft key and select “ON” or “OFF.”

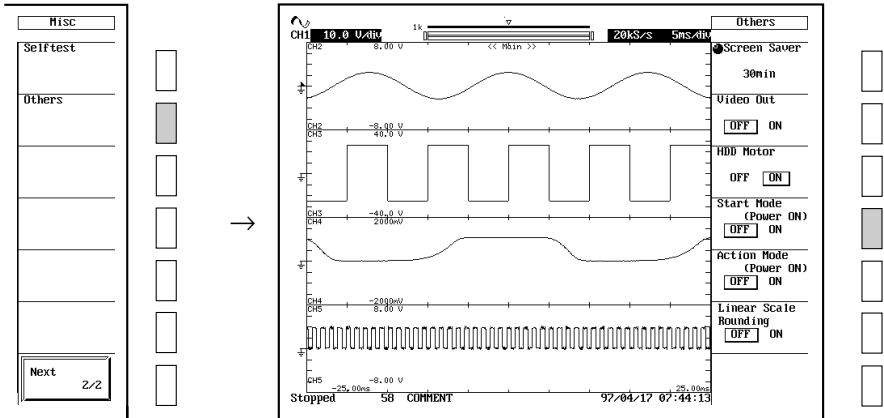

4.5 The Snapshot and Clear Trace Functions

≡ For a description of this function, refer to page 1-22. ≡

Function

Snapshot

This function retains the waveforms currently displayed on the screen. It also enables update of the display without stopping acquisition. Hence it is very useful when you want to compare waveforms.

The following operations are not available for snapshot waveforms.

- Cursor measurements and automatic measurements
- Zoom and math operations
- Output to external plotter or other location
- Move the vertical position of the waveform
- Set the offset voltage
- Save the waveform data
- Display the X-Y waveform

Clear trace

This function clears every waveform currently displayed on the screen.

If the trace is cleared while waveform acquisition is in progress, it is restarted from the first trace.

The *SNAP SHOT* key and *CLEAR TRACE* key are not operative in the following cases.

- The instrument is in remote state, controlled via the GP-IB interface.
- The instrument is in operation, for example, it is in the process of printing out or performing auto set-up.

Operating Procedure

Snapshot

Press the ***SNAP SHOT*** key. The snap shot process will start.

Clear trace

Press the ***CLEAR*** key. The clear trace process will start.

Averaging and measurement will also be started from the scratch. (The count is reset to "0".)

4.6 Calibration

Function

Calibration

The following parameters can be calibrated. Perform calibration when highly accurate measurements are required.

Ground level offset
A/D converter gain

Points for attention

- Always allow the instrument to warm up for at least 30 minutes after the power is turned ON before starting calibration. If calibration is performed immediately after the power is turned ON, the calibration may be inaccurate due to drift caused by fluctuation in the temperature of the instrument.
- Calibration must be performed when the temperature of the instrument is stable and is between 5°C and 40°C (preferably at 23°C \pm 2°C).

Note

The above calibration is performed automatically when power is turned ON or when the V/DIV knob is turned.

Auto calibration

If “AutoCal” is set to “ON”, auto calibration is performed after the time shown below passes and the first time the time axis setting (T/div) is changed.

After turning ON the power

- 3 minutes pass
- 10 minutes pass
- every 30 minutes from here on after

Operating Procedure

Performing calibration

1. Press the **SHIFT+SETUP** key. The Calibration menu will appear.
2. Press the “**Calibration**” soft key to start calibration.

Auto calibration

2. Press the “**AutoCal**” soft key to select “ON.”

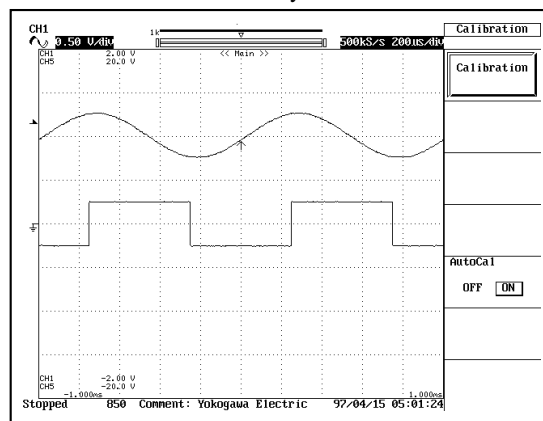

4.7 Using the Help Function

Function

Displaying a help window

Pressing the **HELP** key displays the soft key menu which was in effect before the **HELP** key was pressed, or displays a help window which contains information related to jog shuttle menu settings.

If a key is pressed or the jog shuttle is turned while a help window is displayed, the help window relating to the displayed soft key menu or the jog shuttle menu will appear.

For the **COPY** key only, pressing the key actually carries out the copy.

Clearing the help window

Pressing the **HELP** key again while a help window is displayed will clear the help window.

Operating Procedure

1. Press the **HELP** key.
2. Press the function key or soft key for which you want help.

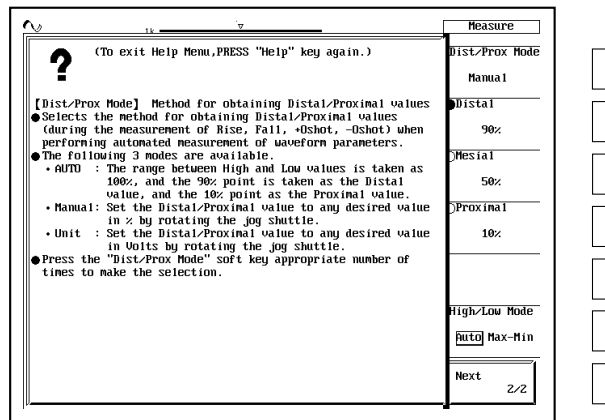

Clearing the help window

3. Press the **HELP** key again to close the window.

4.8 Selecting the Time Base

Function

Selecting the time base

Select the time base from the following choices.

Int : Internal clock signal (TIME/DIV knob is effective)

Ext : Clock signal input through the external clock input terminal (TIME/DIV knob is ineffective)

When selecting “EXT”

Apply a clock signal to the terminal that is indicated as “TRIG OUT/EXT CLK IN” (used also for trigger output) on the left side of the instrument. Follow the specifications shown below.



| | |
|---------------------|--|
| Connector type | RCA jack (AUDIO jack) |
| Frequency range | 100 kHz or less |
| Input level | CMOS level |
| Minimum pulse width | 1 μ for High and Low |
| Applicable module | High-Resolution, High-Voltage, Isolation Module (701852) High-Resolution, Isolation Module (701853) Temperature Module (701860) Logic Input Module (701870) Strain Module (701880) |
| Inapplicable module | High-Speed Isolation Module (701855) High-Speed Module (701856) High-Speed Isolation Module (701850) High-Speed Module (701851) |

Circuit diagram of the external clock input/timing chart

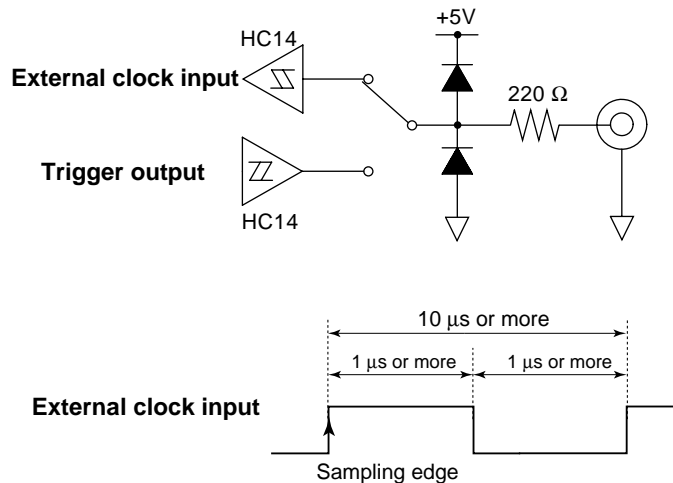

CAUTION

Applying a voltage outside 0 to 5 V range to the “TRIG OUT/EXT CLK IN” terminal can damage the input section.

Precautions when sampling with an external clock signal

- Clock signal must be set to continuous signal. You cannot use a burst signal.
- You cannot set the acquisition mode to envelope mode or box average.
- You cannot display the waveform in roll mode.
- There is no function to divide the frequency of the clock signal.
- Since you cannot change the time axis setting, change the record length setting or zoom in/out on the time axis to change the display range of the time axis.
- The time measured by using cursor measurements and automatic measurement of waveform parameters are in terms of clock counts of the clock signal. The unit is not displayed.
- You cannot select realtime print or realtime record to the internal hard disk.
- The following limitations exist for the trigger function.
 Trigger delay setting becomes invalid.
 Holdoff setting becomes invalid.
 You cannot select B>Time, B<Time, and B Time Out triggers.

Operating Procedure

1. Press the **ACQ** key.
2. Press the **“Clock”** soft key and then select **“Int”** or **“Ext.”**

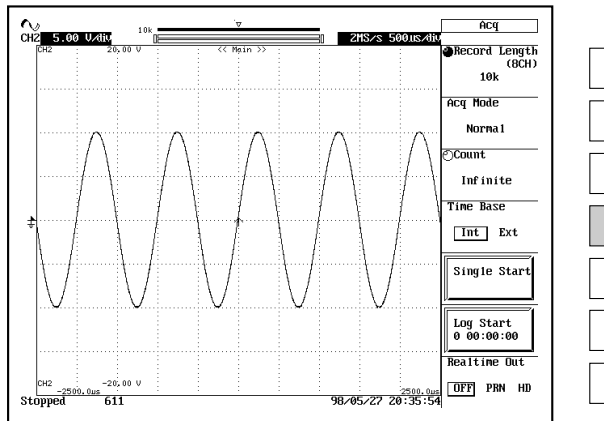

5.1 Turning Channels ON/OFF

Function

The channels CH1 to CH8 can be displayed simultaneously.
For channels which have their display is turned ON, the LED above the key lights.
However, channels which do not have input modules installed cannot be turned ON.

Note

- The screen can be split into up to eight display areas. (Refer to page 8-1.) A scaling value and waveform label name for each display area (refer to page 8-8, 8-9) can also be displayed.
- If a waveform or waveforms are loaded from history memory or floppy disk, the input waveform cannot be displayed. To compare waveforms, use the snapshot function.

Operating Procedure

1. Press one of the **CH1** to **CH8** keys to select the desired channel.
2. Press the “**Display**” soft key to select “**ON**” or “**OFF**”.

The display can be turned ON/OFF directly by pressing **CH1** to **CH8** several times.

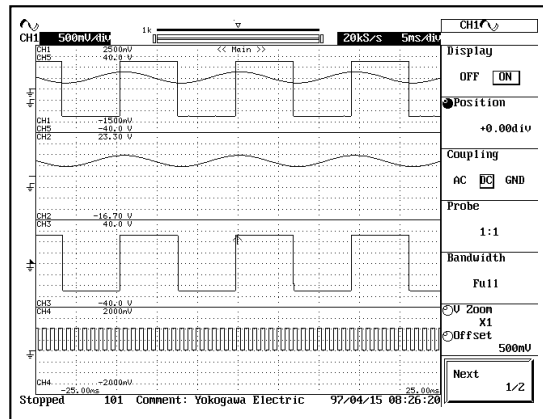

Note

The ON/OFF of the display of each channel can be set using the jog shuttle and the **SELECT** key when the power is turned ON; immediately after performing initialization or auto set-up; when the saved data is loaded; or at the screen displayed after continuously pressing the **ESC** key (all channel setting menu). Refer to page 5-15.

5.2 Setting T/div

≡ For a description of this function, refer to page 1-2. ≡

Function

The T/div setting is made by setting the time per division on the screen grid.

T/div setting range

Different types of modules can be installed simultaneously in this instrument. The available T/div range is as follows.

500 ns/div to 100 ks/div (1-2-5 steps)

However, some T/div settings can not be selected depending on the record length. For details, refer to Appendix 1 “Relationship between the Time Axis Setting, Sample Rate and Record Length.”

Maximum sample rate

The maximum sample rate varies according to the input module as follows.

| Input module | Maximum sample rate |
|---|---------------------|
| High speed isolation module | 10 MS/s |
| High speed module | 10 MS/s |
| High resolution high voltage isolation module | 100 kS/s |
| High resolution isolation module | 100 kS/s |
| Temperature module | *1 |
| Logic input module | *2 |

*1 Data update rate is approximately 135 Hz.

*2 The response time varies according to the logic probe being used. For details, refer to Section 15.21.

T/div display

If the T/DIV knob is turned while the waveform acquisition is stopped, the top section displays the T/div corresponding to the display waveform and the bottom section displays the changed T/div. The changed T/div value becomes valid on the next start.

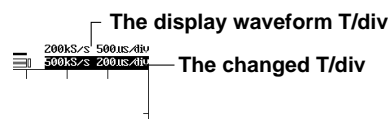

T/div and roll mode

The display switches to roll mode if the trigger mode is auto or auto-level; T/DIV is between 100 ms/div and 100 ks/div; and the sample rate is 100 kS/s or less. However, when using “Log Start” or “Single Start”^{*} under the ACQ menu, the display is in roll mode even when the trigger mode is set to normal.

^{*} If the firmware version of the DL708E is 4.00 or later, waveforms are displayed in roll mode when the “Single Start” soft key is pressed.

Notes on the roll mode display

- Up to the first three points of data become undefined on the waveform display immediately after the start of the roll mode.
The number of points that become undefined depends on the sample rate.
Make sure that the measurement range does not include these three points such as in the automatic measurement of waveform parameters.
- The operations when selecting “Single Start”/“Log Start” from the ACQ menu are as follows.
By pressing the “Single Start” soft key, the trigger mode is set to normal mode. After acquiring the specified record length of data following a trigger activation, the displayed waveform stops.
By pressing the “Log Start” soft key, the trigger mode is disabled. After acquiring the specified record length of data, the displayed waveform stops.
- Changing the V/div, T/div, or trigger setting resets the roll mode display.
- Computation, cursor measurements, and automatic measurement of waveform parameters can not be made.
- X-Y waveform displays the data after performing P-P compression.
X-Y waveform is displayed in the range from –5 div to 5 div, not in the range specified by “Start Point/End Point” (see page 8-10). However, if you stop the waveform acquisition, the waveform is displayed in the range specified by “Start Point/End Point.”
- Averaging and sequential store are not possible.
- Action on trigger is not possible.

Display example

When sampling a 10 kHz input signal at 5 MS/s

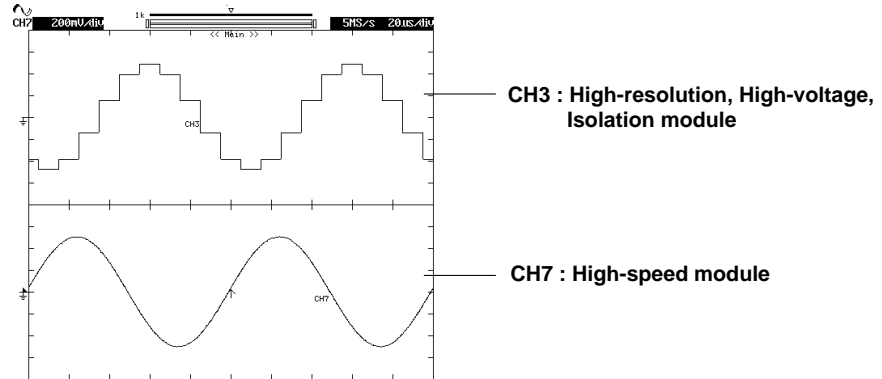
**Operating Procedure**Turn the **TIME/DIV** knob to set the desired T/div.

5.3 Setting V/div

(For High-Speed Isolation/High-Speed/High-Resolution, High-Voltage, Isolation/High-Resolution, Isolation Modules) ≡ For a description of this function, refer to page 1-3. ≡

Function

The V/div (voltage axis sensitivity) setting is used to adjust the amplitude of the displayed waveform so that the waveform can be observed easily. The V/div setting is made by setting the voltage value per division on the screen grid. Setting is in 1-2-5 steps (1V/div → 2V/div → 5V/div).

V/div setting range

The setting range varies depending on the input module as shown below.

| Input module | Setting range |
|---|----------------------|
| High-Speed Isolation Module (701855) | 5mV/div to 20V/div |
| High-Speed Module (701856) | 5mV/div to 20V/div |
| High-Resolution, High-Voltage, Isolation Module | 50mV/div to 200V/div |
| High-Resolution, Isolation Module | 5mV/div to 20V/div |

* The above values are given for a probe attenuation of 1:1. They will be 10 times the value shown when it is 10:1, 100 times the value shown when it is 100:1, and 1000 times the value shown when it is 1000:1.

V/div display

If the V/DIV knob is turned while the waveform acquisition is stopped, the top section displays the V/div corresponding to the displayed waveform and the bottom section displays the changed V/div. The changed V/div value becomes valid on the next start.

 The displayed waveform (CH1) V/div
The changed V/div

Operating Procedure

1. Press one of the keys **CH1** to **CH8** to select the desired channel.
2. Turn the **V/DIV** knob to set the desired value.

Note

- Rotating the **V/DIV** knob while acquisition is suspended has no effect on cursor and automatic measurements, which continue to reflect the original V/div scale until acquisition is resumed.
- Certain screens allow you to use the jog or shuttle dial and **SELECT** key to select the channel(s) for V/div setting. This feature is available (a) immediately after power ON, (b) immediately after initialization or automatic setup, and (c) when you are reloading saved data. You can also produce one of these screens by pressing the **ESC** key one or more times. Refer to page 5-14.
- The upper section of the V/div display (upper left of the screen) when zooming in the vertical direction with “V Zoom,” is the V/div corresponding to the displayed waveform (V/div that is zoomed with “V Zoom”). The lower section is the value being set with the V/div knob (V/div before zooming with “V Zoom”).

5.4 Setting the Vertical Position of a Waveform

(For High-Speed Isolation/High-Speed/High-Resolution, High-Voltage, Isolation/High-Resolution, Isolation/Logic Input Modules)

≡ For a description of this function, refer to page 1-4. ≡

Function

Range of movement

The vertical position can be moved in the range between ± 4 div from the center position in the waveform display frame.

Setting resolution

0.01 div

Waveforms that can not be moved

Snap shot waveforms

Confirming the vertical position

For input waveforms and computed waveforms, the ground level and vertical position are marked on the left of the waveform display frame.

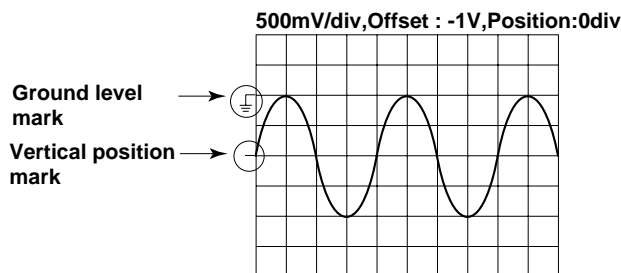

Note

- The data which go out of the waveform display frame from moving the vertical position are handled as overflow data.
- If the display waveform goes out of the waveform display frame from moving the vertical position during the waveform acquisition is starting, a chopped waveform is displayed as shown in the following figure even if the vertical position is returned to its original position after stopping the acquisition.

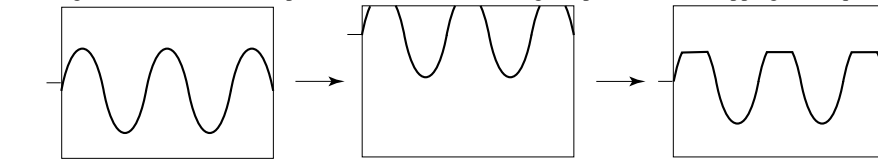

Operating Procedure

1. Press one of the keys **CH1** to **CH8** to select the desired channel.
2. Press the “**Position**” soft key to set the jog shuttle action to “**Position**”.
3. Turn the jog shuttle to set the vertical position.

You can change the setting a digit using the arrow keys (located below the jog shuttle).

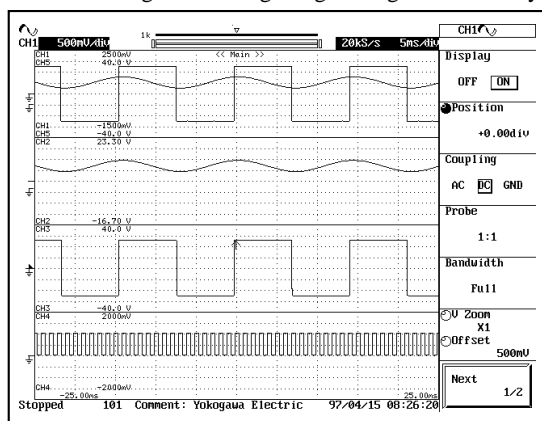

5.5 Selecting Input Coupling

(For High-Speed Isolation/High-Speed/High-Resolution, High-Voltage, Isolation/High-Resolution, Isolation Modules) ≡ For a description of this function, refer to page 1-4. ≡

Function

Input coupling

The following three types of input coupling are available.

AC : Acquires and displays only the AC content of the input signal.

DC : Acquires and displays both the DC and the AC content of the input signal.

GND : Checks the ground level.

Input coupling and frequency characteristic

The frequency characteristic when “AC” or “DC” is selected is shown below.

Note that low-frequency signals and low-frequency contents are not acquired if “AC” is selected.

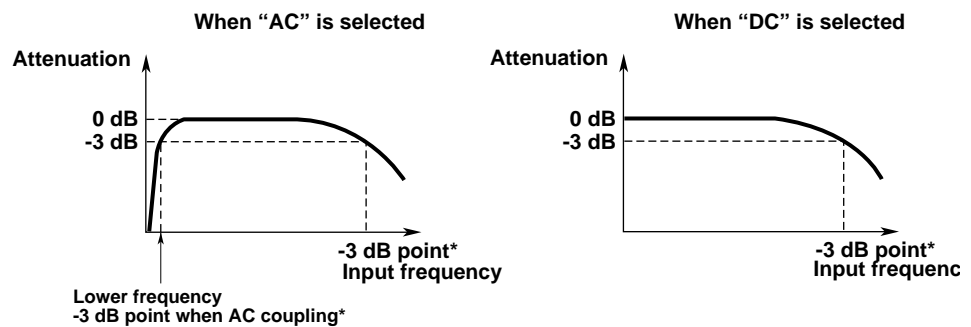

* The value varies for each input module. For details, refer to Section 15.16 to 15.19.



CAUTION

- When the input coupling is set to “AC” and the frequency of the input signal is less than 1 Hz, the input terminal of the instrument does not attenuate the signal to 1/10 even if a probe with attenuation ratio of 10:1 and input resistance of 10 MΩ is used. Therefore, make sure not to input a voltage that has a signal component less than 1 Hz that exceeds the maximum input voltage of each module.
- Do not apply voltages exceeding the maximum input voltage or the maximum allowable common mode voltage of each of the input modules. It may damage the input section.

Operating Procedure

1. Press one of the **CH1** to **CH8** keys to select the desired channel.
2. Press the “Coupling” soft key to select “DC”, “AC” or “GND”.

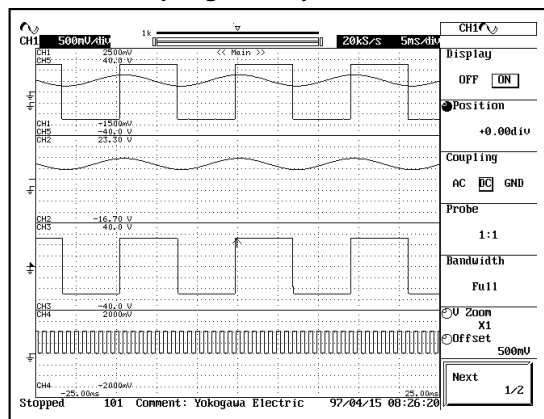

5.6 Selecting Probe Attenuation

≡ For a description of this function, refer to page 1-4. ≡

For High-Speed Isolation/High-Speed Module, set the attenuation according to the probe being used. For High-Resolution, High-Voltage, Isolation/High-Resolution, Isolation Module, set the attenuation to 1:1.

Function

Probe attenuation for each channel can be selected from the following.
1 : 1, 10 : 1, 100 : 1, 1000 : 1

Note

If an incorrect attenuation has been selected, V/div will also be incorrect. If you set the attenuation to 1:1 when using a 10:1 probe, for example, the displayed value for automatically measured amplitude will be 1/10 the true value.

Operating Procedure

1. Press one of the keys **CH1** to **CH8** to select the desired channel.
2. Keep pressing the “**Probe**” soft key until the desired attenuation is selected.

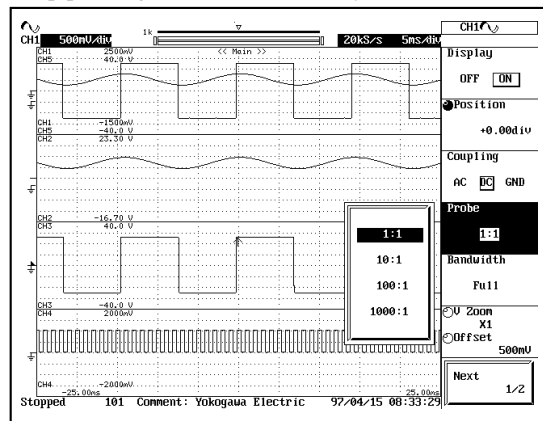

5.7 Setting the Bandwidth

(For High-Speed Isolation/High-Speed/High-Resolution, High-Voltage, Isolation/High-Resolution, Isolation/Temperature/Strain Modules)

≡ For a description of this function, refer to page 1-5. ≡

Function

Bandwidth

The following frequency bandwidth limit can be set on each input module. Each channel is set individually.

No bandwidth limit is set if "FULL" is selected.

High-Speed Isolation Module (701855) and High-Speed Module (701856) (Low pass filter)

Full, 500 kHz, 50 kHz, 5 kHz, 500 Hz

High-Resolution, High-Voltage, Isolation/High-Resolution, Isolation Module (Low pass filter, anti-aliasing filter)

Full, Auto, 4 kHz, 400 Hz, 40 Hz

If a limit other than Full or Auto is selected, low pass filter is selected for the specified frequency.

Selecting Auto automatically combines the anti-aliasing filter and low pass filter according to the sample rate as shown below and limits the frequency bandwidth.

| Sample rate | Anti-aliasing filter | Low pass filter |
|----------------|----------------------|-----------------|
| 100 kS/s | 40 kHz | OFF |
| 50 kS/s | 20 kHz | OFF |
| 20 kS/s | 8 kHz | OFF |
| 10 kS/s | 4 kHz | 4 kHz |
| 5 kS/s | 2 kHz | 4 kHz |
| 2 kS/s | 800 Hz | 4 kHz |
| 1 kS/s | 400 Hz | 400 Hz |
| 500 S/s | 200 Hz | 400 Hz |
| 200 S/s | 80 Hz | 400 Hz |
| 100 S/s | 40 Hz | 40 Hz |
| 50 S/s | 20 Hz | 40 Hz |
| 20 to 5 S/s | 20 Hz | 40 Hz |
| 2 S/s or below | 20 Hz | 40 Hz |

* Cut-off characteristic : -72 dB/1.5 fc

Temperature Module

Full, 2 Hz, 8 Hz

2 Hz is a line filter (for removing 50/60 Hz noise).

Strain Module (Low-pass filter)

Full, 1 kHz, 100 Hz, 10 Hz

Operating Procedure

1. Press one of the keys **CH1** to **CH8** to select the desired channel.
2. Press the “**Bandwidth**” soft key to change the band width setting.

High-Resolution Isolation Module

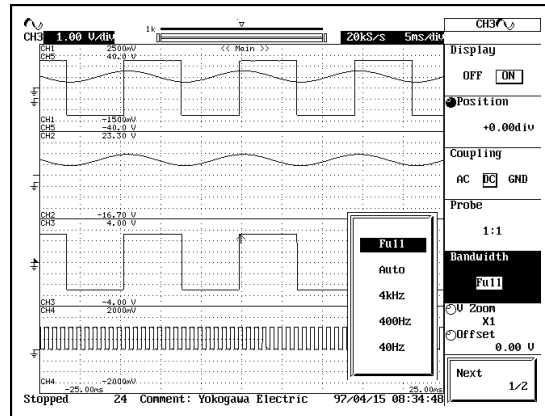

3. Repeat the above steps as necessary to set the value on other channels.

Note

You can set the bandwidth separately for each channel. Repeat steps 1 and 2 as necessary to make the settings.

5.8 Zooming in Vertical Direction

(For High-Speed Isolation/High-Speed/High-Resolution, High-Voltage, Isolation/High-Resolution, Isolation/Logic Input Modules)

≡ For a description of this function, refer to page 1-5. ≡

Function

The displayed waveform can be enlarged/reduced in vertical direction. It is useful when you wish to change the vertical axis setting after displaying waveforms using Single Start/Log Start (refer to page 4-6).

Selecting the trace to zoom

Select one waveform from CH1 to CH8.

However, if the selected waveform display is OFF, it cannot be zoomed.

Zoom factor

The following zoom factors are available.

×0.1, ×0.2, ×0.5, ×0.75, ×1, ×1.5, ×2, ×2.5, ×10, ×20, ×50 and ×100.

Zoom position

Zooms with the center at the vertical position.

When “V Zoom” is switched from “x1” to “x2”

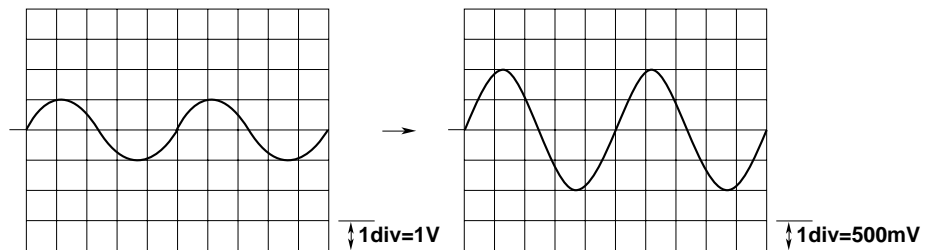

Operating Procedure

1. Press one of the keys **CH1** to **CH8** to select the channel to zoom and turn the display ON.
2. Press the “V Zoom/Offset” soft key to set jog shuttle action to “V Zoom.”
3. Turn the jog shuttle to set the desired zoom factor.

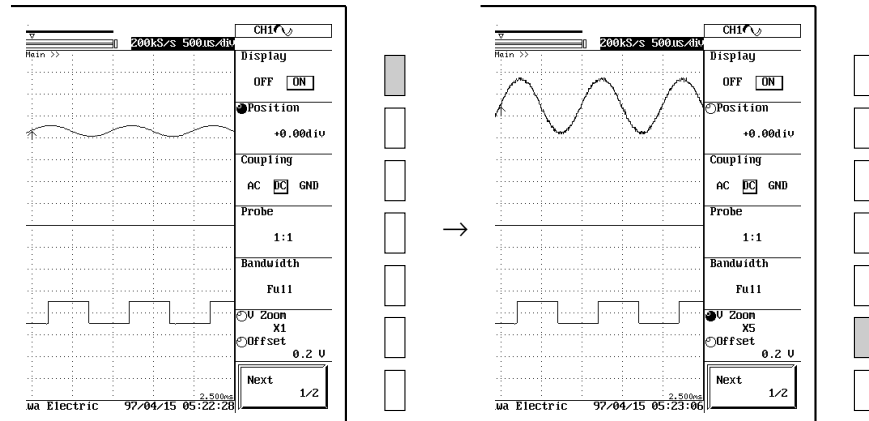

Note

- If the item being controlled by the jog shuttle is “V Zoom,” pressing the **RESET** key will set the zoom factor to x1.
- The upper section of the V/div display (upper left of the screen) when zooming in the vertical direction with “V Zoom,” is the V/div corresponding to the displayed waveform (V/div that is zoomed with “V Zoom”). The lower section is the value being set with the V/div knob (V/div before zooming with “V Zoom”).

5.9 Setting the Offset Voltage

(For High-Speed Isolation/High-Speed/High-Resolution, High-Voltage, Isolation/High-Resolution, Isolation Modules) ≡ For a description of this function, refer to page 1-5. ≡

Function

The offset voltage can be set regardless of the input coupling setting.

Offset voltage setting range

The setting range varies depending on the input module as shown below.

For High-Speed Isolation Module (701855) and High-Speed Module (701856)

| Sensitivity Range (Probe=1:1) | Offset Voltage Setting Range |
|-------------------------------|------------------------------|
| 5 mV/div to 50 mV/div | -0.5 V to 0.5 V |
| 100 mV/div to 500 mV/div | -5 V to 5 V |
| 1 V/div to 5 V/div | -50 V to 50 V |
| 10 V/div to 20 V/div | -250 V to 250 V* |

The setting resolution is 0.01 div. If the voltage scale is 5 mV/div, for example, the setting resolution will be 0.05 mV.

* Do not apply an input exceeding the maximum input voltage.

For High-Resolution, High-Voltage, Isolation/High-Resolution, Isolation Module

- The waveform can be set in the range between ± 4 div.
- The setting resolution is 0.01 div.

Canceling the offset voltage

If the item being controlled by the jog shuttle is “Offset,” pressing the **RESET** key sets the offset voltage to 0 V.

Points for attention

- The offset voltage is effective even when the acquisition is stopped.
- The offset value does not affect cursor measurements, automatic measurements, or math computations.
- If you change the probe attenuation, the offset changes proportionally to reflect the new attenuation rate.
- Changing the voltage sensitivity does usually not affect the offset value. Only if the change would cause the offset to go out of range, the offset moves to the nearest range limit. If you then return to the original sensitivity, the offset returns to its original setting as well (provided that you have not explicitly changed the value in the meantime).

Operating Procedure

Setting the offset voltage

1. Press one of the keys **CH1** to **CH8** to select the desired channel.
2. Press the “**V Zoom/Offset**” soft key to set jog shuttle action to “**Offset**.”
3. Turn the jog shuttle to set the desired offset voltage.

You can change the setting a digit using the arrow keys (located below the jog shuttle).

Canceling the offset voltage (setting it to 0 V)

You can return the offset to 0V by pressing the **RESET** key.

5.10 Using the Linear Scaling Function

(For High-Speed Isolation/High-Speed/High-Resolution, High-Voltage, Isolation/High-Resolution, Isolation Modules, For strain modules, see section 5.16.)

≡ For a description of this function, refer to page 1-19. ≡

Function

This function lets you apply linear scaling to the measurement values. If you set this feature ON, the screen displays the scaled results rather than the original measurements. The scaling relationship is

$$Y = AX + B$$

where X is the measurement value and Y is the scaled value. Note that you can select the dimensional unit for the scaled display.

Scaling coefficient (A) and offset (B)

Range for A, B : $-1.0000E+30$ to $+1.0000E+30$

Default : A $+1.0000E+00$, B $+0.0000E+00$

Dimensional unit

Unit identifier (alphanumeric string) of up to four characters.

Displaying Upper and Lower Limits

Depending on the values of A and B for the linear scaling, the upper and lower limits of the vertical axis for displaying the waveform may not be well-rounded values. If you set “Linear Scale Rounding” to ON, the waveform is displayed so that 1 div of the vertical axis is adjusted to well-rounded values of 1-2-5 steps.

Example

If 5.0V/div, A=1.2345E+00, and B=5.4321E+00, the upper and lower limits of the waveform display are as follows.

“Linear Scale Rounding” is OFF : $3.0122E+01/-1.9258E+01$ (0.61725E+00/div)

“Linear Scale Rounding” is ON : $5.000E+01/-3.000E+01$ (1.000E+01/div)

Operating Procedure

1. Press a channel key (**CH1** to **CH8**) to select the channel you want to set.
2. Press the “Next 1/2” soft key.
3. Press the “Linear Scaling” soft key to select ON.
4. Press the “Ax+B:A” soft key, and then set the A value using the jog shuttle.
You can use the arrow keys to move to different columns within the value.
5. Press the “Ax+B:B” soft key, and then set the B value.
6. If necessary, press the “Units” soft key and enter the unit string at the keyboard.

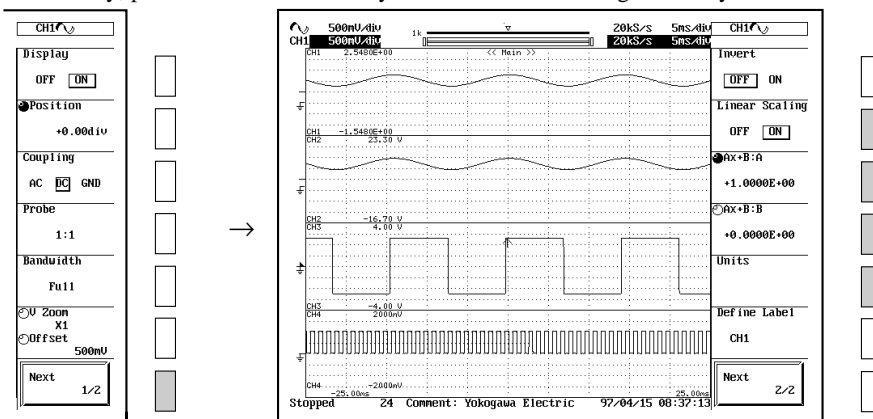

Enabling/Disabling rounding of the upper and lower limits of the waveform display

1. Press the **MISC** key.
2. Press the “Next” soft key to display the “Next2/2” menu. Then, press the “Others” soft key.
3. Press the “Linear Scale Rounding” soft key and select “ON” or “OFF.”

When $A=1.2345E+00$, $B=5.4321E+00$

Linear Scale Rounding:OFF

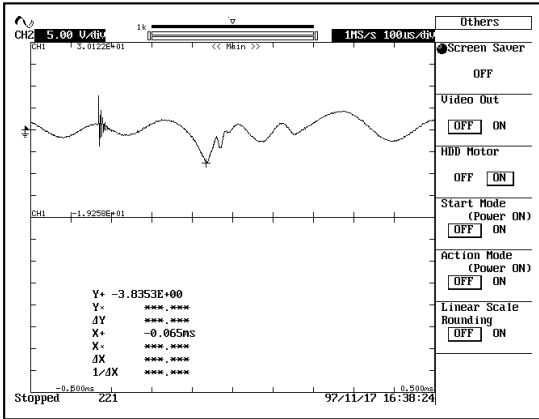

Linear Scale Rounding:ON

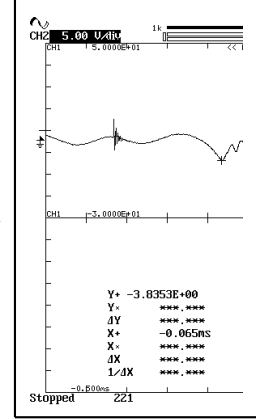

Note

- Linear scaling is not available for the following waveforms.
 - Snapshot waveforms
 - Accumulated waveforms (except for newest waveform)
 - History-memory waveforms (except for “Selected Record No.”)
- You can set linear scaling separately for each channel.
- The A and B values remain in memory after you switch the linear scaling function OFF, and are restored if you switch the function back on.
- Mathematical computations operate with respect to the scaling results.

5.11 Inverting a Waveform

(For High-Speed Isolation/High-Speed/High-Resolution, High-Voltage, Isolation/High-Resolution, Isolation Modules) ≡ For a description of this function, refer to page 1-5. ≡

Function

Relevant channels

The input signals to channels CH1 to CH8 can be inverted independently of one another. Inversion is performed about the vertical position.

Points for attention

- If you change the invert display setting while the waveform acquisition is stopped, the display does not change. The waveform will be displayed inverted the next time you start the acquisition.
- Cursor measurements, automatic measurement of waveform parameters, and computation functions do not give correct results if the waveform is inverted and the offset is non-zero.
- You can not invert the waveform while realtime printing or realtime recording. The waveform is inverted when you stop the waveform acquisition.

Operating Procedure

1. Press one of the keys **CH1** to **CH8** to select the desired channel.
2. Press the “**Next 1/2**” soft key.
3. Press the “**Invert**” soft key until “**ON**” is selected.

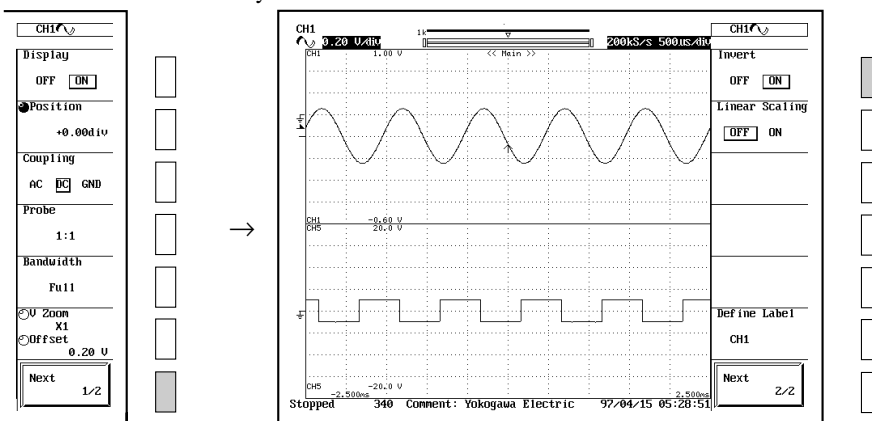

5.12 Setting the ON/OFF of Channels and the V/div with the All Channel Setting Menu

Function

The ON/OFF of each channel and the V/div setting are explained in pages 5-1 and 5-4 respectively. This section explains the procedure in displaying information on all the channels simultaneously and setting the ON/OFF and V/div settings for the individual channels. Note that, channels that have temperature modules or logic input modules installed can not set the V/div settings.

Display of the all channel setting menu

The all channel setting menu is displayed after carrying out the following operating procedure.

- When the **ESC** key is pressed repeatedly
- Just after initialization has been completed
- Just after auto set-up has been completed
- When data is loaded from the floppy disk/internal hard disk/external SCSI device

Operating Procedure

Selecting the channels

1. In any of the above cases, the all channel setting menu appears as shown below.
2. Turn the jog shuttle to select the desired channels.
Proceed to step 3 or 4 depending on which settings you want to make.

Turning the channel ON/OFF

3. Press the **SELECT** key to select "ON" or "OFF".

Setting the V/div

4. Turn the **V/DIV** knob to set the desired V/div value.

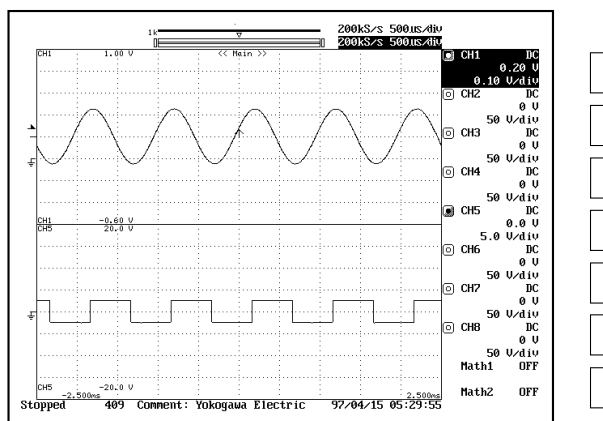

5. Repeat steps 2 to 4 until you have made all the settings you want.

Note

Channels which do not have input modules installed are not displayed on the all channel setting menu.

5.13 Setting the Temperature Measurement

(For Temperature Module)

≡ For a description of this function, refer to page 1-6. ≡

Function

Types of thermocouples

Select the appropriate type that matches the thermocouple being used.

The following types of thermocouples are available.

When the input terminal is left open, the displayed value goes below the lower limit of the measurement range.

| Type | Measurement range |
|-----------|-------------------|
| K | -200 to 1300°C |
| E | -200 to 800°C |
| J | -200 to 1100°C |
| T | -200 to 400°C |
| L | -200 to 900°C |
| U | -200 to 400°C |
| N | 0 to 1300°C |
| R | 0 to 1700°C |
| S | 0 to 1700°C |
| B | 0 to 1800°C |
| W | 0 to 2300°C |
| KPvsAu7Fe | 0 to 300K |

Temperature unit

Select the temperature unit from °C, °F, and K. The default setting is °C.

Display range

To display the measured waveform, the upper and lower limits need to be set according to the input.

- Available range
 - 3000 to 3000°C (The setting resolution is 0.1°C.)
 - 2726.8 to 3273.2K (The setting resolution is 0.1K.)
 - 5368.0 to 5432.0°F (The setting resolution is 0.1°F.)

ON/OFF of RJC

This instrument normally performs reference junction compensation with the built-in RJC circuit when measuring temperature with the thermocouple. When checking the temperature measurement value, or when using an external reference junction (0°C), the internal reference junction compensation needs to be disabled.

This instrument allows you to select whether to use or not to use the internal reference junction compensation.

Normally, this is set to ON.

Note

With the RJC turned off, if a voltage corresponding to a certain maximum temperature is applied at the input and the measured temperature is off as compared with the maximum temperature, the instrument may be damaged. Please contact your nearest YOKOGAWA dealer listed on the back cover of this manual.

Operating Procedure

1. Press one of the keys (channel key which has the Temperature Module installed) **CH1** to **CH8** to select the channel.

Select the type of thermocouple

2. Press the **“Type”** soft key to select the desired type.

Set the display range

3. Press the **“Upper Scale”** soft key to set jog shuttle action to **“Upper Scale.”**
4. Turn the jog shuttle to set the upper limit.
You can change the setting a digit using the arrow keys (located below the jog shuttle).
5. In the similar way, set the lower limit with **“Lower Scale.”**

Select the temperature unit

6. Press the **“Unit”** soft key to select the desired unit.

ON/OFF of RJC

7. Press the **“RJC”** soft key to select **“ON”** or **“OFF.”**

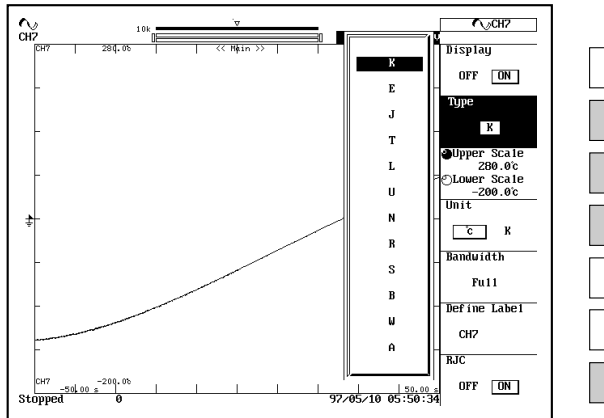

5.14 Setting the Logic Probe

(For Logic Input Module)

Function

ON/OFF of bit display: Bit Display

Allows you to select whether or not to display the waveform for each bit.

Mapping the logic waveform: Bit Mapping

OFF : The spaces for the bit waveforms that are turned OFF are maintained.

ON : The spaces for the bit waveforms that are turned OFF are not maintained. Only the bit waveforms that are turned ON are displayed in order from the top.

OFF(when Bit7=OFF on POD A)

| |
|----|
| A1 |
| A2 |
| A3 |
| A4 |
| A5 |
| A6 |
| |
| A8 |

ON(when Bit7=OFF on POD A)

| |
|----|
| A1 |
| A2 |
| A3 |
| A4 |
| A5 |
| A6 |
| A8 |
| |

Operating Procedure

1. Press one of the keys (channel key which has the logic input module installed) **CH1** to **CH8** to select the channel.
2. Press the **“Bit Display”** soft key to display the display ON/OFF setting screen.
3. Move the cursor to the bit you wish to turn ON with the jog shuttle.
4. Press the **SELECT** key to turn it ON.
 Selecting **“ALL ON”** turns all items ON at once.
 Selecting **“ALL OFF”** turns all items OFF at once.
5. Repeat steps 3 and 4 as necessary.

Mapping the logic waveform

6. Press the **“Bit Mapping”** soft key to select **“ON”** or **“OFF.”**

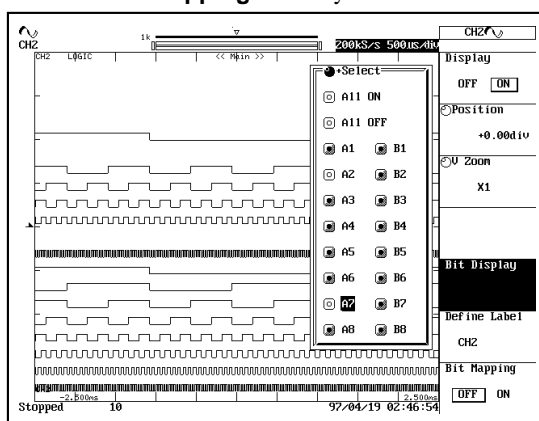

5.15 Setting the Strain Measurement

(For Strain Module)

Function

Selecting the measurement range : Range

Select the range according to the magnitude of the strain to be measured.

20000uSTR, 10000uSTR, 5000uSTR, 2000uSTR, 1000uSTR

uSTR stands for 10^{-6} strain.

For the measurement range, see section 15.22.

Selecting the display range : Upper Scale/Lower Scale

To make the viewing of the measured waveform easier, you can change the upper and lower limits of the display range according to the input.

Setting range : -30000 to $+30000$ uSTR

Make sure to set the upper scale value to be larger than the lower scale value.

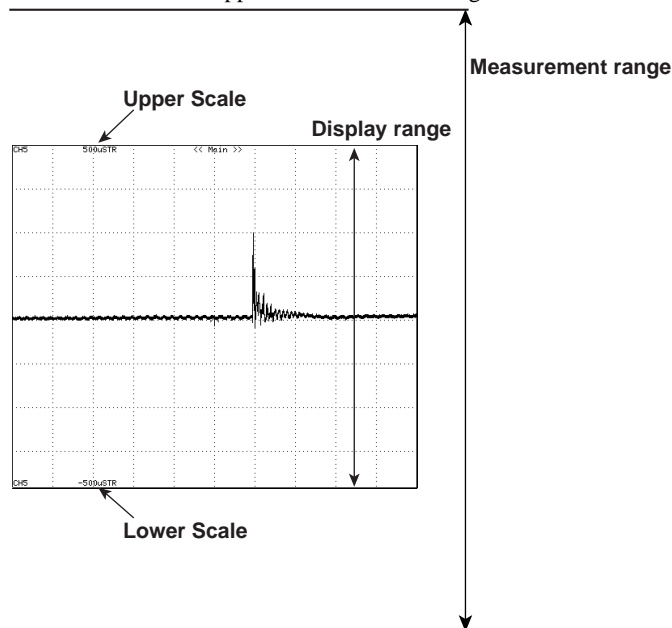

Selecting the bridge voltage : Excitation

You can select the voltage to apply to the bridge head.

- 2 V : When the resistance of the bridge head (bridge resistance) is 120Ω or more.
- 5 V : When the bridge resistance is 350Ω or more

You cannot change the bridge voltage during a waveform acquisition.

Setting the gauge factor : Gauge Factor

You can set the gauge factor of the strain gauge.

Setting range : 1.90 to 2.20 (in 0.01 steps)

The gauge factor is a constant that is specific to the strain gauge, and is normally indicated in the manual for the strain gauge. If the gauge factor is outside the range specified above, calculate the measurement value according to section 5.16 "Using the Linear Scaling Function for the Strain."

You cannot change the gauge factor during a waveform acquisition.

Setting the bandwidth : Bandwidth

See section 5.7 "Setting the Bandwidth."

Executing balancing : Balance

The unbalanced portion of the bridge resistance is automatically corrected. The balancing takes a few seconds.

Balance range : $\pm 10000\text{uSTR}$

Precautions when making strain measurements

- If there is no strain gauge bridge (bridge head) or strain gauge transducer connected to the channel you wish to balance, calibration fails.
- Select a bridge voltage of 5 V when the bridge resistance is 350 Ω or more. Applying a bridge voltage of 5 V when the bridge resistance is less than 350 Ω results in incorrect measurements.
- When using the strain gauge transducer, make sure to set the bridge voltage within the recommended voltage range of the transducer.
- If any one of the specified channels fails to balance, then an error message and information about the channel that failed are displayed.
- If the power is turned ON, a new strain gauge is connected, or the bridge voltage or the gauge factor is changed, you need to balance again.

Operating Procedure

1. Press one of the keys (channel key that has the strain module installed), **CH1** to **CH8**, to select the channel.

Select the measurement range

2. Press the “Range” soft key and select one from “20000uSTR” to “1000uSTR.”

Set the display range

3. Press the “Upper Scale/Lower Scale” soft key and set the jog shuttle action to “Upper Scale.”
4. Turn the jog shuttle to set the upper limit.
You can change the setting a digit using the arrow keys.
5. Similarly, set the lower limit with “Lower Scale.”

Select the bridge voltage

6. Press the “Excitation/Gauge Factor” soft key to select “2V” or “5V.”

Set the gauge factor

7. Continuing from step 6, turn the jog shuttle to set the gauge factor.

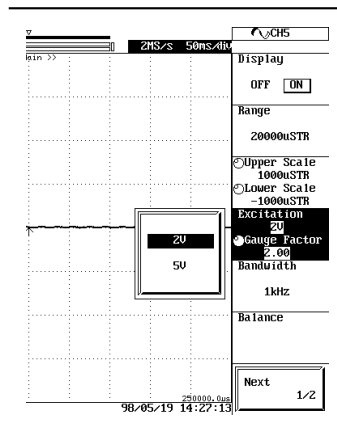

Execute balancing

8. Press the “**Balance**” soft key to display the channel selection menu.
9. Turn the jog shuttle to move the cursor to the channel that you wish to balance.
10. Press the **SELECT** key to turn it ON.
11. Repeat steps 9 and 10 for all of the channels you wish to balance.
12. Move the cursor to “**Balance**” using the jog shuttle.
13. Press the **SELECT** key to execute the balancing.

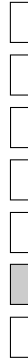
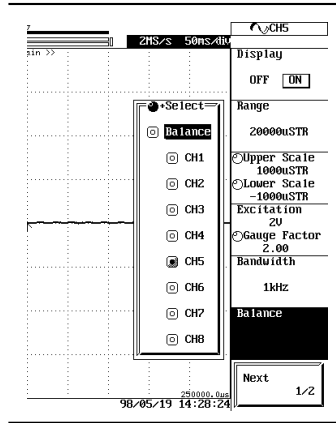

5.16 Using the Linear Scaling Function for the Strain

(For Strain Module)

Function

Linear Scaling

Selecting the linear scaling method : Linear Scaling

- Select the linear scaling method from the following.
 - **OFF**
No linear scaling is performed.
 - **Ax+B**
The setting range and the initial setting of the scaling coefficient A and offset value B are the same as described in section 5.10 “Using the Linear Scaling Function.”
 - **P1-P2**
Arbitrary scale values (P1:Y, P2:Y) are set against two arbitrary measurement values (P1:X, P2:X). The scale converting equation ($y=ax+b$) is determined from these four values.
 - Measurement value (P1:X, P2:X) range : Same as the measurement range (see section 15.22).
 - Scale value (P1:Y, P2:Y) range : $-1.0000E+30$ to $+1.0000E+30$
 - Initial setting of scale values : P1:X 0.0uSTR, P1:Y $+0.0000E+00$
: P2:X 1.0uSTR, P2:Y $+1.0000E+00$

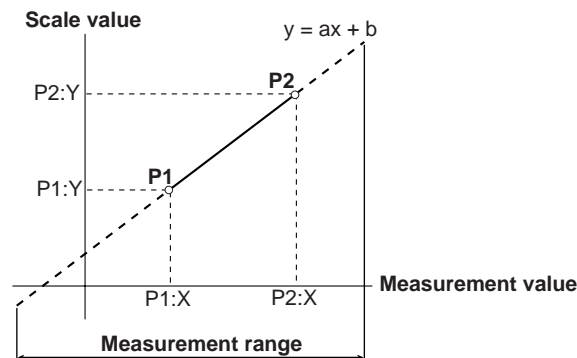

• Reading in the measurement values : Get Measure

When “P1-P2” is selected for the linear scaling method, you can read in the waveform data into P1:X and P2:X while the waveform acquisition is started.

- During roll mode display
The data when the “Get Measure” soft key is pressed are read in.
- During update mode (not roll mode)
The last data of the displayed waveform when the “Get Measure” soft key is pressed are read in.

Setting the unit : Unit

The unit setting is the same as described in section 5.10 “Using the Linear Scaling Function.”

Operating Procedure

1. Press one of the keys (channel key that has the strain module installed), **CH1** to **CH8**, to select the channel.
2. Press the “**Next1/2**” soft key.

Select the linear scaling

3. Press the “**Linear Scaling**” soft key to select one from “**OFF**” to “**P1–P2**.” If you select OFF, the operating procedure ends here.

When “**Ax+B**” is selected

4. Press the “**Ax+B:A**” soft key and set the value of A with the jog shuttle.
You can change the setting a digit using the arrow keys.
5. Press the “**Ax+B:B**” soft key and set the value of B in a similar manner.

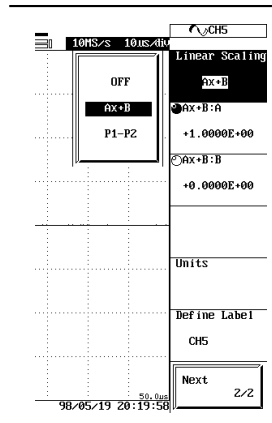

When “P1–P2” is selected

4. Press the “P1:X/P1:Y” soft key and set the jog shuttle action to “P1:X.” “P1:X” is displayed in the “Get Measure” soft key.
5. Press the “Get Measure” soft key to read in the measured value into P1:X or set the value with the jog shuttle.
You can change the setting a digit using the arrow keys.
6. Press the “P1:X/P1:Y” soft key again and set the jog shuttle action to “P1:Y.”
7. Set the scale value P1:Y with the jog shuttle.
You can change the setting a digit using the arrow keys.
8. Press the “P2:X/P2:Y” soft key and set the jog shuttle action to “P2:X.” “P2:X” is displayed in the “Get Measure” soft key.
9. Press the “Get Measure” soft key to read in the measured value into P2:X or set the value with the jog shuttle.
You can change the setting a digit using the arrow keys.
10. Press the “P2:X/P2:Y” soft key again and set the jog shuttle action to “P2:Y.”
11. Set the scale value P2:Y with the jog shuttle.
You can change the setting a digit using the arrow keys.

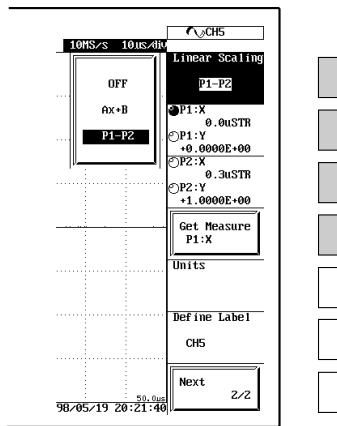

Set the unit

If necessary, press the “Units” soft key to display the keyboard, then input the name of the unit. For the procedures on entering character strings, see section 4.1 “Entering Values and Character Strings.”

6.1 Setting the Trigger Mode

≡ For a description of this function, refer to page 1-10. ≡

Function

Auto mode

Auto mode is the one which is used normally. The display is updated in the following two cases.

- When the trigger conditions are met: Updated when the trigger conditions are met
- When 50 ms elapses without trigger conditions being met: Updated automatically

In auto mode, the waveform can still be observed even if no trigger is activated, hence it is useful when you want to check the waveform and ground level even when no trigger is detected. However, if the period of the trigger signal is 50 ms or longer, the above two conditions will be satisfied alternately. In this case, use normal mode.

Auto level mode

- If a trigger is activated before timeout, it displays the waveform in the same way as in auto mode.
- If the trigger is not activated within the timeout time, then the center value of the amplitude of the trigger source is detected, and the trigger level is changed to that value. The trigger is activated using the new value and the displayed waveform is updated.
- This mode can only be selected for simple triggers.

Normal mode

The display is updated only when the trigger conditions are met. The display will not be updated if no trigger occurs. Therefore, to check the waveform or ground level when no trigger is detected, you must use auto mode.

Timer Trigger*

The trigger is activated at the specified interval from the specified time.

* This function is available on DL708Es with firmware versions 4.00 or later.

Note

- Pressing the “**Single Start**” or “**Log Start**” soft key acquires the waveform once and displays it. Refer to page 4-6.
- The trigger mode setting applies to both simple and enhanced triggers.
- In the normal mode when the maximum acquisition count is set to one (see section Appendix 2), if you press the stop key when the waveform acquisition is in the “Waiting for trigger” state, then the displayed waveform is updated with the waveform when the key was pressed.
- Triggers are ignored when realtime printing to the built-in printer or realtime recording to the internal hard disk.

Operating Procedure

1. Press the **SIMPLE** key or the **ENHANCED** key.
2. Press the “**Mode**” soft key to select “**Auto**”, “**Normal**”, “**AT-Level** (for simple triggers only)”, or “**Time** (for simple triggers only)*.”

Simple trigger mode

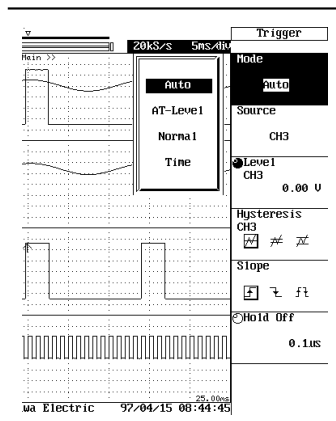

Enhanced trigger mode

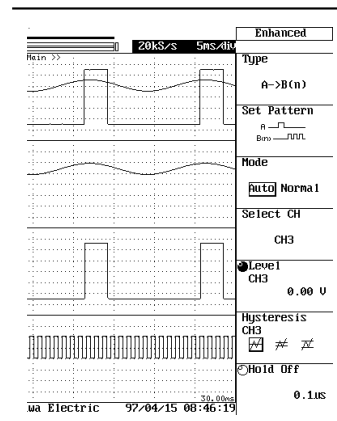

* This function is available on DL708Es with firmware versions 4.00 or later.

6.2 Selecting a Channel for Setting Trigger Hysteresis and Trigger Level

Function

Selects the channel (trigger source) for setting parameters such as trigger hysteresis and trigger level.

If you use a simple trigger, only the selected channel serves as the trigger source. If you use an enhanced trigger, the trigger source is generated using all channels selected within the “Set Pattern” function.

The following traces are available for trigger source.

- CH to CH8 (CH2, CH4, CH6)
- EXT (the TRIG IN terminal on the left side)
- LINE (commercial power supply signal)

Note

The items to set are different when CH1 to CH8 is selected and when EXT or LINE is selected.

- CH1 to CH8 : hysteresis (Section 6.3), trigger level (Section 6.4), slope (simple trigger only, Section 6.8)
- CH1 to CH8 (for logic input module) : slope (simple trigger only, Section 6.8), Logic Bit No. (simple trigger only, Section 6.8), Set Pattern (enhanced trigger only, Section 6.9 to 6.14)
- EXT : slope (simple trigger only, Section 6.8)
- LINE : There are no trigger hysteresis/trigger level settings

Operating Procedure

1. Press the **SIMPLE** key or the **ENHANCED** key.
2. Press the **Source** soft key to display the trigger source menu.
3. Keep pressing the **Source** soft key to select the desired trigger source from channels **CH1** to **EXT*** and **LINE***.

Channels which do not have input modules installed are not displayed on the menu.

* Available only on simple trigger.

Simple trigger mode

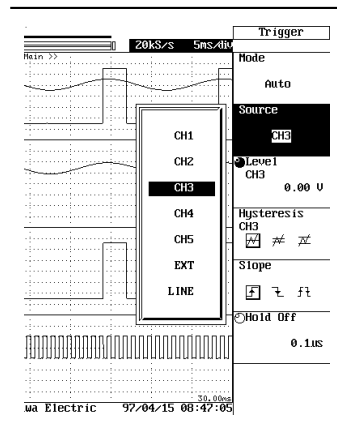

Enhanced trigger mode

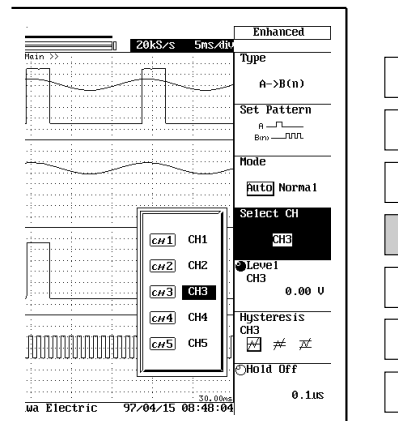

6.3 Setting Trigger Hysteresis for Channels 1 to 8

(For High-Speed Isolation/High-Speed/High-Resolution, High-Voltage, Isolation/High-Resolution, Isolation/Temperature/Strain Modules)

≡ For a description of this function, refer to page 1-10. ≡

Function

Setting the trigger hysteresis

Allow the trigger level to have a width, so that the trigger does not get activated due to small fluctuations in the signal. Select the trigger hysteresis from the following three choices.

• For voltage modules

∇ : Hysteresis of about ± 0.1 div centered on the trigger level.

∇ : Hysteresis of about ± 0.5 div centered on the trigger level.

∇ : Hysteresis of about ± 1 div centered on the trigger level.

• For temperature modules

∇ : Approx. $\pm (0.5 \times$ the setting resolution of the trigger level)

∇ : Approx. $\pm (1 \times$ the setting resolution of the trigger level)

∇ : Approx. $\pm (2 \times$ the setting resolution of the trigger level)

* For the setting resolution of the trigger level, see section 6.4.

• For strain modules

∇ : Hysteresis of approx. $\pm 2.5\%$ of the selected measurement range centered on the trigger level.

∇ : Hysteresis of approx. $\pm 12.5\%$ of the selected measurement range centered on the trigger level.

∇ : Hysteresis of approx. $\pm 25\%$ of the selected measurement range centered on the trigger level.

* For the measurement range, see section 5.15.

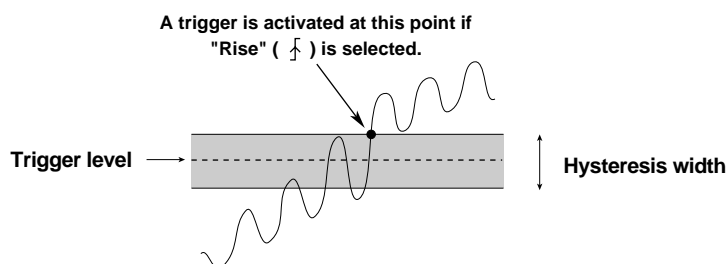

Operating Procedure

Setting the trigger hysteresis

1. Press the **SIMPLE** key or the **ENHANCED** key.
2. Press the "Hysteresis" soft key to select " ∇ ", " ∇ " or " ∇ ".

Simple trigger mode

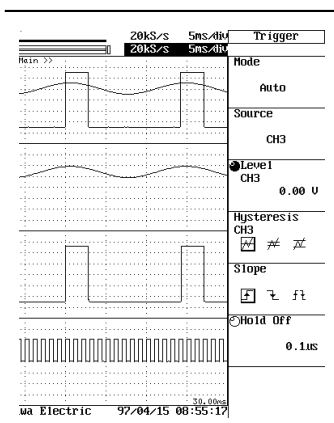

Enhanced trigger mode

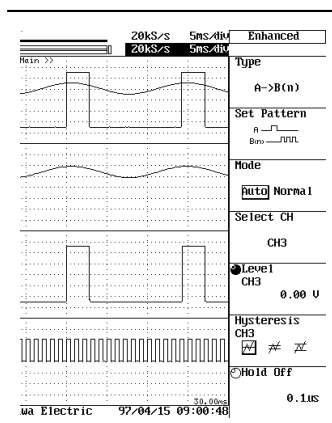

Note

The trigger hysteresis applies to both the simple and enhanced trigger.

6.4 Setting the Trigger Level

(For High-Speed Isolation/High-Speed/High-Resolution, High-Voltage, Isolation/High-Resolution, Isolation/Temperature/Strain Modules)

≡ For a description of this function, refer to page 1-10. ≡

Function

Trigger level setting range

CH1 to CH8 : 8 divisions

For voltage modules, the setting resolution is 0.1 div. If the voltage scale is 2 mV/div, for example, the setting resolution will be 0.2 mV.

Canceling the trigger level

You can press the **RESET** key to set the trigger level equal to the current offset value.

Resolution for setting the trigger level (for temperature module)

The trigger level can be set within the measurement range. The measurement range varies according to the type of thermocouple (TC). For details, see page 5-16.

The resolutions used to set the trigger level are as follows:

| Type of TC | Resolution | Type of TC | Resolution |
|---------------|------------|------------|------------|
| K, E, J, L, N | 6.4°C | T, U | 3.2°C |
| R, S, B, W | 12.8°C | KPvsAu7Fe | 1.6°C |

Resolution for setting the trigger level (for strain module)

The trigger level can be set within the measurement range. For details on the measurement range, see page 15-15.

The resolutions used to set the trigger level are as follows:

| Range | Resolution | Range | Resolution |
|----------|------------|-----------|------------|
| 1000uSTR | 6.4uSTR | 10000uSTR | 64uSTR |
| 2000uSTR | 16uSTR | 20000uSTR | 160uSTR |
| 5000uSTR | 32uSTR | | |

uSTR stands for 10^{-6} strain.

Operating Procedure

Setting the trigger level

1. Press the **SIMPLE** key or the **ENHANCED** key.
2. If jog shuttle action is not set to "Level", press the "Source" or "Select CH" soft key to set the action to Level.
3. Turn the jog shuttle to set the desired trigger level. You can change the setting a digit using the arrow keys (located below the jog shuttle).

Simple trigger mode

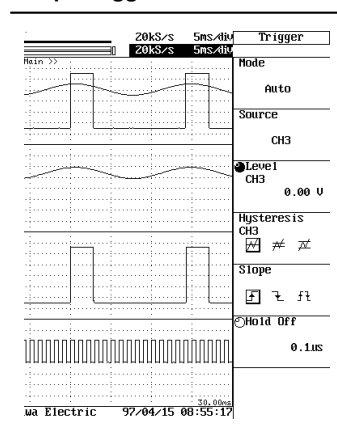

Enhanced trigger mode

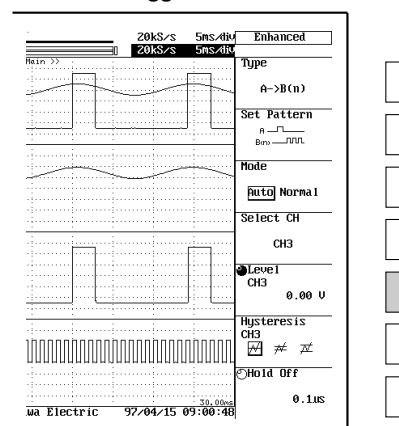

Canceling the trigger level

To set the trigger level equal to the current offset voltage: Press the **RESET** key.

Note

- The trigger level set applies to both the simple and enhanced trigger.
- When using the enhanced trigger, set the trigger levels on all channels which use conditions A and B. The trigger level set on each channel will be the reference for H and L.
- If the trigger source is a logic input, set the bit status (H/L/X) with "Bit No." or "Bit Pattern" for each bit being used.

6.5 Setting the Hold off Time

≡ For a description of this function, refer to page 1-11. ≡

Function

This function prevents a trigger from being activated for a specified time, even if the trigger conditions are met during this time. This is useful when you want to activate a trigger after a certain repetitive period of time as illustrated in the example below.

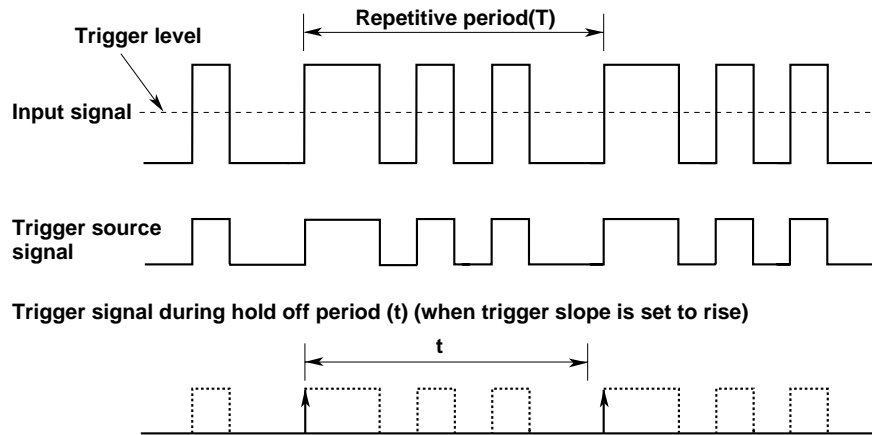

Hold off time setting range

0 ns to 1 s (default: 0 ns)

The setting resolution is 500 ns.

Points for attention

- If holdoff time is set to 50 ms or above, the trigger mode should be set to “normal.”
- When used with the A→B(n) or A Delay B trigger, the holdoff time operates with respect to condition A only.

Operating Procedure

1. Press the **SIMPLE** key or the **ENHANCED** key.
2. If jog shuttle action is not set to “Hold Off”, press the “Hold Off” soft key to set the action to Hold Off.
3. Turn the jog shuttle to set the desired hold off time.
You can change the setting a digit using the arrow keys (located below the jog shuttle).
Pressing the **RESET** key, then turning the jog shuttle sets the hold off time to 0 s.

Simple trigger mode

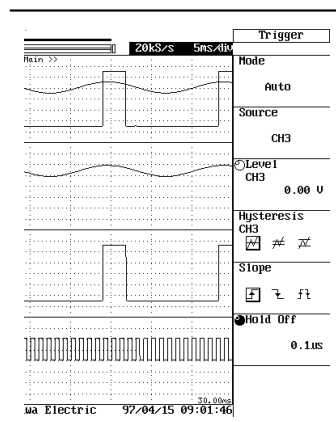

Enhanced trigger mode

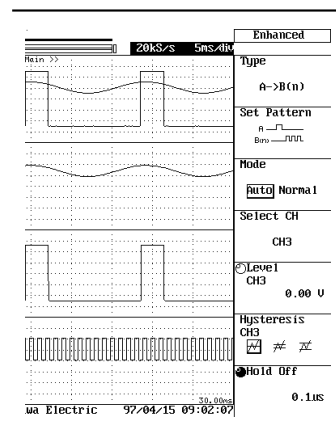

Note

The hold off time set applies to both the simple and enhanced trigger.

6.6 Setting the Trigger Position

≡ For a description of this function, refer to page 1-11. ≡

Function

Trigger Position

Specify which part of the acquired waveform in the acquisition memory to display on the screen by setting the trigger position. If the trigger delay is 0 s, the trigger position is equivalent to the trigger point.

Trigger delay : 0 s, Trigger position : 50 %

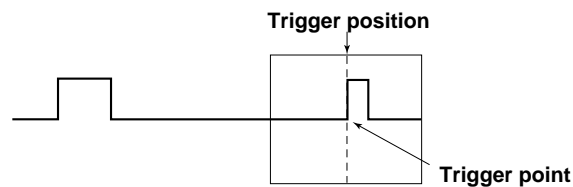

Setting range for trigger position

Taking the record length to be 100%, set a value between 0 to 100% (in steps of 1%).

Position marker

The ▽ mark on the line above the screen indicates the position of the trigger position with respect to the entire record length.

When the display record length is less than the set record length, there are waveforms that are not displayed on the screen. In this case, the trigger position may not be on the current displayed screen. To observe the area near the trigger position, move the waveform display position with “Main Position” of the zoom function.

Display record length < Record length

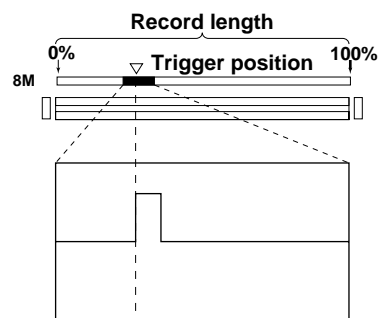

Display record length = Record length

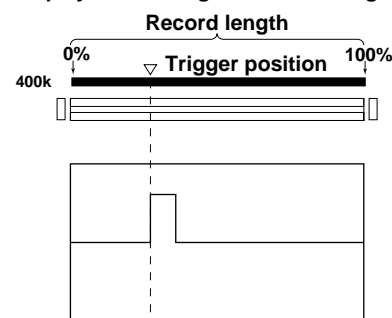

Points for attention

- If you change the trigger position while waveform acquisition is suspended, the new setting will not become effective until acquisition is resumed and the waveform is updated.
- Note that cursor time measurements are with respect to the trigger position. Changing the trigger position therefore changes the measurement values (except during roll-mode display).
- When you change the T/div setting, the time axis setting is rescaled with respect to the trigger position.

Operating Procedure

1. Press the **POSITION/DELAY** key.
 2. Press the “**Position**” soft key.
 3. Turn the jog shuttle to set the trigger position.
- You can change the setting a digit using the arrow keys (located below the jog shuttle).
You can reset the position to 50% by pressing the **RESET** key.

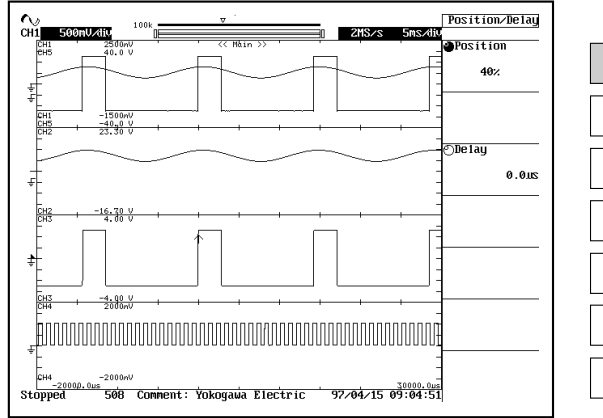

6.7 Setting the Trigger Delay

≡ For a description of this function, refer to page 1-11. ≡

Function

Although the display usually shows the waveform before and after the trigger point, using the delay function, it is possible to display the acquired waveform after a fixed time period elapses.

Setting range for trigger delay

0 to 1 s (Resolution is 500 ns)

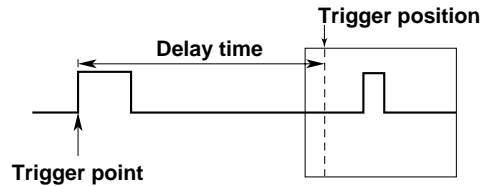

Points for attention

When T/div is changed, the trigger delay remains unchanged.

Operating Procedure

1. Press the **POSITION/DELAY** key.
2. Press the **“Delay”** soft key to set jog shuttle action to Delay.
3. Turn the jog shuttle to set the desired trigger delay.
You can change the setting a digit using the arrow keys (located below the jog shuttle).
You can reset the delay to 0s by pressing the **RESET** key.

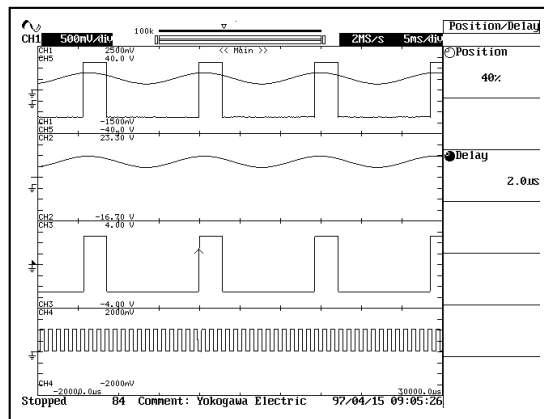

6.8 Setting the Edge Trigger (SIMPLE)

≡ For a description of this function, refer to page 1-7. ≡

Function

An edge trigger is generated when the trigger source crosses the trigger level in the specified direction.

Setting the trigger mode

Refer to Section 6.1.

Selecting the trigger source

Refer to section 6.2.

Setting the trigger coupling and HF rejection

Refer to Section 6.3.

Setting the trigger level

Refer to Section 6.4.

Setting the holdoff time

Refer to Section 6.5.

Setting the trigger slope

The trigger is generated only if the source signal crosses the specified trigger level in the specified direction. The direction is determined by the slope setting.

↗ : Updates the displayed waveform when the level of the trigger source changes from a level below the trigger level to one above the trigger level.

↘ : Updates the displayed waveform when the level of the trigger source changes from a level above the trigger level to one below the trigger level.

↗↘ : Updates the displayed waveform in either of the above cases.

If the trigger source is a logic input channel, press the “Logic Bit No.” soft key and select the bit to set the trigger slope.

Operating Procedure

Setting the trigger slope

1. Press the **SIMPLE** key.
2. Press the “Slope” soft key to select “↗”, “↘” or “↗↘”.

When the trigger source is logic input

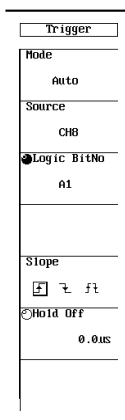

When the trigger source is anything other than logic input

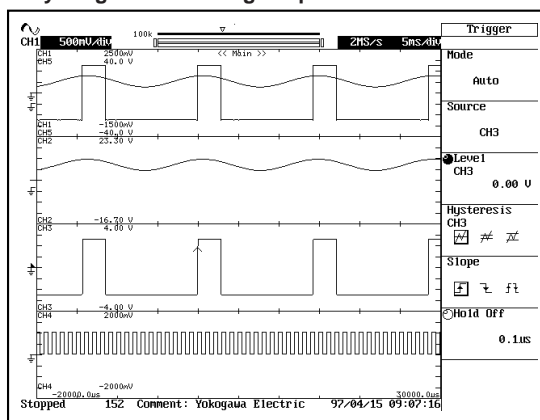

Other settings

3. You must also set the following parameters: trigger mode, trigger source, trigger level, trigger hysteresis, and holdoff time. For information about how to set these parameters, refer to Sections 6.1 to 6.7.

6.9 Setting the A→B (n) Trigger (ENHANCED)

≡ For a description of this function, refer to page 1-7. ≡

Function

This function activates a trigger the n'th time condition B becomes true after condition A has become true.

Condition A, B settings

- **Status of each channel:Status**

Select from the following.

For Modules Other than Logic Input Module

- H : Above the preset trigger level
- L : Below the preset trigger level
- X : Don't Care

For Logic Input Modules (Condition B cannot be set)

- O : Make the combination of the status*¹ of each bit the trigger condition
- X : Don't Care

*1 The status of each bit is selected from the following.

- H : Above a certain level*²
- L : Below a certain level*²
- X : Don't Care

*2 Varies depending on the logic probe being used as follows.

- 700986 : approx. 1.4 V
- 700987 : 6 V ± 50% (during DC)
- 700987 : 50 V ± 50% (during AC)

- **Condition**

Select from two conditions, as follows.

Enter : Trigger is activated when all channels come to meet selected status.

Exit : Trigger is activated when one (or more) channel moves out of selected status.

Pattern B repeating count

1 to 255 count

Other settings

Refer to sections 6.1 to 6.7 for details on how to set the trigger mode, trigger level, trigger hysteresis, and holdoff time.

Note

- If you would like to define only 1 pattern condition, please define A condition only and set all the status of the B condition to X (Don't care). Trigger condition can not be satisfied if all the status of the A condition is set to X.
- If you would like to set the trigger only on the condition of the status of each bit (trigger on the AND of each bit), then make the following settings.
Status of condition A : Set "O" for logic input channels that are to be used. Set all other channels to "X" (Don't care). → Steps 4 to 11.
Status of condition B : Set all channels to "X" (Don't care). → Step 12
Set the status of each bit. → Steps 16 to 18

Operating Procedure

Setting the trigger type

1. Press the **ENHANCED** key.
2. Press the "**Type**" soft key to display the trigger type menu.
3. Keep pressing the "**Type**" soft key to select "**A→B(n)**".

Setting the condition A

4. Press the “Set Pattern” soft key to display the A→B(n) trigger setting menu.
5. Turn the jog shuttle to move the cursor to the <Parallel A> “Condition.”
6. Press the **SELECT** key to display the <Parallel A> “Condition” menu.
7. Press the **SELECT** key to select “Enter” or “Exit.”

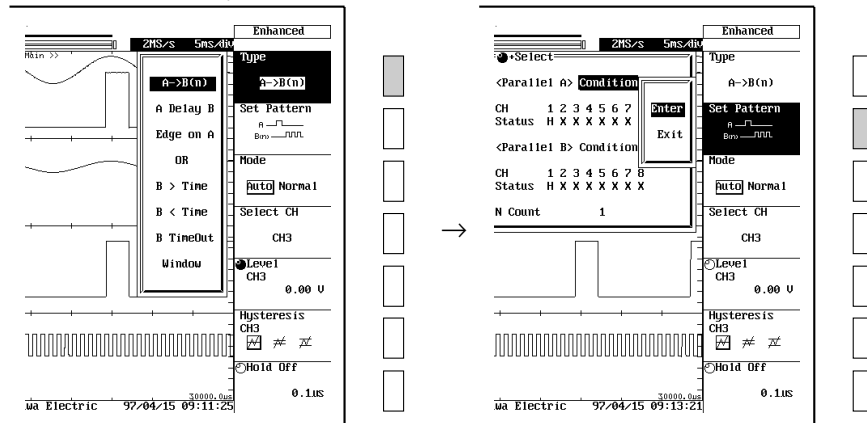

Setting the channel status for condition A

8. Turn the jog shuttle to move the cursor to “CH1.”
9. Press the **SELECT** key to display the CH1 menu.
10. Press the same **SELECT** key the appropriate number of times to select from “H,” “L” and “X” (“O” and “X” for logic input).
11. Repeat the above steps to set the channel status for CH2 to CH8.

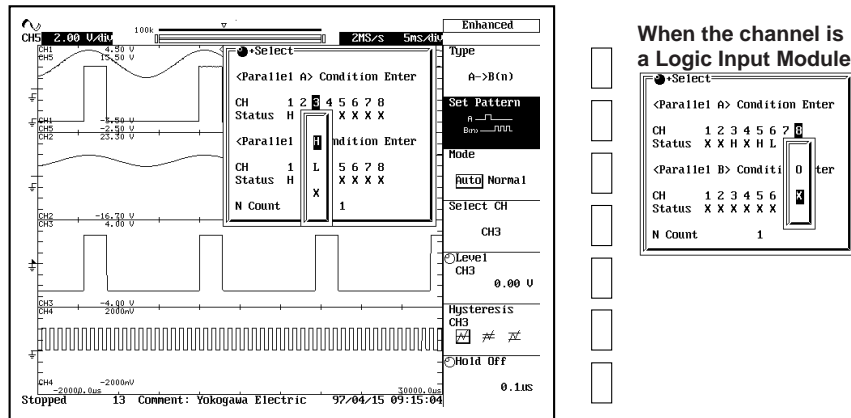

When the channel is a Logic Input Module

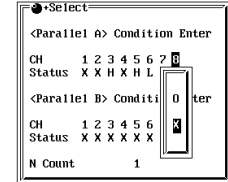

Setting the condition B and channel status

12. Repeat steps 5 to 11 to set the condition B and channel status.

Setting the condition B repeating count

13. Turn the jog shuttle to move the cursor to “N Count.”
14. Press the **SELECT** key to display the “N Count” menu.
15. Turn the jog shuttle to set the desired repeating count (n) for condition B.
You can change the value of the digit using the cursor key (located below the jog shuttle). Pressing the **RESET** key, resets the repeating count to “1.”

Setting the status of each bit on the logic input channel

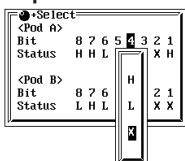

Setting the conditions of POD A and B (when using the logic input channel only)

16. Press the “Bit Pattern” soft key. (This key is not displayed unless logic input channel is selected with “Select CH.”)
17. With the jog shuttle, move the cursor to the bit to which you wish to set the condition.
18. Press the **SELECT** key to select “H,” “L,” or “X.”

Other settings

19. You must also set the following parameters: trigger mode, trigger level, trigger hysteresis, and holdoff time. For information about how to set these parameters, refer to Sections 6.1 to 6.7.

Note

Status settings for conditions A and B apply in common to all trigger types.

6.10 Setting the A Delay B Trigger (ENHANCED)

≡ For a description of this function, refer to page 1-8. ≡

Function

This function activates a trigger the 1st time condition B becomes true after condition A has become true and the preset time has elapsed.

Condition A, B settings

- **Status of each channel:Status**

Select from the following.

For Modules Other than Logic Input Module

- H : Above the preset trigger level
- L : Below the preset trigger level
- X : Don't Care

For Logic Input Modules (Condition B cannot be set)

- O : Make the combination of the status*¹ of each bit the trigger condition
- X : Don't Care

*1 The status of each bit is selected from the following.

- H : Above a certain level*²
- L : Below a certain level*²
- X : Don't Care

*2 Varies depending on the logic probe being used as follows.

- 700986 : approx. 1.4 V
- 700987 : 6 V ± 50% (during DC)
- 700987 : 50 V ± 50% (during AC)

- **Condition**

Select from two conditions, as follows.

Enter : Trigger is activated when all channels come to meet selected status.

Exit : Trigger is activated when one (or more) channel moves out of selected status.

Delay time

0 to 1s (The setting resolution is 500 ns)

Other settings

Refer to sections 6.1 to 6.7 for details on how to set the trigger mode, trigger level, trigger hysteresis, and holdoff time.

Note

If you want to activate only one pattern trigger, use the A/EB(n) trigger function (refer to page 6-10).

Operating Procedure

Setting the trigger type

1. Press the **ENHANCED** key.
2. Press the “**Type**” soft key to display the trigger type menu.
3. Keep pressing the “**Type**” soft key to select “**A Delay B**”.

Setting the condition A

4. Press the “Set Pattern” soft key to display the A Delay B trigger setting menu.
5. Turn the jog shuttle to move the cursor to the <Parallel A> “Condition”.
6. Press the **SELECT** key to display the <Parallel A> “Condition” menu.
7. Press the **SELECT** key again to select “Enter” or “Exit”.

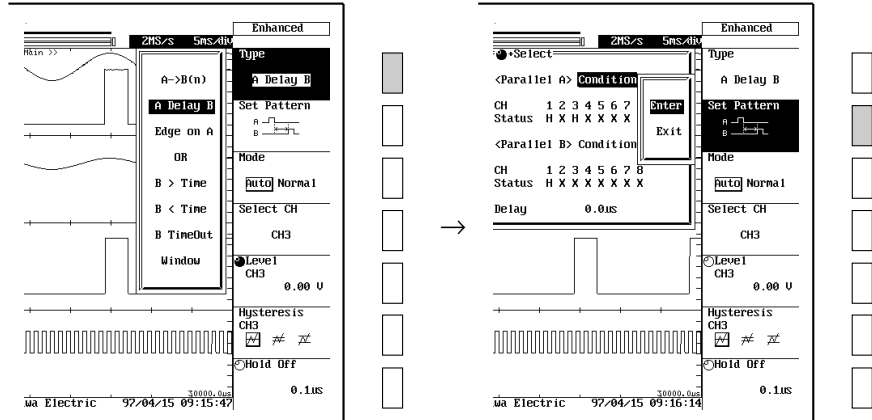

When the channel is a Logic Input Module

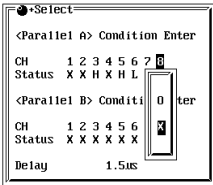

Setting the channel status for condition A

8. Turn the jog shuttle to move the cursor to “CH1” under <Parallel A>.
9. Press the **SELECT** key to display the <Parallel A> CH1 menu.
10. Press the same **SELECT** key the appropriate number of times to select from “H,” “L” and “X” (“O” and “X” for logic input).
11. Repeat the above steps to set the channel status for CH2 to CH8.

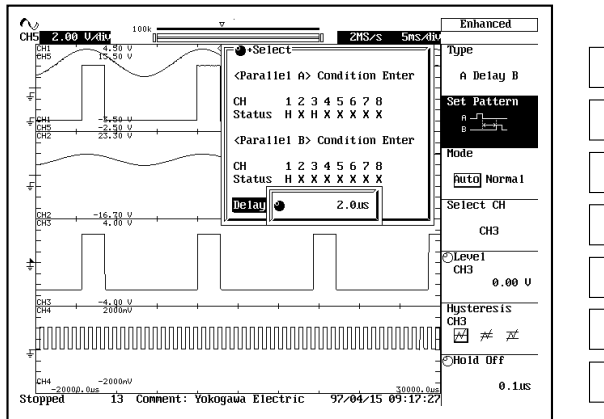

Setting the condition B and channel status

12. Repeat steps 5 to 11 to set the condition B and channel status.

Setting the delay time

13. Turn the jog shuttle to move the cursor to “Delay”.
14. Press the **SELECT** key to display the “Delay” menu.
15. Turn the jog shuttle to set the desired delay time.

You can change the value of the digit using the cursor key (located below the jog shuttle). Pressing the **RESET** key, resets the delay time to “0s”.

Setting the status of each bit on the logic input channel

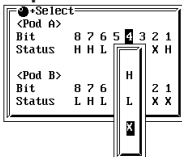

Setting the conditions of POD A and B (when using the logic input channel only)

16. Press the “Bit Pattern” soft key. (This key is not displayed unless logic input channel is selected with “Select CH.”)
17. With the jog shuttle, move the cursor to the bit to which you wish to set the condition.
18. Press the **SELECT** key to select “H,” “L,” or “X.”

Other settings

19. You must also set the following parameters: trigger mode, trigger level, trigger hysteresis, and holdoff time. For information about how to set these parameters, refer to Sections 6.1 to 6.7.

Note

Status settings for conditions A and B apply in common to all trigger types.

6.11 Setting the Edge on A Trigger (ENHANCED)

≡ For a description of this function, refer to page 1-8. ≡

Function

This function activates a trigger when an OR trigger (an edge trigger) occurs while condition A is true.

Condition A, B settings

- **Status of each channel:Status**

Select from the following.

For Modules Other than Logic Input Module

H : Above the preset trigger level

L : Below the preset trigger level

X : Don't Care

For Logic Input Modules

O : Make the combination of the status*¹ of each bit the trigger condition

X : Don't Care

*1 The status of each bit is selected from the following.

H : Above a certain level*²

L : Below a certain level*²

X : Don't Care

*2 Varies depending on the logic probe being used as follows.

700986 : approx. 1.4 V

700987 : 6 V ± 50% (during DC)

700987 : 50 V ± 50% (during AC)

- **Condition A**

Select from two conditions, as follows.

True : All channels are in specified status.

False : At least one channel is not in specified status.

Channel edge-trigger settings

This setting is available only if the channel's condition-A status setting is "X" ("don't care"). If you set all condition-A status settings to "X", the trigger will operate as an OR trigger.

↗ : Rising

↘ : Falling

– : Don't care

The channel that has the logic input module installed cannot set edge triggers.

Other settings

Refer to sections 6.1 to 6.7 for details on how to set the trigger mode, trigger level, trigger hysteresis, and holdoff time.

Operating Procedure

Setting the trigger type

1. Press the **ENHANCED** key.
2. Press the "**Type**" soft key to display the trigger type menu.
3. Keep pressing the "**Type**" soft key to select "**Edge on A**".

Setting condition A to true/false

4. Press the “Set Pattern” soft key to display the Edge on A trigger setting menu.
5. Turn the jog shuttle to move the cursor to the <Parallel A> “Condition.”
6. Press the **SELECT** key to display the <Parallel A> “Condition” menu.
7. Press the **SELECT** key again to select “True” or “False.”

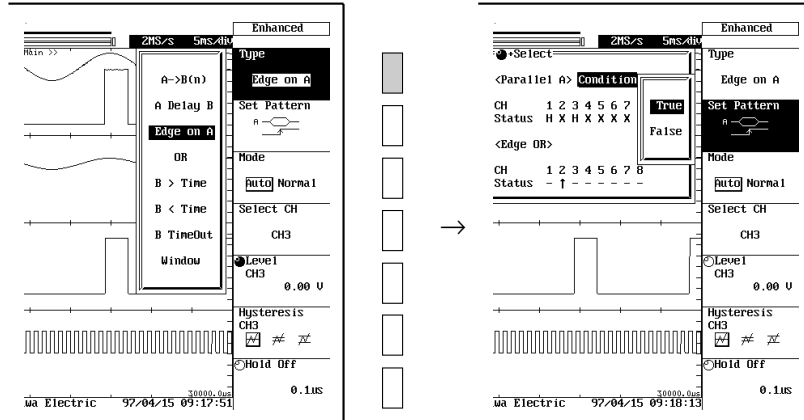

When the channel is a Logic Input Module

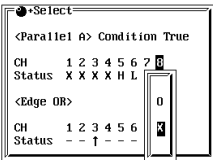

Setting the channel status for condition A

8. Turn the jog shuttle to move the cursor to “CH1” under <Parallel A>.
9. Press the **SELECT** key to display the <Parallel A> CH1 menu.
10. Press the same **SELECT** key the appropriate number of times to select from “H,” “L” and “X” (“O” and “X” for logic input).
11. Repeat the above steps to set the channel status for CH2 to Ext.

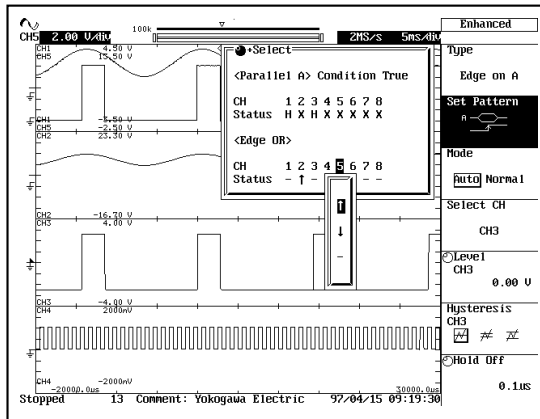

Setting edge OR

12. Turn the jog shuttle to move the cursor to “CH1” under <Edge OR>.
13. Press the **SELECT** key to display the CH1 menu.
14. Press the **SELECT** key again to select “↑,” “↓” or “-.”

Setting the status of each bit on the logic input channel

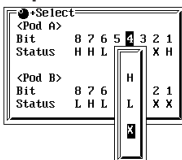

Setting the conditions of POD A and B (when using the logic input channel only)

15. Press the “Bit Pattern” soft key. (This key is not displayed unless logic input channel is selected with “Select CH.”)
16. With the jog shuttle, move the cursor to the bit to which you wish to set the condition.
17. Press the **SELECT** key to select “H,” “L,” or “X.”

Other settings

18. You must also set the following parameters: trigger mode, trigger level, trigger hysteresis, and holdoff time. For information about how to set these parameters, refer to Sections 6.1 to 6.7.

Note

Status settings for condition A apply in common to all trigger types.

6.12 Setting the OR Trigger (ENHANCED)

≡ For a description of this function, refer to page 1-8. ≡

Function

This function activates a trigger when either of the selected edge triggers occurs. For example, a trigger can be caused on either the rising edge of CH1 or CH2.

Edge OR

Select from the following.

↑ : Rising

↓ : Falling

- : Don't care

Note when using the OR trigger

The OR trigger cannot be used on channels which have logic input modules installed.

Other settings

Refer to sections 6.1 to 6.8 for details on how to set the trigger mode, trigger level, trigger hysteresis, and holdoff time.

Note

An OR trigger is identical to the one which is activated when condition A is set to "X" (Don't Care) for all channels in an Edge on A trigger setting.

Operating Procedure

Setting the trigger type

1. Press the **ENHANCED** key.
2. Press the **Type** soft key to display the trigger type menu.
3. Keep pressing the **Type** soft key to select **OR.**

Setting edge OR

4. Press the **Set Pattern** soft key to display the OR trigger setting menu.
5. Turn the jog shuttle to move the cursor to **CH1** under **<Edge OR>**.
6. Press the **SELECT** key to display the **<Edge OR> CH1** menu.
7. Press the **SELECT** key again to select **↑**, **↓** or **-**.
8. Repeat the above steps to set the edge OR for CH2 to Ext.

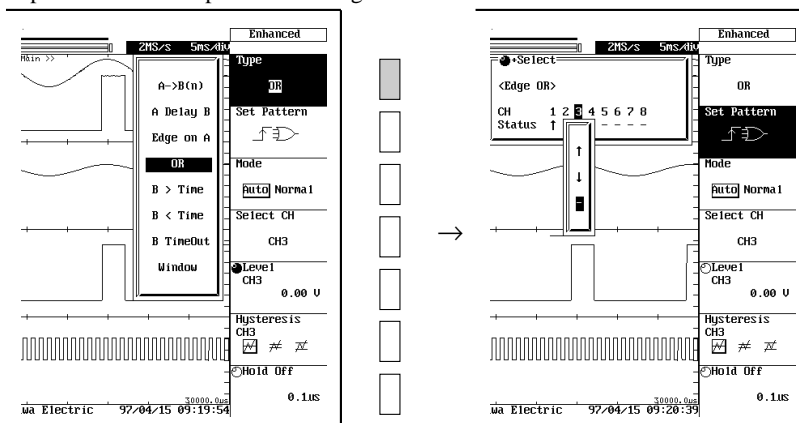

Other settings

9. You must also set the following parameters: trigger mode, trigger level, trigger hysteresis, and holdoff time. For information about how to set these parameters, refer to Sections 6.1 to 6.7.

6.13 Setting the B>Time, B<Time or B Time Out Trigger (ENHANCED)

≡ For a description of this function, refer to page 1-9. ≡

Function

- B>Time : Trigger occurs when condition B goes false after holding true for the preset pulse width.
- B<Time : Trigger occurs when condition B goes false after holding true for less than the preset pulse width.
- B TimeOut : Trigger occurs when condition B has held true for the preset pulse width.

When B > Time, CH1 = H, Time = 4 μ s

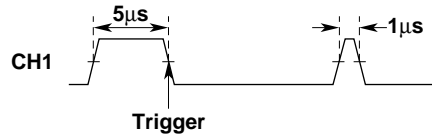

When B Time Out, CH1 = H, Time = 4 μ s

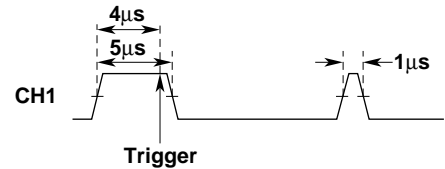

B<Time setup example

When B < Time, pattern B : CH1 = H , CH2 = H , Time = 4 μ s

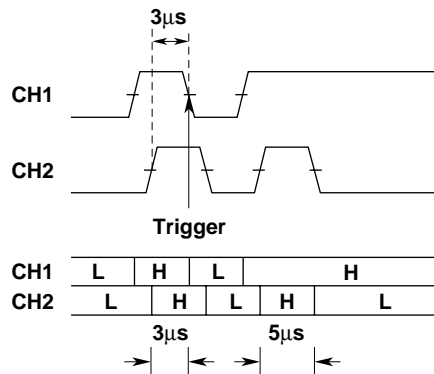

Channel H/L status for condition B

Same as for A \rightarrow B(n) trigger (H/L/X). For details refer to page 6-10.

Channel to use for condition B: Source

There is a limit on the number of channels that can set the trigger condition. Only the conditions on the selected channels are effective. Select from the following.

- CH1 to CH4
- CH5 to CH8

The channel that has the logic input module installed cannot set condition B.

Pulse width

B>Time, B Time Out : 200 ns to 1 s (The setting resolution is 100 ns)

B<Time : 200 ns to 1 s (The setting resolution is 100 ns)

B>Time, B<Time and B TimeOut setting precaution

- Correct operation is not guaranteed if adjacent pulses are less than 200 ns apart or if pulse width is less than 200 ns (typical).

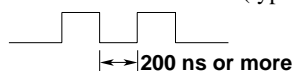

- The B>Time, B<Time and B TimeOut trigger cannot be used on channels which have logic input modules installed.

Other settings

Refer to sections 6.1 to 6.7 for details on how to set the trigger mode, trigger level, coupling, HF rejection, and holdoff time.

Operating Procedure

Setting the trigger type

1. Press the **ENHANCED** key.
2. Press the **“Type”** soft key to display the trigger type menu.
3. Keep pressing the **“Type”** soft key to select **“B>Time,”** **“B<Time,”** or **“B Time Out.”**

Setting the channel status for condition B

4. Press the **“Set Pattern”** soft key to display the pulse width trigger setting menu.
5. Turn the jog shuttle to move the cursor to **“CH1”** under **<Parallel B>**.
6. Press the **SELECT** key to display the **<Parallel A> CH1** menu.
7. Press the **SELECT** key again to select **“H,”** **“L,”** or **“X.”**
8. Repeat the above steps to set the channel status for CH2 to Ext.

Selecting the channels to use for condition B

9. Turn the jog shuttle to move the cursor to **“Source.”**
10. Press the **SELECT** key to select **“CH1~4”** or **“CH5~8.”**

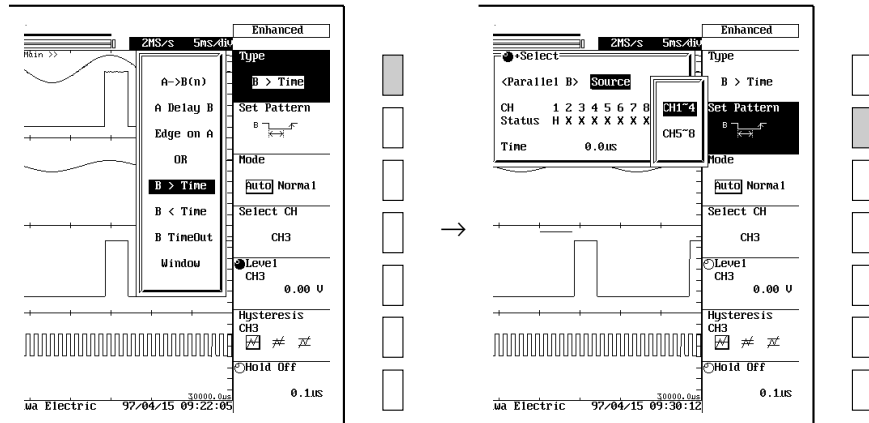

Setting the pulse width

11. Turn the jog shuttle to move the cursor to the **“Time”**.
12. Press the **SELECT** key to display the **“Time”** menu.
13. Turn the jog shuttle to set the desired pulse width.
 You can change the value of the digit using the cursor key (located below the jog shuttle). Pressing the **SHIFT** key, then turning the jog shuttle resets the pulse width to 0.2 μs.

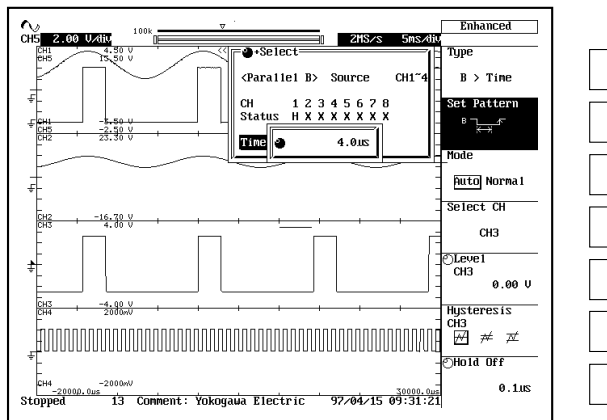

Other settings

14. You must also set the following parameters: trigger mode, trigger level, trigger hysteresis, and holdoff time. For information about how to set these parameters, refer to Sections 6.1 to 6.7.

Note

Status settings for condition B apply in common to all trigger types.

6.14 Setting the Window Trigger (ENHANCED)

≡ For a description of this function, refer to page 1-9. ≡

Function

Waveform for window trigger

Select the waveform to set the window trigger from the following.
CH1 to CH8

Trigger condition

You can set trigger conditions on all channels. The trigger occurs when at least one of the trigger conditions is met (OR condition).*

* The OR trigger is available on DL708Es with firmware versions 4.00 or later.

⇌*: Trigger occurs when the trigger source enters the window (the area between two preset levels).

⇋*: Trigger occurs when the trigger source exits the window.

— : No trigger condition is set.

* This is the display when the firmware version of the DL708E is 4.00 or later. For DL708Es of earlier versions, "IN" and "OUT" are displayed as "⇌" and "⇋," respectively.

Window setting

You define the window by its center level and width.

"Center" setting range : Anywhere within the 8 screen divisions, in resolution of 0.1 div.

(Example: If the scale is 1 V/div, resolution is 0.1 V).

"Width" setting range : Up to ± 5 div from center, in resolution of 0.2 div. (Example: If the scale is 1 V/div, resolution is 0.2 V).

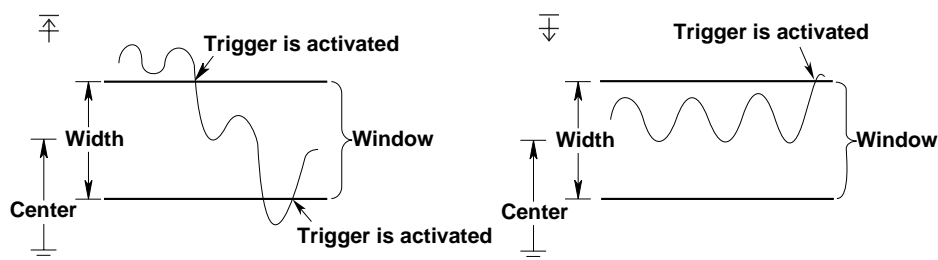

Other settings

Refer to sections 6.1 to 6.7 for details on how to set the trigger mode, trigger level, coupling, HF rejection, and holdoff time.

Note when using the Window trigger

The Window trigger cannot be used on channels which have logic input modules installed.

Note

If you set the window so that the top or bottom is off the screen, the trigger will occur at the level for the corresponding screen edge (the level at ± 4 divisions from screen center) rather than at the "missing" top or bottom.

Operating Procedure

Set the trigger type

1. Press the **ENHANCED** key.
2. Press the “**Type**” soft key to open the Trigger Type menu.
3. Press the “**Type**” soft key as necessary to select Window.

Set the trigger condition

4. Press the “**Set Pattern**” soft key to open the trigger condition menu.
5. Turn the jog shuttle and move the cursor to CH“1” of <Window OR>.
6. Press the **SELECT** key to display the CH“1” menu of <Window OR>.
7. Press the same **SELECT** key several times to select “ \overline{A} ,” “ $\overline{A} \downarrow$,” or “—.”

Select the waveform

8. Press the “**Select CH**” soft key to select the desired waveform from channels “CH1” to “CH8.”

Set the window center

9. Press the “**Center/Window Width**” soft key as necessary to set the jog shuttle action to “Center.”
10. Turn the jog shuttle to set the center level.

Set the width

11. Press the “**Center/Window Width**” soft key as necessary to set the jog shuttle action to “Window Width.”
12. Turn the jog shuttle to set the width.

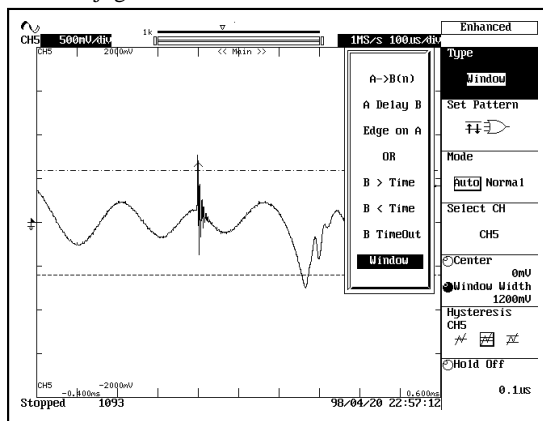

Other settings

13. You must also set the following parameters: trigger mode, trigger hysteresis and holdoff time. For information about how to set these parameters, refer to Sections 6.1 to 6.7.

* The above procedures are for DL708Es with firmware versions 4.00 or later. For DL708Es of earlier versions, follow the procedures below.

Procedure

1→2→3→8→ Set the trigger condition (see below) →9→10→11→12→13

Set the trigger condition

Press the “**Condition**” soft key to select “IN” or “OUT.”

6.15 Setting the Timer Trigger

(A function on DL708Es with firmware versions 4.00 or later)

Function

The trigger is activated at specified time intervals from the specified time. The following time intervals are selectable.

1min, 2min, 3min, 4min, 5min, 6min, 7min, 8min, 9min, 10min, 15min, 20min, 25min, 30min, 40min, 45min, 50min, 1h, 2h, 3h, 4h, 5h, 6h, 7h, 8h, 9h, 10h, 11h, 12h, 18h, 24h

Trigger position

As in the normal trigger, you can set the trigger position to observe the phenomenon occurring around the specified time. Initially, the trigger position is set to 50% and positioned at the center of the screen. To observe only the waveform after the trigger set the trigger position to 0%. To observe only the waveform before the trigger set it to 100%.

Notes on Timer Trigger

- Depending on the time interval setting, a trigger may occur while the waveform is being acquired or during the pre-trigger period (a preparation period for observing the waveform before the trigger time). In this case, the trigger is ignored.
- If the trigger time is set to a time in the past, the trigger is activated when the current time becomes:
Specified time + time interval \times N (where N is an integer).
- If you specify the acquisition count, the waveforms are acquired the specified number of times. If it is set to Infinite, the waveforms are acquired until the **STOP** key is pressed. For setting the acquisition count, see page 7-3.
- You can save the waveform to the internal hard disk or external media, make a hard copy, and do other operations by using the action on trigger function.

Operating Procedure

1. Press the **SIMPLE** key.
2. Press the **Mode** key several times to select **Time**.
3. Press the **Date** soft key to display the keyboard.
4. Set the date on which to activate the trigger according to the procedure for entering a string as described on page 4-2.
5. Similarly, press the **Time** soft key to set the time.
6. Press the **Time Interval** soft key to set the jog shuttle action to **Time Interval**.
7. Turn the jog shuttle to set the trigger time interval.

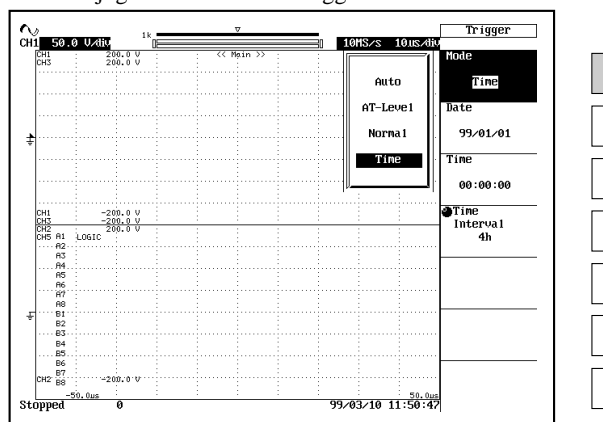

Note

The present date/time can be entered by pressing the **RESET** key while setting the date/time.

7.1 Setting the Record Length

≡ For a description of this function, refer to page 1-12. ≡

Function

The record length sets the amount of data to be written into the acquisition memory. Maximum length depends upon the machine model. Available length settings are as follows.

4M/CH models : 1 k, 10 k, 40 k, 100 k, 200 k, 400 k, 1 M, 2 M, 4 M, 8 M^{*2}, 16 M^{*1}

2M/CH models : 1 k, 10 k, 40 k, 100 k, 200 k, 400 k, 1 M, 2 M, 4 M^{*2}, 8 M^{*1}

1M/CH models : 1 k, 10 k, 40 k, 100 k, 200 k, 400 k, 1 M, 2 M^{*2}, 4 M^{*1}

100k/CH models : 1 k, 10 k, 40 k, 100 k, 200 k^{*2}, 400 k^{*1}

*1 Selecting this record length limits the channels that can be used to CH1 and CH5.

*2 Selecting this record length limits the channels that can be used to CH1, CH3, CH5 and CH7.

Setting precautions

- Increasing the record length automatically limits the number of channels that can be used. The display of the channels which can no longer be used because the record length is increased can not be turned ON/OFF.

The number of channels that can be used is displayed on the soft key menu of “Record Length.” The channels that can be used are as follows.

Record Length(8CH) : CH1 to CH8 can be used

Record Length(4CH) : CH1, CH3, CH5 and CH7 can be used

Record Length(2CH) : CH1 and CH5 can be used

- Sampling rate and displayed record length vary according to the T/div setting. For details, see Appendix 1.
- If the maximum acquisition count is set to 1 (refer to the appendix 2), a signal may not be captured with the assigned full record length depending on timing of acquisition Stop. In order to capture a signal with full record length, use “Single Start” or “Log Start.”

Operating Procedure

- Press the **ACQ** key.
- Press the “**Record Length**” soft key to set the jog shuttle action to Record Length.
- Select the length by turning the jog shuttle.

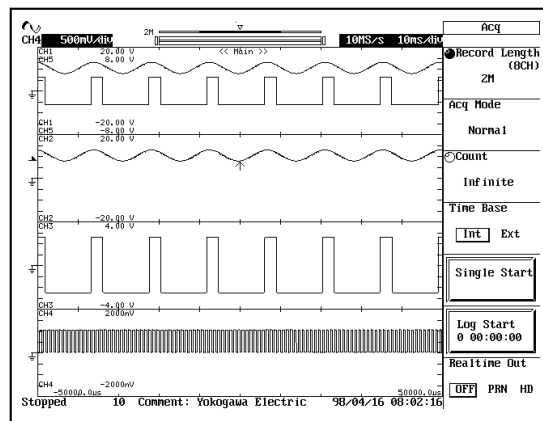

Number of channels that can be used.



7.2 Acquisition Mode

≡ For a description of this function, refer to page 1-12. ≡

Function

You can select any of five acquisition modes, as follows. The default selection is Normal.

Normal

The instrument writes sample data into acquisition memory without performing special processing.

Average

The instrument calculates average values and writes these into the acquisition memory. If the acquisition count is set to Infinite, the instrument uses exponential averaging, and you are required to set a Weight value. If the count is set to a numerical value (from 2 to 65536), the instrument calculates simple averages using the specified number of readings.

Exponential averaging(count=Infinite)

$$A_n = \frac{1}{N} \{(N-1)A_{n-1} + X_n\}$$

A_n : Value obtained after nth averaging

X_n : nth measured value

N : Attenuation constant
(2 to 256, in steps of 2ⁿ)

Linear averaging(count=2 to 65536)

$$A_N = \frac{\sum_{n=1}^N X_n}{N}$$

X_n : nth measured value

N : Number of averaging times
(Acquisition count,
in steps of 2ⁿ)

• Setting restrictions

- If 4MW/CH model : You cannot select this mode if the record length is set to 1 M or higher.
- If 2MW/CH model : You cannot select this mode if the record length is set to 400 k or higher.
- If 1MW/CH model : You cannot select this mode if the record length is set to 200 k or higher.
- If 100kW/CH model : You cannot select this mode if the record length is set to 40 k or higher.

For details on the maximum record length that allows roll mode and averaging, refer to Appendix 1 “Relationship between the Time Axis Setting, Sample Rate and Record Length” and Appendix 2 “Relationship between the Record Length and Acquisition Mode.”

Sequence (Sequential store)

For details, see Section 7.3.

Envelope

The instrument finds the maximum and minimum values from the data sampled at the maximum sample rate of each module, writes these values into acquisition memory, and generates an “envelope” waveform showing max/min levels for each point.

• Setting restriction

The setting is valid when the sample rate is 5 MS/s or less.

BoxAverage

For details, see Section 7.4.

Acquisition count

The available count settings are indicated below. If you set the value to Infinite, acquisition will continue until you switch it off with the **START/STOP** key.

The default count is Infinite.

- Normal, Envelope, or BoxAverage mode:
2 to 65535 (in steps of 1), Infinite
- Average mode:
2 to 65536 (in 2ⁿ steps), Infinite
- Sequence mode:
(See Section 7.3.)

Important information about the averaging mode

- Averaging mode is useful when working with repetitive waveforms.
- Correct averaging is not possible if the waveform has imperfect triggering, since synchronization will be poor and the displayed waveform will be distorted. When working with this type of signal, set the trigger mode to Normal, so that the waveform display is updated only when the trigger occurs. (See page 6.1.)
- Roll mode display is disabled during averaging.
- For linear averaging, the waveform is acquired in normal mode regardless of the trigger mode setting. If no trigger occurs, the linear average waveform is not displayed.
- If you stop waveform acquisition by pressing the **START/STOP** key, the averaging process also stops. Averaging restarts from the beginning when acquisition resumes.
- Single start and log start (see page 4-6) cannot be used in averaging mode.
- If you are using simple averaging, the instrument terminates acquisition automatically when it completes the specified number of acquisitions (as set by the acquisition count).
- Averaging cannot be done on a channel that has the logic input module installed.

Operating Procedure**Set the acquisition mode**

1. Press the **ACQ** key.
2. Press the “**Acq Mode**” soft key as necessary to select the mode. Some modes are not available with certain record lengths and sampling rates.

Set the acquisition count

3. Press the “**Count**” soft key, so that the jog shuttle action is set to “**Count.**”
4. Set the count by turning the jog shuttle. You can use the arrow keys to move to different columns within the value. You can set the value to Infinite by pressing the **RESET** key. If you have set the mode to Average and the count to Infinite, you must now proceed to set the weight, as described below.

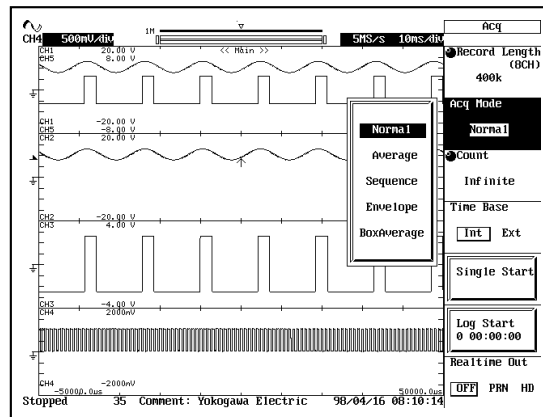
**Set the weight (Only if mode is Average and count is Infinite.)**

5. Press the “**Weight**” soft key, so that the jog shuttle action is set to “**Weight.**”
6. Turn the jog shuttle to set the value.

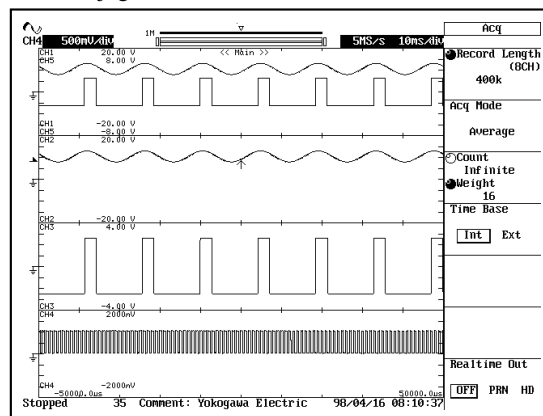

7.3 Sequential Store Mode

≡ For a description of this function, refer to page 1-13. ≡

Function

Acquisition count

Available numerical settings are as follows.

If you set the value to Infinite, acquisition will continue until you switch it off with the **START/STOP** key.

Infinite, 2 to 1000

However, the count number that can be selected varies depending on the selected record length and acquisition mode.

For details, refer to Appendix 2 “Relationship between the Record Length and Acquisition Mode.”

Waveform display method

You can recall waveforms from memory in the same way as you do when working with the history function. For details, refer to Section 7.5, “Using the History Memory.”

Restrictions and precautions

- You can not use this mode together with the roll mode.
- If you stop waveform acquisition by pressing the **START/STOP** key, sequential storage also stops. It then restarts again from the beginning when acquisition resumes.
- The waveform is acquired in normal mode regardless of the trigger mode setting. If no trigger occurs, sequential store does not finish.
- If the acquisition count is set to “Infinite,” it operates in the same way as the normal waveform acquisition (normal mode).

Operating Procedure

Set the acquisition mode to sequential store

1. Press the **ACQ** key.
2. Press the “**Acq Mode**” soft key to open the acquisition-mode menu.
3. Press the “**Acq Mode**” soft key as necessary to select Sequence.

Set the acquisition count

4. Press the “**Count**” soft key, so that the jog shuttle action is set to “**Count**.”
5. Set the count by turning the jog shuttle.

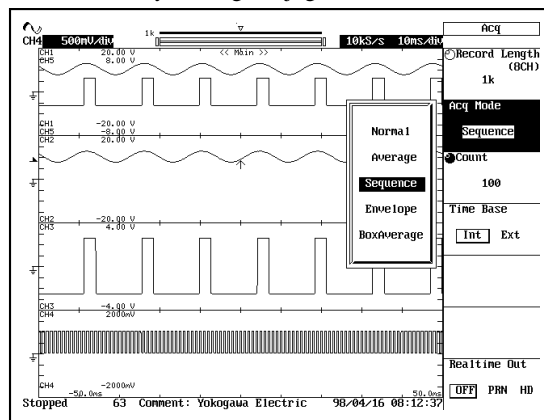

7.4 Box Average Mode

(For High-Speed Isolation/High-Speed Modules)

≡ For a description of this function, refer to page 1-13. ≡

Function

Under normal conditions, the instrument constantly samples the input signal at 10 MS/s, extracts values according to the T/div setting from the sampled data, and writes to the acquisition memory.

However, when using the box average function, the sampling data is not extracted. Instead, the moving average values of a certain number of data points are written to the acquisition memory as shown in the following figure.

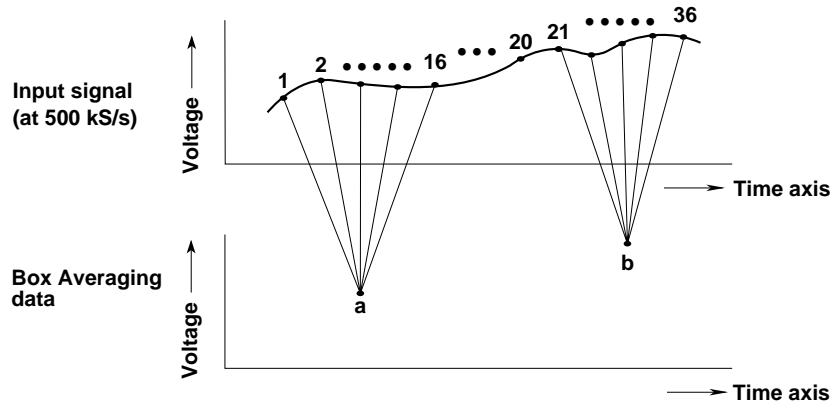

Effects of Box Averaging

| Sample rate (S/s) | Data point | Resolution Enhancement by the moving average*2 $m = 0.5 \times \log_2(N)$ (bits) |
|-------------------|---|---|
| 10 M*1 | 1 | 0.0 |
| 5 M | 2 | 0.5 |
| 2 M | First 4 of every 5 samples | 1.0 |
| 1 M | First 8 of every 10 samples | 1.5 |
| 500 k | First 16 of every 20 samples | 2.0 |
| 200 k | First 32 of every 50 samples | 2.5 |
| 100 k | First 64 of every 100 samples | 3.0 |
| 50 k | First 128 of every 200 samples | 3.5 |
| 20 k | First 256 of every 500 samples | 4.0 |
| 10 k or less | First 256 of every (10 M ÷ sample rate) samples | 4.0 |

*1 Operates in the same way as normal mode.

*2 Effects of lowered noise resulting from the moving average : $1/\sqrt{N}$

Assuming that the resolution enhances by one bit every time the noise level is halved, we can generalize the relation between N and the resolution enhancement as:

$$1/\sqrt{N} = 1/2^m$$

where, m is the number of bits of enhanced resolution when the number of data points used to compute the moving average is N.

Thus

$$m = \log_2(\sqrt{N}) = 0.5 \times \log_2(N)$$

Operating Procedure

1. Press the **ACQ** key.
2. Press the “**Acq Mode**” soft as necessary to select BoxAverage.

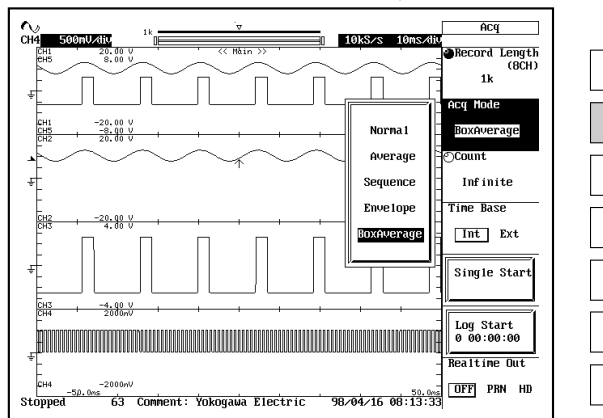

7.5 Using the History Memory

≡ For a description of this function, refer to page 1-14. ≡

Function

The acquisition memory retains waveform records generated by the most recent triggers. The number of stored records is equivalent to the maximum number of records that can be obtained when using sequential-store mode. Once the history becomes full, each new trigger causes loss of the oldest waveform record in the memory.

Selected Record No.

You can display any waveform from the history by entering its record number. The newest (current) waveform is Record 0, the immediately previous waveform is Record -1, and so on. The range for Selected Record No. is therefore [0 to -(retained waveforms - 1)]. The number of triggers that can be retained varies depending on the selected record length and acquisition mode.

For details, refer to Appendix 2 "Relationship between the Record Length and Acquisition Mode."

Display

- Set to One to display the selected record only.
- Set to All to generate overlapped display of all history records from the Start Record No. to the End Record No. The waveform corresponding to the Selected Record No. will appear brighter than the other waveforms.

Show Map (List of time stamps)

You can list the numbers of the waveform data acquired in the acquisition memory and the times of completion of the data acquisitions. The record number is displayed in 4 digits (record number 0, -1, -2 are displayed as 0000, 0001, 0002, respectively).

Each page of the list shows information for 100 records. You use the Show Map No. setting to select the page (map) to appear on the screen.

Precautions and Restrictions

- You cannot use the history function while the acquisition mode is set to Average. (Displayed history records will be meaningless.)
- If you suspend waveform acquisition before the current record has been fully read, the record will not be recorded in the history.
- You cannot use the history function together with the accumulation function.
- History records are not lost when waveform acquisition is stopped and then restarted, provided that acquisition conditions remain unchanged.
- If you change the acquisition settings, history memory is cleared when you restart acquisition using the new settings.

Precautions to be taken when recalling data from the history memory

- Acquisition will stop when the history memory menu is displayed. It is not possible to recall waveform data from the history memory while acquisition is in progress.
- Acquisition can be restarted while the history memory menu is displayed. However, it is not possible to change history memory settings such as “Selected Record No.”, while acquisition is in progress.
- When “Display All” has been selected, settings are restricted by the following formula.
End Record No. \leq Selected Record No. \leq Start Record No.
- If you load a waveform record from floppy disk, internal hard disk, or external storage device, the loaded waveform becomes Record 0. In the case of multiple records (accumulation, sequential store), the records will be loaded sequentially, with the latest record as “0”.
- Computation and automatic measurement of waveform parameters are always performed on the currently displayed waveform, i.e. the waveform identified by the record No. designated for “Selected Record No.”. Analysis of old data is possible as long as the history memory content remains unchanged after acquisition is restarted.
- The time indicated in the Show Map is the time when the waveform data acquisition ended. However, for waveforms that are loaded from a floppy disk, only the “hour, minute, second” are displayed and the rest are set to 00 (example: 12:34:56 00).
- Turning OFF the power will delete the entire contents of the history memory.
- The data that is realtime recorded to the internal hard disk (optional) cannot use the history function.

Operating Procedure

Recalling data from the history memory

1. Press the **HISTORY** key.
2. Press the **“Selected Record No.”** soft key.
The **“Selected Record No.”** can now be set using the jog shuttle.
3. Turn the jog shuttle to set the desired record No.
4. Press the **“Display”** soft key to select either **“One”** or **“All”**.
Proceed to step 5 if **“All”** is selected, or to step 8 if **“One”** is selected.

Setting the accumulation range (when **“All”** has been selected)

5. Press the **“Start Record No.”** soft key.
The **“Start Record No.”** can now be set using the jog shuttle.
6. Turn the jog shuttle to set the desired start record No.
7. Set the **“End Record No.”** as well.

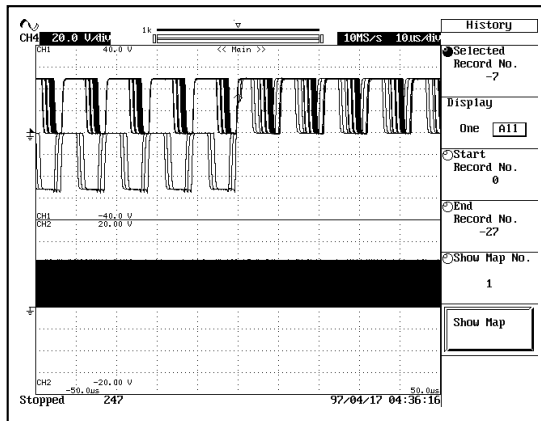

Displaying the time-stamp lists

8. Pressing the **“Show Map”** soft key displays a list of numbers of the acquired waveform data and the times when the waveform data acquisitions ended.
9. Press the **“Show Map No.”** soft key to set the jog shuttle action to map selection.
10. Turn the jog shuttle to select the desired map (page). The listing on the screen changes accordingly.

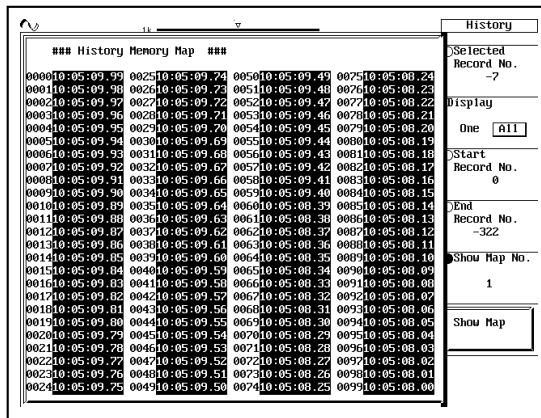

7.6 Realtime Print to the Built-in Printer

≡ For a description of this function, refer to page 1-14. ≡

Function

The waveform (screen image data) is continuously printed to the built-in printer like a recorder.

Waveform to realtime print

All of the original waveforms displayed on the screen are realtime printed. If only the X-Y waveform/zoom waveform is displayed (the original waveform is not displayed), then realtime printing cannot be performed.

Valid time axis setting for realtime print and the paper feeding speed (chart speed)

The time axis setting that allows for realtime print is between 500 ms/div and 100 ks/div with the sample rate of 100 kS/s or less. For 500 ms/div, a 200 kS/s sample rate is also possible. The sample rate varies according to the record length even with the same T/div setting. For details, refer to Appendix 1 “Relationship between the Time Axis Setting, Sample Rate and Record Length.” In addition, the chart speed is automatically determined according to the time axis setting as follows.

| T/div | Chart speed |
|------------|--------------|
| 500 ms/div | 20 mm/s |
| 1 s/div | 10 mm/s |
| 2 s/div | 5 mm/s |
| 5 s/div | 2 mm/s |
| 10 s/div | 1 mm/s |
| 20 s/div | 0.5 mm/s |
| : | : |
| 100 ks/div | 0.006 mm/min |

Chart speed = 10 mm ÷ (number of seconds in 1 div on the time axis)

Example The chart speed for 50 s/div is 10 mm ÷ 50 s = 0.2 mm/s

Record time

Realtime print is carried out for the specified amount of time. The time is selected at the time of execution with the **START/STOP** key. The following record length can be selected. Continuous (continue printing until the acquisition is stopped with the **START/STOP** key), 10s, 20s, 30s, 40s, 50s, 1 min to 9 min, 10 min to 50 min, 1 hour to 6 hour, 12 hour, 1 day to 10 day

The record time that can be selected varies depending on the record length and the time axis setting. The time displayed on the lower part of the “Log Start” soft key menu is the upper limit of the available record times. If the desired time cannot be selected, you can do the following.

- Decrease the sample rate with the T/div knob
- Set the record length to 1M or more

Setting the record length for realtime print : Record length

Prints the specified record length of data in realtime. This is specified before executing with the “Log Start” soft key in the **ACQ** menu.

The time corresponding to the set record length is displayed at the lower part of the “Log Start” soft key (for example, 3 12:34:56 is 3 days and 12 hours 34 minutes 56 seconds).

The record length that can be specified varies according to the T/div setting or the memory option. For details, refer to Appendix 1 “Relationship between the Time Axis Setting, Sample Rate and Record Length.”

Starting the realtime print

Following methods can be used to start the realtime print.

- Pressing the **START/STOP** key initiates the print. After printing for the set time, the printing stops.
- Pressing the “Log Start” soft key initiates the print. After printing for the set record length, the printing stops.

Stopping the realtime print

If the waveform acquisition is stopped by pressing the **START/STOP** key, the print out is also stopped even if it is within the set record time.

Points to note when realtime printing

- When the acquisition mode is set to average or sequential store, realtime print cannot be executed.
- During the realtime print, starting and stopping the print are the only valid actions.
- Cursor measurements and automatic measurement of waveform parameters are suspended.
- During realtime printing, history memory waveform/X-Y display waveform/recalled waveform/zoom waveform/computed waveform cannot be displayed.
- An error message is displayed, if the paper runs out during the realtime print.
- Irrespective of the interpolation method, line interpolation (refer to page 8-2) is used.
- Up to the first three points of data become undefined on the waveform immediately after the start of the realtime printing.

The number of points that become undefined depends on the sample rate.

Operating Procedure

1. Press the **ACQ** key.

Selecting the realtime record destination

2. Press the “**Realtime Out**” soft key to select “**PRN.**”

Setting the record time (when executing with the START/STOP key)

3. Press the “**Record Time**” soft key to set the jog shuttle action to “**Record Time.**”
4. Set the record time with the jog shuttle.

Setting the record length to realtime print (when executing with “Log Start” soft key)

3. Press the “**Record Length**” soft key to associate the jog shuttle to the “**Record Length.**”
4. Set the record length with the jog shuttle.

Executing with START/STOP key

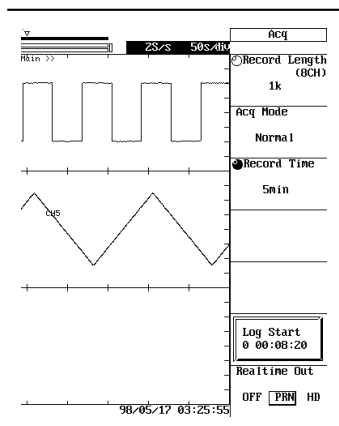

Executing with Log Start soft key

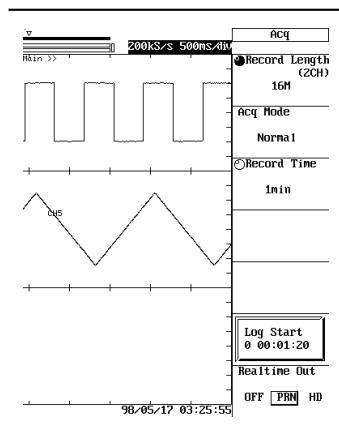

Executing the realtime print

5. Start the waveform acquisition with the **START/STOP** key (can also be started with the “**Log Start**” soft key).

7.7 Realtime Record to the Internal Hard Disk (Optional)

≡ For a description of this function, refer to page 1-14. ≡

Function

The data can be realtime recorded to the internal hard disk (option).

The area for the realtime record is 256 MB. The rest of the area is used to store various data.

Waveform to realtime record

All of the original waveforms displayed on the screen are realtime recorded. If only the X-Y waveform/zoom waveform is displayed (the original waveform is not displayed), then realtime printing cannot be performed.

The possible time axis settings for realtime recording

The time axis setting varies depending on the number of channels to realtime record.

| | |
|----------------------|--|
| 8CH (all channels) | : 10 s/div to 100 ks/div with the sample rate set to 10 kS/s or less 1 MW to 16 MW |
| 4CH (any 4 channels) | : 5 s/div to 100 ks/div with the sample rate set to 20 kS/s or less 1 MW to 32 MW |
| 2CH (any 2 channels) | : 2 s/div to 100 ks/div with the sample rate set to 50 kS/s or less 1 MW to 64 MW |
| 1CH (any 1 channel) | : 1 s/div to 100 ks/div with the sample rate set to 100 kS/s or less 1 MW to 128 MW |

Setting the record time: Record Time

Records to the hard disk for the specified amount of time. This is set before executing with the **START/STOP** key. Record Time can be selected from the following.

Continuous (Continue to record until the waveform acquisition is stopped with the **START/STOP** key), 10 s, 20 s, 30 s, 40 s, 50 s, 1 min to 9 min, 10 min to 50 min, 1 hour to 6 hour, 1 to 10 days.

The record time that can be selected varies depending on the record length and the time axis setting. The time displayed on the lower part of the “Log Start” soft key menu is the upper limit of the available record times. If the desired time cannot be selected, you can do the following.

- Decrease the sample rate with the T/div knob
- Set the record length to 1M or more

Store length

Select the record length from the following choices. Set this parameter when executing with “Log Start” in the **ACQ** menu.

1 MW, 2 MW, 4 MW, 8 MW, 16 MW, 32 MW^{*1}, 64 MW^{*2}, 128 MW^{*3}

The time corresponding to the set record length is displayed at the lower part of the “Log Start” soft key (for example, 3 12:34:56 is 3 days and 12 hours 34 minutes 56 seconds).

*1 Any four channels can be used.

*2 Any two channels can be used.

*3 Any one channel can be used.

Starting the realtime record

Following three methods can be used to start the realtime record.

- Realtime record starts by pressing the **START/STOP** key. After recording for the specified amount of time, it stops.
- Realtime record starts by pressing the “Log Start” soft key in the **ACQ** menu. The data is recorded for the set record length and stops.

Stopping the realtime record

If the waveform acquisition is stopped by pressing the **START/STOP** key, the recording is also stopped even if it is within the set record time.

Backing up the realtime recorded data

You can back up one set of the realtime recorded data to the data save area (see page 1-14) in the internal hard disk. The data that are backed up can be recalled to the real time record area by pressing the “**Restore HD**” soft key.

Note that if the record length is large, backup and recall take time (about 10 minutes for 128 MW).

Saving and loading the realtime recorded waveform data

See section 11.6 “Saving/Loading Waveform Data.”

Points to note when realtime recording

- When the acquisition mode is set to average or sequential store, realtime record cannot be executed.
- During the realtime record, starting and stopping the recording are the only valid actions.
- Because the maximum record length that can be displayed on the screen is 1 MW, if more than 2 MW of data is realtime recorded, move the waveform display position with the “Main Position” soft key of the ZOOM menu to observe the measured data.
- Cursor measurements and automatic measurement of waveform parameters are suspended.
- During realtime printing, history memory waveform/X-Y display waveform/recalled waveform/zoom waveform/computed waveform cannot be displayed.
- The following operations can be carried out on the data which is realtime recorded to the hard disk (history memory function is not available).
Cursor measurements and automatic measurement of waveform parameters, zoomed waveform and computation waveform, X-Y display waveform, loaded waveform, print out
- When realtime recording to the internal hard disk, do not connect the PC to the SCSI connector.
- To save data recorded to the hard disk in realtime, press the **FILE** key and then select “**Save.**” Please refer to Section 11.6, “Saving/Loading Waveform Data,” for details concerning the saving and viewing of realtime recorded waveform data.
- Data that is realtime recorded to the internal hard disk can be backed up to the internal hard disk by pressing the “**Backup HD**” soft key under the **ACQ** key. Pressing the “**Restore HD**” soft key loads the data that was backed up. You can only back up one set of data.
- Up to the first three points of data become undefined on the waveform immediately after the start of the realtime recording.
The number of points that become undefined depends on the sample rate.

Note

Since the data which is realtime recorded to the hard disk is handled in the same way as the data acquired in the acquisition memory, restarting the waveform acquisition or turning OFF the power clears the data. To save the data, refer to Section 11.6 “Saving/Loading Waveform Data” and save the data accordingly.

Operating Procedure

1. Press the **ACQ** key.

Selecting the realtime record destination

2. Press the “**Realtime Out**” soft key to select “**HD.**”

Setting the record time (when executing with the **START/STOP** key)

3. Press the “**Record Time**” soft key to set the jog shuttle action to “**Record Time.**”
4. Set the record time with the jog shuttle.

Setting the record length to realtime print (when executing with “**Log Start**” soft key)

3. Press the “**Store Length**” soft key to associate the jog shuttle to the “**Store Length.**”
4. Set the record length with the jog shuttle.

Executing with **START/STOP** key

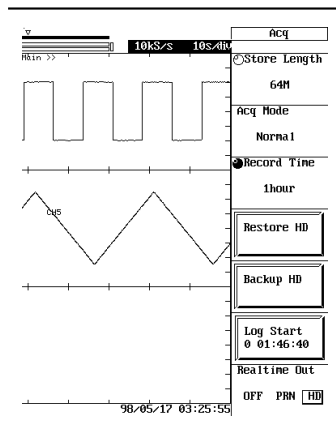

Executing with **Log Start** soft key

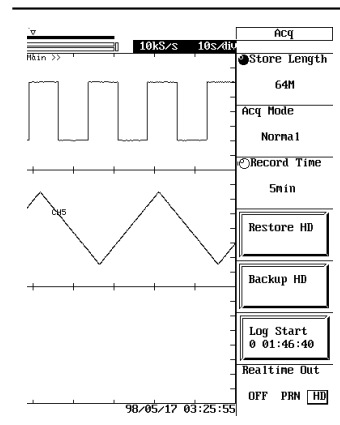

Executing the realtime recording

5. Start the waveform acquisition with the **START/STOP** key (can also be started with the “**Log Start**” soft key).

Backing up/Recalling realtime recorded data

6. After the realtime recording, press the “**Backup HD**” soft key to display the backup menu.
7. Select “**OK**” or “**Cancel**” with the jog shuttle and press the **SELECT** key to confirm. If you select “**OK**,” backup begins.
8. Press the “**Restore HD**” soft key to display the recall menu.
9. Select “**OK**” or “**Cancel**” with the jog shuttle and press the **SELECT** key to confirm. If you select “**OK**,” recall begins.

8.1 Changing the Display Format

Function

Main Format

- Single: 1 waveform window
- Dual : 2 waveform windows
- Triad : 3 waveform windows
- Quad : 4 waveform windows
- Hexa : 6 waveform windows
- Octal : 8 waveform windows

Mapping

- Auto : Windows are arranged from top to bottom in order: CH1, CH2,..., Math1, Math2. But no windows are shown for channels for which display is set OFF.
- Fixed : Channels are displayed regardless of whether display is set ON or OFF, in order of channel number. The Math2 window is at the bottom, with the Math1 window directly above it.
- User : You can assign waveforms arbitrarily to the windows regardless of ON/OFF condition of the display. You can select the display position from numbers 0 to 7. The waveforms are assigned in order from top to bottom starting from number 0.

Auto(If CH7=OFF)

| |
|----------|
| CH1, CH5 |
| CH2, CH6 |
| CH3, CH8 |
| CH4 |

Fixed(If CH7=OFF)

| |
|----------|
| CH1, CH5 |
| CH2, CH6 |
| CH3 |
| CH4, CH8 |

User(Set number 4 to CH2, 1 to Math1, and 0 to Math2, when using 4 waveform windows.)

| | |
|------------|------|
| CH2, Math2 | 0, 4 |
| Math1 | 1, 5 |
| | 2, 6 |
| | 3, 7 |

Displayed in order according to the set numbers.

The number of points that can be displayed vertically for each channel varies as follows according to the display format. However, the vertical resolution remains unchanged.

- Single: 432 points
- Dual : 216 points
- Triad : 144 points
- Quad : 108 points
- Hexa : 72 points
- Octal : 54 points

Operating Procedure

1. Press the **DISPLAY** key.
2. Keep pressing the “Main Format” soft key to select the desired format from “Single” to “Octal.”
3. Press the “Next” soft key, so that it changes to “Next 2/2.”
4. Press the “Mapping” soft key and select one from “Auto” to “User.”

Set the display position (only when “Mapping” is set to “User”)

5. Select the channel/computed waveform with the jog shuttle and the **SELECT** key and set the display position.

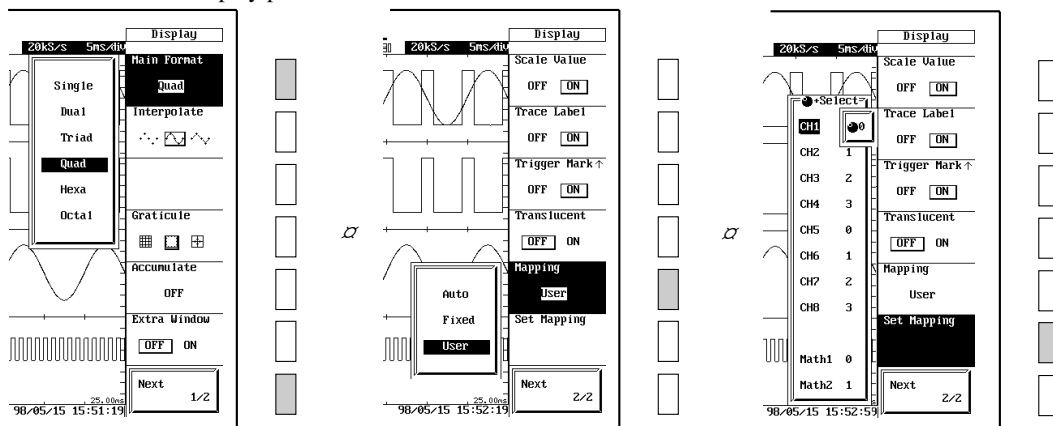

Note

In addition, an extra window is provided to display computed waveforms as well as information other than waveforms, such as automatically measured waveform parameters. For details refer to page 8-7.

8.2 Setting the Interpolation Method

≡ For a description of this function, refer to page 1-16. ≡

Function

Interpolate

Any area along the time axis having less than 500 points per 10 divisions is recognized as an interpolation area. If you leave interpolation off, these points will appear as discrete dots (so that the display will show gaps between dots or vertical lines). If you set interpolation on, however, the instrument will connect the points. Three interpolation settings are available.

Sine() : Interpolates between two dots using a sine curve ($\sin(x)/x$).

Line() : Interpolates between two dots in a straight line.

OFF() : No interpolation

Outside the interpolation area

If interpolation is set to Sine or Line, the instrument draws lines between points that are aligned vertically.

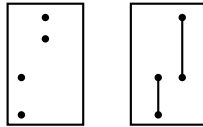

Interpolate : OFF Sine or Line

Within the interpolation area

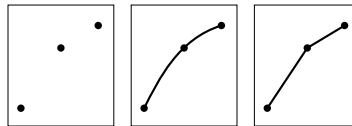

Interpolate : OFF Sine Line

Display Style

Selects the compression method used when interpolation is set OFF.

P-P : Display maximum and minimum data values for each fixed interval.

Decim: Display data value at each fixed interval.

All : Display all data (no compression).

Data interpolation under Envelope mode

If Envelope mode is selected, the instrument uses “area” interpolation as shown below (regardless of the selected Display Style). Since Envelope mode operates by recording maximum and minimum values at each given interval, the instrument cannot determine time positions for data between these intervals.

Operating Procedure

Set the interpolation method

1. Press the **DISPLAY** key.
2. Keep pressing the “**Interpolate**” soft key to select the necessary method.

Set the compression method (Only if Interpolate=OFF.)

3. Keep pressing the “**Display Style**” soft key to select the necessary method.

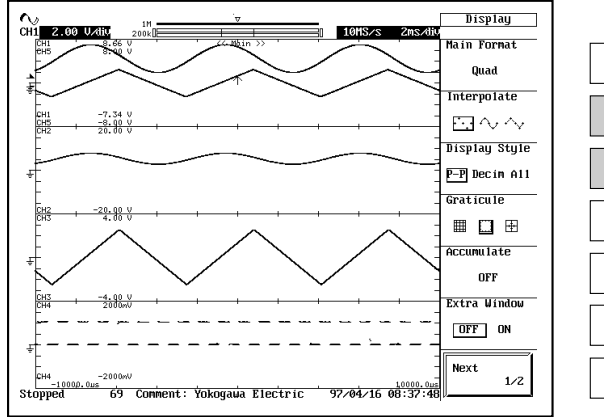

8.3 Changing the Graticule

Function

The graticule type can be selected from the following 3 types.

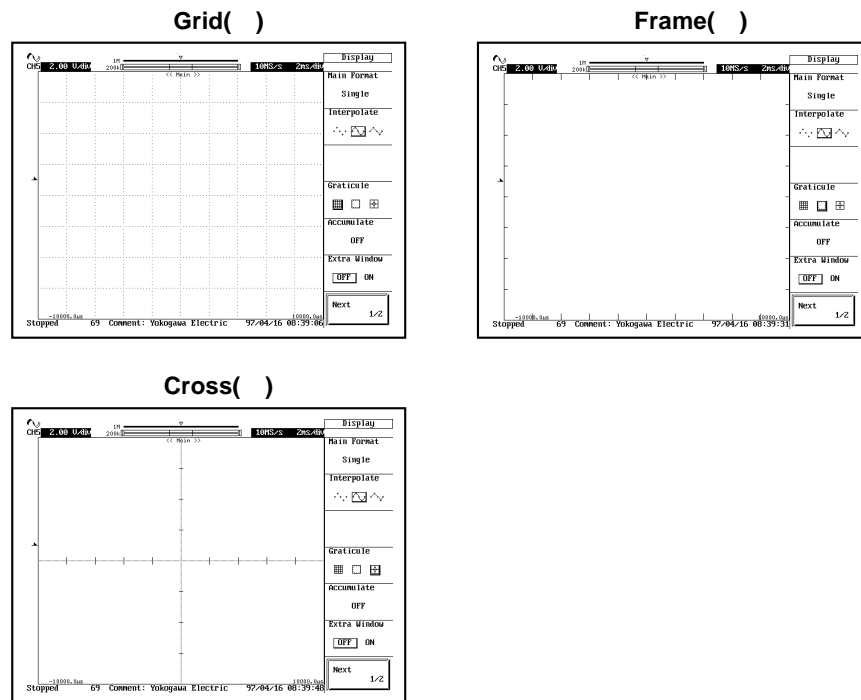

Operating Procedure

1. Press the **DISPLAY** key.
2. Press the **Graticule** soft key to select one of the three graticule types.

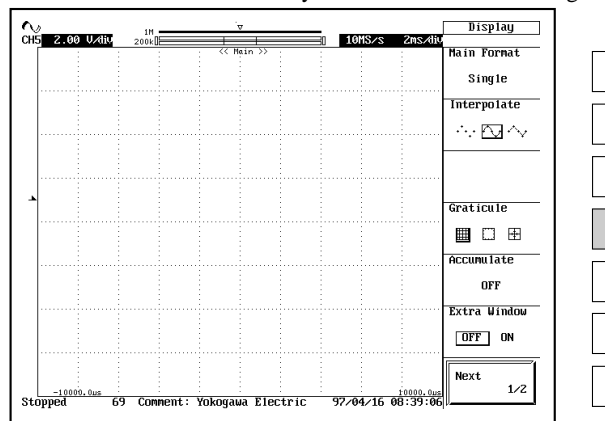

8.4 Accumulated Waveform Display

≡ For a description of this function, refer to page 1-16. ≡

Function

Normally the display is updated each time a trigger is activated. Therefore, it is difficult to observe instantaneous disturbance of a waveform. To solve this problem, the accumulation function has been provided. This function allows overlapping display of waveforms a specified number of times.

Accumulation modes

Persist mode : Allows overlapping display of waveforms in a single color (red in eight color shades).

If “Persist Count” is set to “Infinite”, only the latest waveform is displayed in the bright shade specified for each channel.

Color grade mode : Allows overlapping display of waveforms in eight colors according to the frequency of occurrence of the data values.

Accumulative count (for the persist mode)

In persist mode, the accumulative count can be set within the range given below. If “Infinite” is selected, overlapping display is performed indefinitely. The default setting is 16.

2 to 128 (steps of 2ⁿ), Infinite

Grade width (for color grade mode)

In color grade mode, the frequency of data value occurrence is indicated in eight colors as illustrated below. The grade width can be set within the range given below. The default setting is 16.

Overlapping display is performed indefinitely in color grade mode.

2 to 32 (steps of 2ⁿ)

| | When grade width = 4 | When grade width = 32 |
|--------------------|----------------------|-----------------------|
| Higher frequency ↑ | | |
| | red 24 to | red 192 to |
| | pink 20 to 23 | pink 160 to 191 |
| | yellow 16 to 19 | yellow 128 to 159 |
| | white 12 to 15 | white 96 to 127 |
| | cyan 8 to 11 | cyan 64 to 95 |
| | green 4 to 7 | green 32 to 63 |
| | blue 1 to 3 | blue 1 to 31 |
| | black 0 | black 0 |

For example, a dot which has appeared on the screen 100 times is displayed in red if the grade width is 4, or in white if the grade width is 32.

Points for attention

- Cursor measurement and automatic measurement of waveform parameters are performed on the latest waveform.
- It is not possible to use the history menu in accumulation mode. To use the history menu, switch OFF accumulation mode.
- Accumulated data cannot be output to the built-in printer or an external printer using the Centronics interface in different color shades.
- Only the latest waveform can be output to an external plotter.
- If acquisition is stopped with the **START/STOP** key is pressed, accumulation will be stopped temporarily. Re-starting acquisition will resume accumulation from the point at which acquisition was stopped.

Operating Procedure

Selecting averaging mode

1. Press the **DISPLAY** key.
2. Press the **“Accumulate”** soft key to select **“OFF”**, **“Persist”** or **“Color.”**
 Proceed to step 3 if you have selected **“Persist”**, or to step 4 if you have selected **“Color”**.

Setting the accumulative count (when “Persist” has been selected)

3. Turn the jog shuttle to set the desired accumulative count.

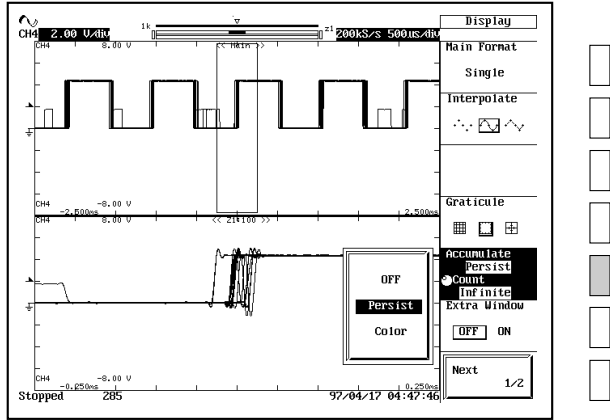

Setting the grade width (when “Color” has been selected)

4. Turn the jog shuttle to set the desired color width.

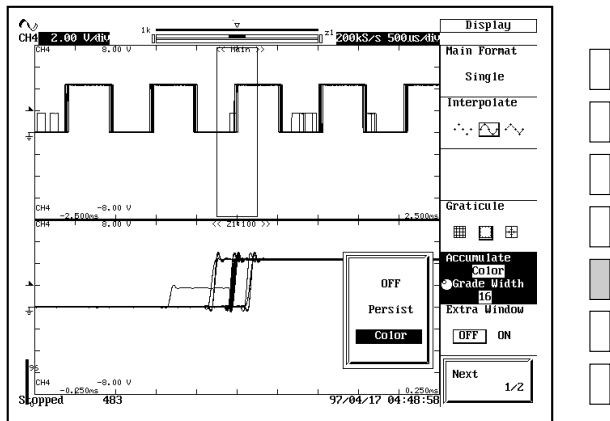

8.5 Turning the Extra Window ON/OFF

≡ For a description of this function, refer to page 1-15. ≡

Function

An extra window is provided to display information other than waveforms when waveforms obscure the information in the display area. The following three types of information can be displayed in the extra window.

- Cursor measure values
- Automatically measured waveform parameter
- Digital values of measuring data*

* This function is available on DL708Es with firmware versions 4.00 or later.

Cursor measured values

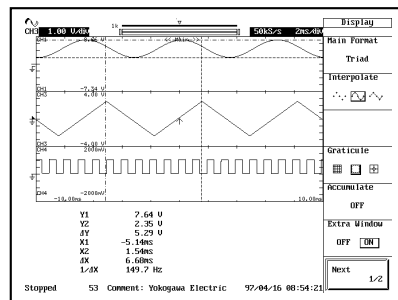

Automatically measured waveform parameters

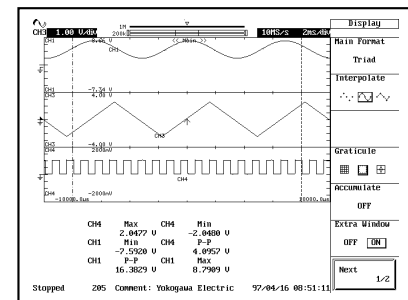

The number of display points available in the vertical direction when the extra window is ON

When the extra window is set to ON, the vertical size of the waveform display area is reduced by 2/3. However, the vertical resolution remains unchanged.

- ON : 288 points
- OFF : 432 points

(When the display format is “Single”)

Note

Use of the extra window together with certain zoom formats may cause scale values (at the top and bottom of each waveform window) to overlap, so that they become difficult to read.

Operating Procedure

1. Press the **DISPLAY** key.
2. Press the “Extra Window” soft key to select “ON” or “OFF.”

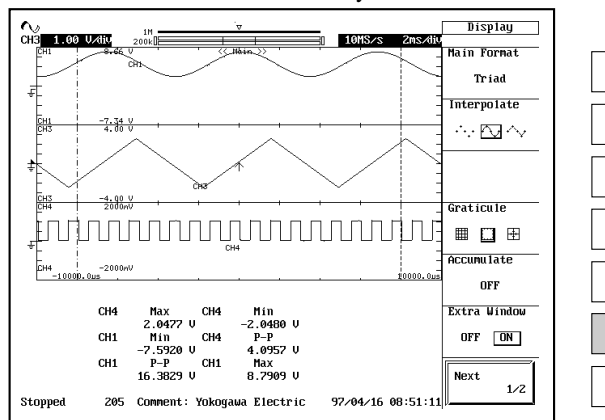

8.6 Turning Display of the Scaling Value and Trigger Mark ON/OFF

≡ For a description of this function, refer to pages 1-15. ≡

Function

For each channel, you can select to display scale values at the top and bottom of the vertical axis. You can also select whether to display the trigger-position marker (“trigger mark”).

Operating Procedure

Set the scale-value display ON or OFF

1. Press the **DISPLAY** key.
2. Press the “**NEXT**” soft key, so that it changes to “**NEXT 2/2.**”
3. Press the “**Scale Value**” soft key to set the feature “**ON**” or “**OFF.**”

Set the trigger mark ON or OFF

4. Press the “**Trigger Mark** ↑” soft key to set the trigger mark “**ON**” or “**OFF.**”

Changing how the pop-up menu is displayed

5. Press the “**Translucent**” soft key to select “**ON**” or “**OFF.**”
6. When set to “**ON,**” the pop-up menu becomes translucent and the waveform data underneath the menu becomes visible.

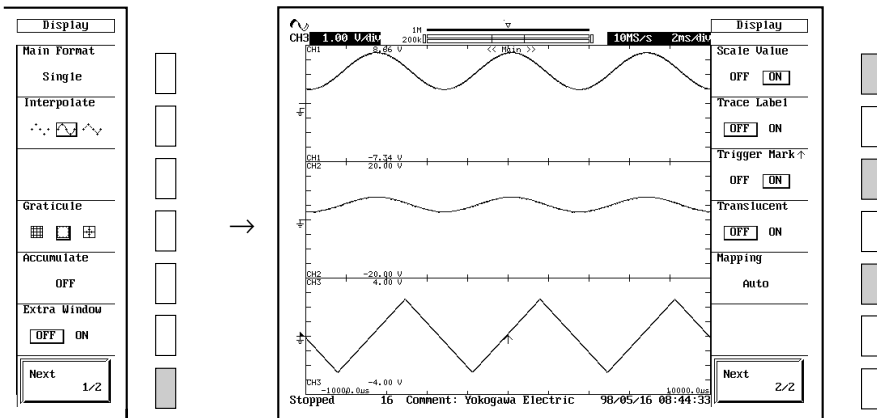

8.7 Setting the Waveform Labels

≡ For a description of this function, refer to page 1-15. ≡

Function

Label display ON/OFF (Trace Label)

Use this parameter to select whether or not to include waveform labels (channel identification labels) on the display.

Entering customized labels

You can use the Define Label feature to enter customized labels for each channel. Each label is a character string of up to eight alphanumeric. You can set the label display ON/OFF using the Trace Label function; the label appears in the scale-value display and with measurement results.

Operating Procedure

Entering a label

1. Press a channel key (**CH1** to **CH8**) to select the channel whose label you want to set.
2. Press the “**Next**” soft key, so that it changes to “**Next 2/2**”.
3. Press the “**Define Label**” key to display the virtual keyboard. Then enter the alphanumerics for the label.

Set the label display ON or OFF

4. Press the **DISPLAY** key.
5. Press the “**Next 1/2**” soft key, so that it changes to “**Next 2/2**”.
6. Press the “**Trace label**” soft key to set the label display “**ON**” or “**OFF**”.

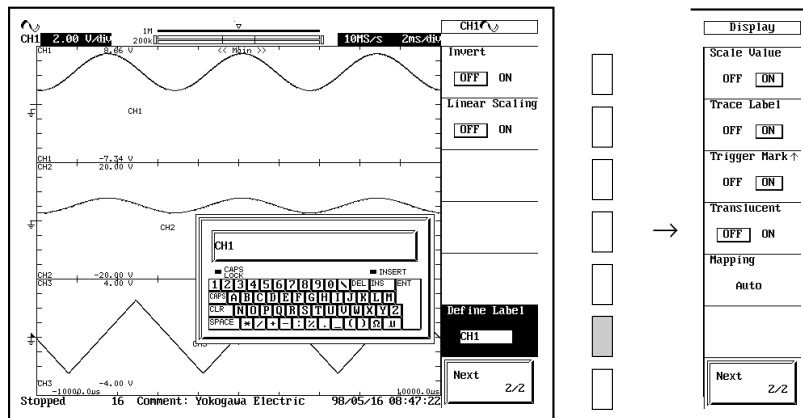

Note

Waveform labels may not be displayed if a display area allocated for a waveform becomes narrow because of the display format or the zoom format settings.

8.8 X-Y Waveform Display

≡ For a description of this function, refer to page 1-17. ≡

Function

Assignment of X (horizontal) and Y (vertical) axes

X axis : Any trace (CH1,...,CH8, Math1, Math2)

Y axis : All other traces for which display is set ON.

Display format (Mode)

You can choose either of the following display formats.

T-Y & X-Y : Top windows shows normal (T-Y) waveforms; bottom window shows X-Y waveform.

X-Y : Screen shows X-Y waveform only.

X-Y display range (Start Point and End Point)

The X-Y display shows the selected area (range) of the T-Y display. You can set the start and stop points along the time axis of the T-Y display (anywhere within ± 5 div from the center of the time-axis display). The start point is indicated by a dot-dash-dot line on the display, while the end point is indicated by a dashed line. Note that you cannot make range settings if the mode is set to X-Y.

Setting step : $T/\text{div} \times 10^{\pm}$ displayed-record-length

Linkage

Set this feature ON to links the “Start Point” and “End Point” settings, so that you can shift the X-Y waveform display area while retaining the same distance between start and end points.

Restrictions and precautions

- For the T-Y & X-Y format, the T-Y display area is divided into waveform windows in accordance with the Main Format setting (**DISPLAY** key).
- The zoom functions operate on the T-Y area only. The T-Y area can not show zoom and main windows together: you can use only the Main, Z1, and Z2 zoom formats.
- If the horizontal axis unit is in time on one trace and in frequency on another trace, the X-Y waveform is not displayed.
- To zoom the X-Y waveform, use the “**V Zoom/Offset**” soft key of the **CH** key. For the operation procedure, refer to “5.8 Zooming in the Vertical Direction.”
- Logic input waveform cannot be displayed in X-Y waveform display.

Operating Procedure

1. Press the **SHIFT+DISPLAY** key (X-Y).

Set the display format

2. Press the **"MODE"** soft key as necessary to select the format: **"OFF"**, **"T-Y & X-Y"**, or **"X-Y"**.
3. Press the **"X Trace"** soft key as necessary to select the X-axis waveform (CH1, ..., Math2). **"CH1"** to **"CH8"** can be directly selected by pressing **CH1** to **CH8**.
Channels which do not have input modules installed are not displayed on the menu.

Set the display range

4. Press the **"Start Point"** soft key to set the jog shuttle action to **"Start Point"**.
Then turn the jog shuttle to set the start point.
5. Press the **"End Point"** soft key, and use the jog shuttle to set the end point.
6. If necessary, press the **"Linkage"** soft key to set the linkage **"ON"** or **"OFF"**.

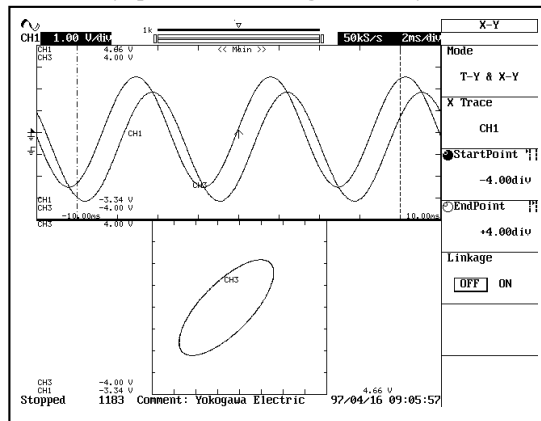

8.9 Zooming the Waveform

≡ For a description of this function, refer to page 1-17. ≡

Function

The instrument can display up to two zoom windows for each of waveforms selected for display. You can set the zoom function on or off for each of the display waveforms. Note that zooming cannot function on areas with less than 11 display points.

Zoom display mode (Mode)

- Main : Screen shows main (unzoomed) waveform(s) only.
- Main&Z1 : Upper part of screen shows main waveform(s), while lower part of screen shows zoom of the Z1 area.
- Z1 only : Screen shows zoom of Z1 area only.
- Main&Z1&Z2 : Upper part of screen shows main waveform(s); lower left part shows Z1 zoom(s); lower right part shows Z2 zoom(s).
- Z2 only : Screen shows zoom of Z2 area only.
- Z1&Z2 : Upper part of screen shows Z1 zoom (s), while lower part of screen shows zoom of Z2 zoom (s).

Allocation

Use this parameter to select the waveform channels to be zoomed (CH1, ..., CH8, Math1, Math2). Note that you can set the value ON only if the corresponding channel display is also set ON. If you set the Allocation to OFF, the screen will not show a zoom display for that channel.

Zoom Format

Selects the number of waveform windows on the display. Note that you cannot set separate values for Z1 and Z2 displays. Select from any of six formats: Main*, Single, Dual, Triad, Quad, Hexa or Octal.

* Selecting main results in the same format as the “Main Format” of *DISPLAY* key.

Zoom rate (magnification)

- The maximum available zoom depends on the displayed record length: [Maximum zoom = displayed-record-length x 1/10].
Note that the “displayed record length” is not always identical to the “record length” in the acquisition memory. For details, refer to Appendix 1.
- You can use different zoom rates for Z1 and Z2 windows.

Setting the zoom rate (Z1 Mag, Z2 Mag)

You can set the zoom rate in 1-2-5 time-axis steps. The value is displayed on the upper right corner of the zoom waveform display frame.

Zoom positions (Z1 Position, Z2 Position)

- You set the zoom position (center of the Z1 or Z2 zoom slice) by its distance from the center of the screen, in time-axis divisions. The setting range is {-5div, ..., +5div}. The setting step is: {T/div x 10 ÷ displayed-record-length}.
- The Z1 zoom slice (also called “zoom box”) is indicated by solid vertical lines drawn through the main waveform(s). The Z2 box is indicated by dashed lines. You can change the positions independently. If the mode is Main&Z1&Z2, making the jog shuttle marks of both “Z1 Position” and “Z2 Position” soft keys white (●) allows you to move the zoom position without changing the distance between Z1 and Z2.
- If the mode is Main&Z1&Z2, the main waveform area will show both the Z1 and Z2 boxes.
- The T/div setting during the roll mode display may sometimes be inadequate for observing the changes in the waveform on the main area. In this case, open a zoom window (for example, Main&Z1) and set the zoom position to the right edge. The zoom area will show the most recent waveform zoomed and the changes in the waveform can be observed. If the waveform acquisition is stopped before the waveform reaches the right edge of the main area in this condition, the waveform may disappear from the zoom area. However, if you move the zoom box to the position where there are waveforms in the main area, the waveform reappears.

Display position of original waveforms : Main Position

If the record length is 2 MW or more (the maximum record length that can be displayed is 1 MW) or if the display record length is shorter than the set record length, there are data outside the display screen. To observe the data which is outside the display screen, move the display position horizontally with “Main Position.” It can be set in units of 0.1 % with the left most data acquired in the acquisition memory to be 0 %.

Zoom display during roll mode

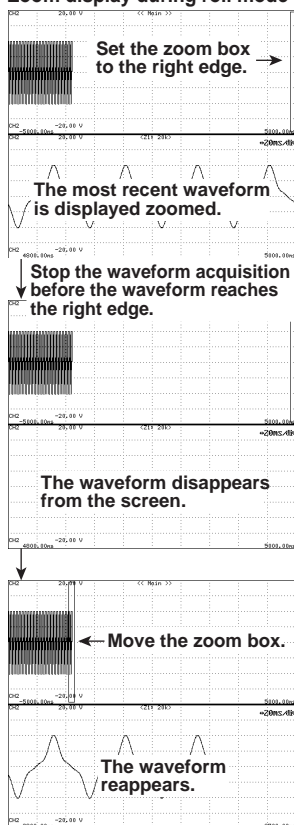

Moving the range in which to perform automatic measurement of waveform parameters: Fit Measure Range

Pressing the “Fit Measure Range...” soft key moves the range in which to perform the automatic measurement of waveform parameters to the ends of the Z1 or Z2 waveform display frame. Whether it moves to the ends of the Z1 frame or the Z2 frame depends upon how the zoom waveform is being displayed. See below.

- If the mode is “Main&Z1,” “Z1 Only,” “Main&Z1&Z2,” or “Z1&Z2,” it moves to the Z1 waveform display frame.
- If the mode is “Main&Z2” or “Z2 Only,” it moves to the Z2 waveform display frame.

Page Scroll

You can scroll the display of the waveform to the left or to the right. Pressing the “Page Scroll” soft key moves the displayed position by one screen in the direction specified in “Page Scroll Direction.” You can page scroll when only the original waveforms (main waveforms) are displayed.

>> : Move the waveform display position to the right on the screen.

<< : Move the waveform display position to the left on the screen.

Operating Procedure

Set the zoom display format

1. Press the **ZOOM** key.
2. Press the “**Mode**” soft key as necessary to set the zoom mode (Main, ..., Z1&Z2).

Select the waveforms for zooming

3. Press the “**Allocation**” soft key to produce the allocation menu.
4. Move the cursor to the trace to zoom with the jog shuttle, and press **SELECT** key to turn it ON.

Set the zoom display mode

5. Press the “**Zoom Format**” soft key as necessary to select the mode (One, ..., Octal).

Set the zoom rate

6. Press the “**Z1 Mag**” or “**Z2 Mag**” soft key to enable the jog shuttle. Then turn the jog shuttle to set the desired zoom rate (magnification).

Set the zoom positions

7. Press the “**Z1 Position/Z2 Position**” soft key to set the jog shuttle action to “**Z1 Position**,” then turn the jog shuttle to set the position. Set the Z2 position in the same way.

Setting the display position of an original waveform

8. Press the “**Main Position**” soft key to enable the jog shuttle.
9. Move the display position of the original waveform with the jog shuttle.

Set the linkage (when Main&Z1&Z2 mode only)

10. Press the “**Z1 Position/Z2 Position**” soft key several times. If both “**Z1 Position**” and “**Z2 Position**” are , “**Z1 Position/Z2 Position**” moves without the distance between them changing.

Moving the range of automatic measurement of waveform parameters

11. Pressing the “**Fit Measure Range...**” soft key moves the range to the ends of the zoom waveform display frame.

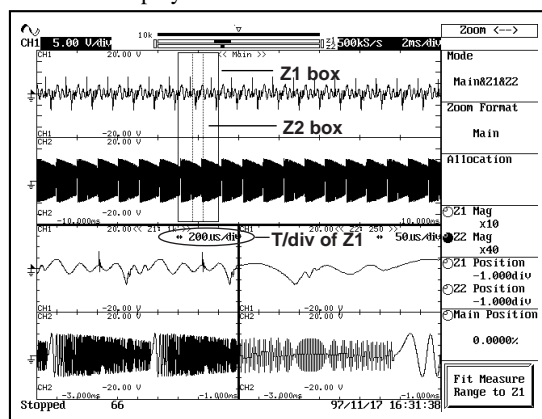

Page Scroll (when using Main mode only)

- 12. Press the “Page Scroll Direction” soft key to select “<<” or “>>.”
- 13. The waveform display position moves by one screen, every time the “Page Scroll” soft key is pressed.

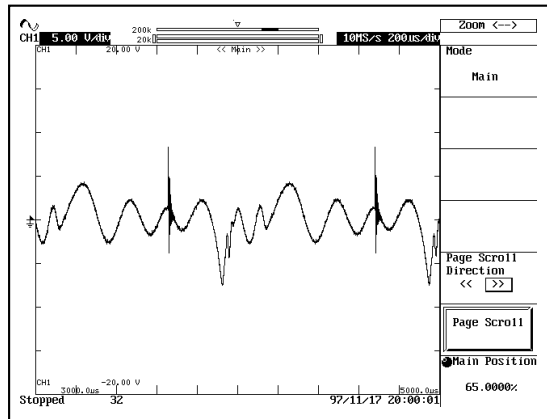

9.1 Measuring Waveforms using Cursors

≡ For a description of this function, refer to page 1-19. ≡

Function

Restrictions

Cursor measurements cannot be used with the following waveform types.

- Snapshot waveforms
- Accumulated waveforms (except for most recent waveform)

Cursor types and measurement values

- Marker cursors: Used to measure specific positions on the waveform. (The markers automatically move along the waveform.) You can set Cursors 1 and Cursor 2 onto the same waveform or onto different waveforms.

| | |
|--------------|---|
| Y+ | Y-axis value at Cursor 1. |
| Yx | Y-axis value at Cursor 2. |
| ΔY | Y-axis difference between Cursor 1 and 2. |
| X+ | X-axis value at Cursor 1 |
| Xx | X-axis value at Cursor 2 |
| ΔX | X-axis difference between Cursor 1 and 2 |
| $1/\Delta X$ | Reciprocal of ΔX value |

- H (Horizontal) cursors: Used to measure Y-axis values

| | |
|------------|---|
| Y1 | Y-axis value at Cursor 1. |
| Y2 | Y-axis value at Cursor 2. |
| ΔY | Y-axis difference between Cursor 1 and 2. |

- V (Vertical) cursors: Used to measure X-axis values

| | |
|--------------|---|
| X1 | X-axis value at Cursor 1. |
| X2 | X-axis value at Cursor 2. |
| ΔX | X-axis difference between Cursor 1 and 2. |
| $1/\Delta X$ | Reciprocal of ΔX value |

* The X-axis values of the V cursors that are used as user defined cursors (described later) will take on values that correspond to the specified reference width.

- H&V cursors: Used to measure both X-axis and Y-axis values

| | |
|--------------|---|
| Y1 | Y-axis value at Cursor 1. |
| Y2 | Y-axis value at Cursor 2. |
| ΔY | Y-axis difference between Cursor 1 and 2. |
| X1 | X-axis value at Cursor 3. |
| X2 | X-axis value at Cursor 4. |
| ΔX | X-axis difference between Cursor 3 and 4. |
| $1/\Delta X$ | Reciprocal of ΔX value |

- User defined cursors:

You can define a zero point (position of cursor Ref1) and an end point (position of cursor Ref2) to be used as a reference for the measurement. The positions of two V cursors (Cursor1 and Cursor2) can be measured with respect to the reference. The reference width between the zero point and the end point and the measurement unit can be arbitrarily set within a certain range.

The measured parameters are the same as those of the V cursors.

Range of the reference width: 0.0001E-25 to 1.0000E+30. You can also set 0, but the measured values become meaningless in this case.

Unit: three alphanumerical characters or less

Movement range for H cursors

Cursors can be moved from -4 div to +4 div along the vertical axis, relative to the center of the display.

The movement step is: $T/\text{div} \times 8 \div 384$

Movement range for V cursors

Cursors can be moved from -5 div to +5 div along the horizontal axis, relative to the center of the display.

The movement step is: $T/\text{div} \times 10 \div \text{displayed-record-length}$

Movement range for marker cursors

These cursors move along the selected waveform. If two samples (max and min values) are located at the same X-axis location, you can use the marker to read off the values in order of sampling (see drawing at right).

Linkage ON/OFF

You can use the Linkage setting to lock the distances between Cursor1 and Cursor2, Cursor3 and Cursor4, and Ref1 and Ref2. -- so that each time you move one cursor, the other one automatically moves by the same amount.

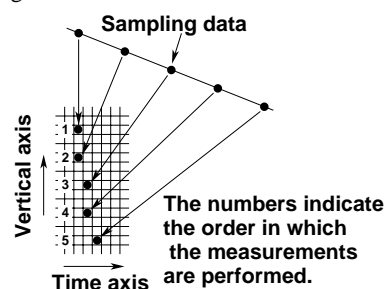

Marker jump to the original waveform display frame: Marker Jump

Sometimes the marker cursor goes out of the waveform display frame when the waveform is being zoomed or when the display record length is shorter than the set record length. In such case, this allows the marker cursor to jump to the center of the waveform display frame. The operating procedure is explained below.

- M1 to Z1 : Jump Cursor1 to the center of the Z1 zoom waveform display frame
- M1 to Z2 : Jump Cursor1 to the center of the Z2 zoom waveform display frame
- M2 to Z1 : Jump Cursor2 to the center of the Z1 zoom waveform display frame
- M2 to Z2 : Jump Cursor2 to the center of the Z2 zoom waveform display frame
- M1 to Main : Jump Cursor1 to the center of the waveform display frame
- M2 to Main : Jump Cursor2 to the center of the waveform display frame

Points for attention during cursor measurement

- Horizontal axis values are measured from the trigger position (excludes user defined cursors.)
- “***” will be displayed if measurement is impossible.
- Measured values can be displayed in the extra window. For details refer to page 8-7.
- When the marker cursor is outside the waveform display frame, only the horizontal axis value is displayed.
- If the logic waveform (Logic Input Module) or simultaneous binary computation of all channels waveform is being measured with the cursor, the values are displayed as follows.
 Marker cursor : Displays “***” for the vertical axis value.
 H cursor : Displays “***”.
 V cursor : Displays binary values with the MSB set to CH1 and the LSB set to CH8 (waveforms of simultaneous binary computation of all channels).
 Displays the binary values with the MSB set to bit8 of POD B and the LSB set to bit1 of POD A (logic waveform).

Cursor measurement is invalid for user defined cursors and when displaying X-Y waveform.

Operating Procedure

Selecting the cursor type

1. Press the **CURSOR** key.
2. Press the **“Type”** soft key to display the cursor type menu.
3. Keep pressing the **“Type”** soft key to select the desired cursor type.

Selecting the waveform source

4. Keep pressing the **“Cursor1 Trace”** soft key until the desired waveform source is selected. **“CH1”** to **“CH8”** can be directly selected by pressing **CH1** to **CH8**. Channels which do not have input modules installed are not displayed on the menu.
5. If **“Marker”** has been selected as the cursor type, press the **“Cursor2 Trace”** soft key to select the desired waveform source.

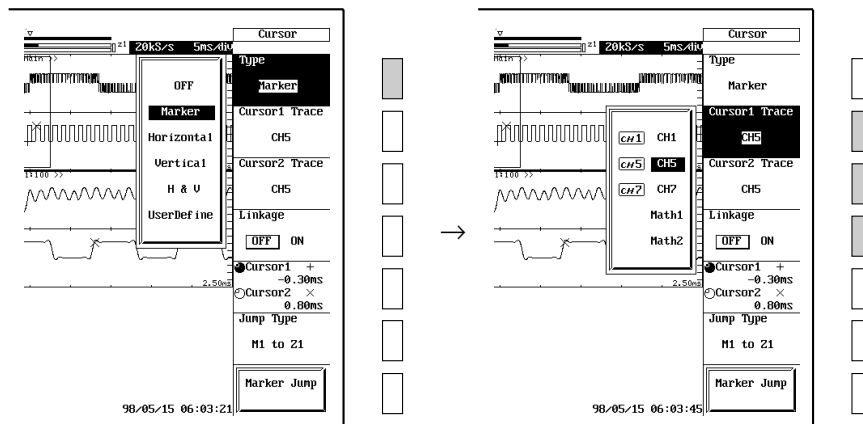

**Setting the reference width (only when the cursor type is set to “UserDefine”)
Moving Cursors Ref1 and Ref2**

6. Press the “Ref1/Ref2” soft key and set the jog shuttle action to “Ref1.”
7. Move Ref1 with the jog shuttle, and set the zero point.
8. Similarly, move Ref2 and set the end point.

Setting the reference width

9. Press the “Reference Value” soft key and set the jog shuttle action to “Reference Value.”
10. Set the reference width with the jog shuttle.

Setting the unit

11. Press the “Unit” soft key to display the keyboard.
12. Set the unit. You can enter up to three characters.

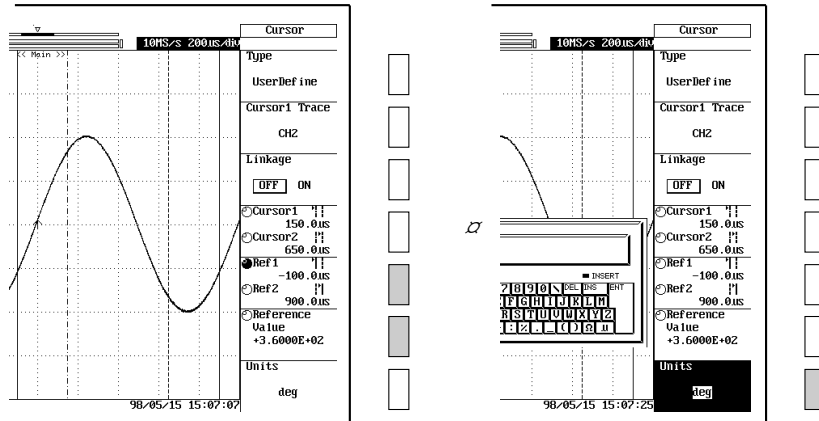

Moving the cursor

13. Press the “Cursor2” soft key.
 - Cursor 1 can now be moved using the jog shuttle.
 14. Turn the jog shuttle to move cursor 1.
 15. If “Linkage” was set to OFF in step 6, move Cursor 2.
- If “H & V” was selected in step 3, move Cursor 3 and Cursor 4 as well.

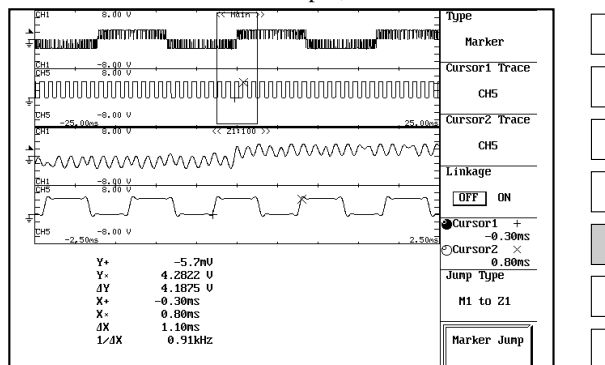

Marker cursor jump (Available only if cursor type is Marker)

4. Press the “Jump Type” soft key the appropriate number of times to select the marker you wish to jump and its destination.
5. Pressing the “Marker Jump” soft key moves the marker to the destination screen.

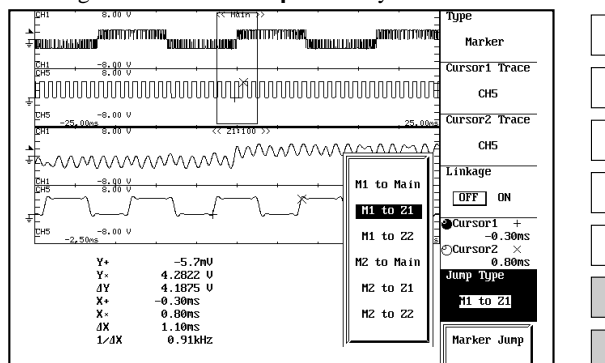

Turning ON/OFF the function to move the two cursors simultaneously

Press the “Linkage” soft key and select “ON” or “OFF.”

Note

The menu varies depending on the selected cursor type.

9.2 Automatic Measurement of Waveform Parameters

≡ For a description of this function, refer to page 1-19. ≡

Function

You use this function to generate automatic measurements of waveform characteristics based on data in the acquisition memory.

Restrictions

Automatic measurement cannot be used with the following waveform types.

- Snapshot waveforms
- Accumulated waveforms (except for most recent waveform)
- A waveform that is not being triggered.
- Logic waveforms

Selection of High/Low method (High/Low Mode)

The “High” value is the 100% voltage level used in measurements of rise time, fall times, and other such parameters. The “Low” value is the 0% level. You can select one of two methods for setting the High and Low levels.

- **Auto**

The instrument automatically sets the voltage level at high amplitude to “High,” and the level at low amplitude to “Low.” It does this by detecting reoccurring voltage levels within the measurement area, while taking into account the occurrence of spikes and ringing. This method is best when working with square waves and pulse waves.

- **Max-Min**

The maximum voltage level within the measurement area is taken as “High,” and the minimum level is taken as “Low.” This method is best for measuring sine waves and sawtooth waves, but is not appropriate for waves that include spikes, ringing, or other such phenomena.

Distal, mesial, and proximal settings (Distal/Prox Mode)

The distal, mesial, and proximal levels serve as reference points for measurements of rise time, fall time, and other such parameters. You can select any of three methods for setting these values.

- **Auto**

Sets distal to 90% level, mesial to 50% level, and proximal to 10% level, relative to 100% at High and 0% at Low.

- **Manual**

Lets you set arbitrary levels for distal, mesial, and proximal levels. Settings are in percent, relative to 100% at High and 0% at Low.

- **Unit**

Lets you set the distal, mesial, and proximal values for any trace (CH1 to CH8, Math1, Math2) to arbitrary voltage values or temperature.

Delay reference (Delay Ref)

The “delay reference” is used as the starting point for measuring delay time. Select one of the following.

Trig : Trigger point

CH1, ..., CH8 : Center (mesial) point of the first rise or fall (within the measurement area) of the waveform on the selected channel.

When “Delay Ref” is set to CH1 to CH8, the Delay Ref line becomes the measurement start line of the delay reference waveform.

Selecting the slope for the starting point of delay

When CH1 to CH8 is selected for the Delay Ref, the starting point of the delay measurement can be selected on what condition the signal passes the mesial point.

f : Center (mesial) point of the first rise of the waveform

f↓ : Center (mesial) point of the first fall of the waveform

f↕ : Center (mesial) point of the first rise or fall of the waveform

Measurement Range (Time Range)

As the default, measurement starts at -4div from the display center and extends to +4div, but you can shorten the range. You make the setting by positioning two vertical lines: a dot-dash line for the start point, and a dashed line for the end point.

Measurement parameters (Items)

You can select from among the following 26 parameters. You can measure up to a total of eight parameters simultaneously.

• **Voltage-axis parameters**

- Max : Maximum voltage [V] Avg : Average voltage $(1/n)\sum xi$ [V]
- Min : Minimum voltage[V] Rms : Root mean square value $(1/\sqrt{n})(\sum(xi)^2)^{1/2}$ [V]
- High : High level voltage [V] P-P : Peak to peak value (Max-Min) [V]
- Low : Low level voltage[V] StdDev : Standard deviation $(1/n(\sum xi^2 - \sum(xi)^2))^{1/2}$
- Amp : Amplitude (High-Low) [V] +OShot : Overshoot (Max-High)/(High-Low) [%]
- OShot : Overshoot (Low-Min)/(High-Low) [%]

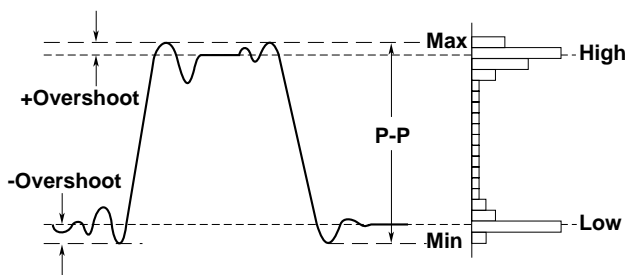

• **Time-axis parameters**

- +Duty : +Duty rate $(+Width)/Period \times 100$ [%]
- Duty : -Duty rate $(-Width)/Period \times 100$ [%]
- Freq : Frequency (Hz)
- Period : Period [s]
- Rise : Rise time [s]
- Fall : Fall time [s]
- +Width : Width above mesial value [s]
- Width : Width below mesial value [s]

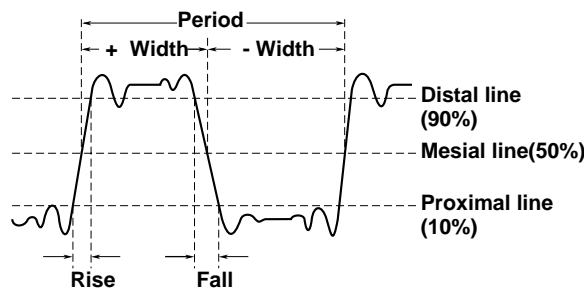

RDelay,FDelay : Delay time [s]

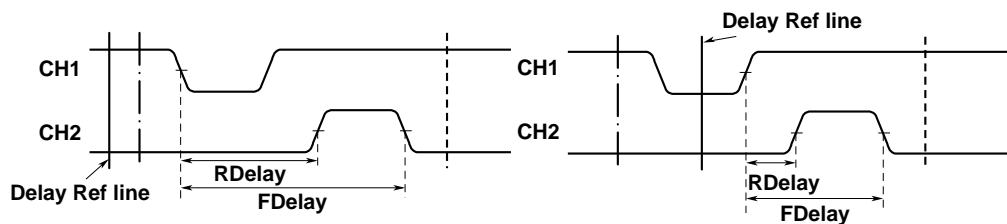

CH2 RDelay/FDelay(When Delay Ref = CH1)

• Other parameters

Histo : Frequency distribution of voltage values

Int1TY : Area under positive amplitude

Int2TY : (Area under positive amplitude) – (area under negative amplitude)

Int1XY : Summation of triangular area in X-Y waveform

Ing2XY : Summation of trapezoidal area in X-Y waveform

* For details about area calculations, refer to Appendix 3 (page App-4).

Restrictions and precautions

- The automatic measurement of waveform parameters is performed on the data acquired in the acquisition memory not the data displayed on the screen. Therefore, the frequency distribution of the data may not match the waveform that are zoomed vertically (settings other than “×1” on the voltage module) or the waveform of temperature/strain module.
- If measurement was impossible, the screen displays “***” in place of the value.
- Waveforms with small amplitudes may return incorrect measurement results.
- If the measurement area contains more than one period, measurement is carried out on the first period only.
- Measurement results may in some cases be inconsistent with the displayed waveform, since automatic measurement is not synchronized with the display update. You can ensure consistency by stopping the waveform acquisition.
- Logic waveform (Logic Input Module) cannot be automatically measured.
- If the input signal is that of a temperature module, the following parameters cannot be automatically measured for any other unit besides “°C.”
Int1TY, Int2TY, Int1XY, Int2XY

Operating Procedure

1. Press the **MEASURE** key.
2. Press the “**Mode**” soft key to select “**ON**”.

Selecting the waveform

3. Keep pressing the “**Trace**” soft key to select the desired waveform source from “**CH1**” to “**Math2**”.
“**CH1**” to “**CH8**” can be directly selected by pressing **CH1** to **CH8**.
Channels which do not have input modules installed are not displayed on the menu.

Selecting the parameters

4. Press the “**Item**” soft key to display the item menu.
5. Turn the jog shuttle to move the cursor to the desired item (parameter).
Selecting “**Clear**” will turn OFF all items.
6. Press the **SELECT** key to turn ON the desired item.
7. Repeat steps 3 to 6 until all the parameters you wish to measure are selected.

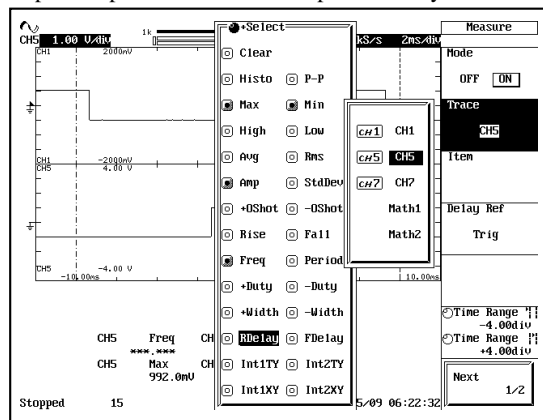

Setting the measurement range

8. Press the “Time Range” soft key.
9. Turn the jog shuttle to set the desired measurement range.

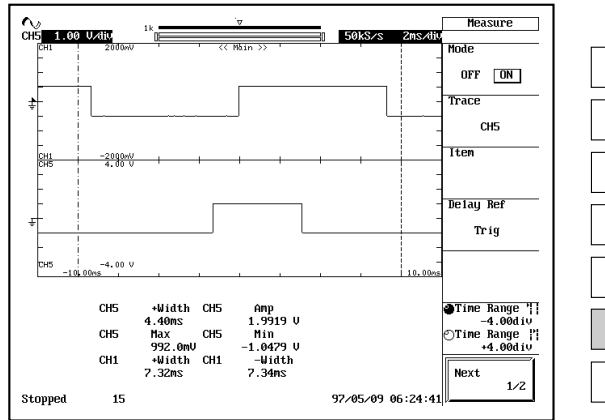

Setting the delay start point (for measurement of RDelay and FDelay)

9. Keep pressing the “Delay Ref” soft key to select the desired source of the delay start point from “Trig” to “CH8”.
 - “CH1” to “CH8” can be directly selected by pressing **CH1** to **CH8**.
 - Channels which do not have input modules installed are not displayed on the menu.

When one of the channels CH1 to CH8 is set as the Delay Ref

10. Turn the jog shuttle to set the delay measurement start line (indicated by the continuous line on the screen).
11. Press the “Delay Ref Slope” soft key to select the slope.

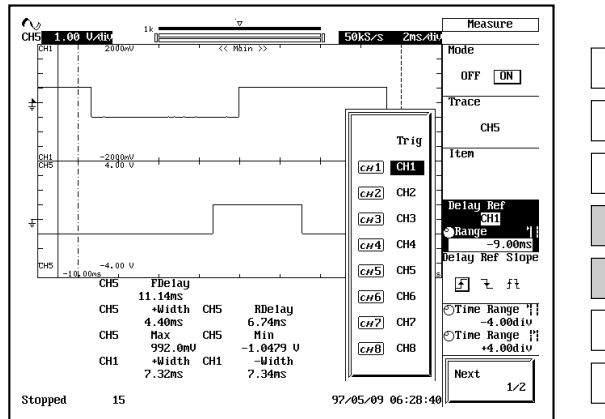

Setting the distal and proximal points (Auto and Manual)

10. Press the “Next” soft key to display the “Next 2/2” menu.
11. Press the “Dist/Prox Mode” soft key to select “Auto” or “Manual”.
12. Press the “Distal” soft key.
 - The distal point can be set using the jog shuttle.
13. Turn the jog shuttle to set the desired distal point.
14. In the same way, set the proximal and mesial point.

Setting the distal and proximate points (Unit)

10. Press the “Next” soft key to display the “Next 2/2” menu.
11. Press the “Dist/Prox Mode” soft key as necessary to select Unit.
12. Press the “Trace” soft key to select the trace target.
13. Press the “Distal” soft key to set the jog shuttle action to Distal.
14. Turn the jog shuttle to set the distal point.
15. Set the mesial and proximal points in the same way.

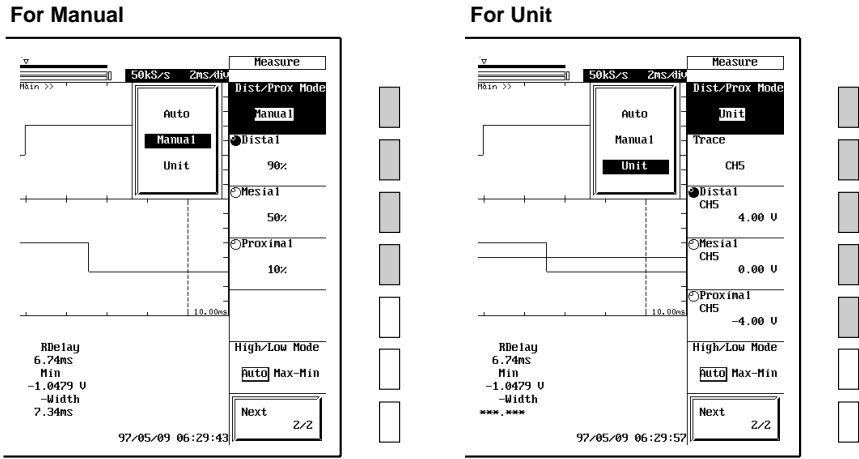

Setting High/Low points

10. Press the “Next” soft key to display the “Next 2/2” menu.
11. Press the “High/Low Mode” soft key to select “Auto” or “Max-Min”.

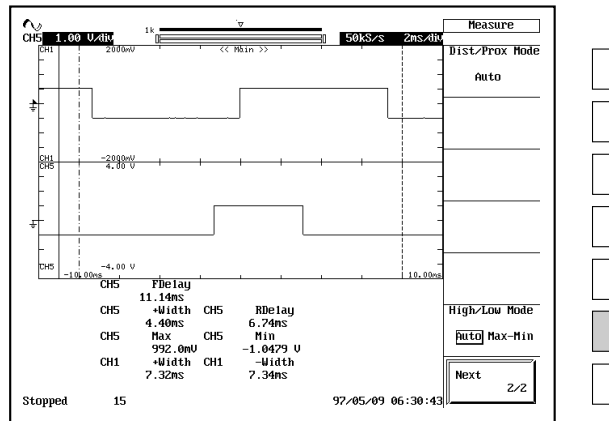

Note

- You can select up to eight items in total on all channels. However, Histo can be selected independently of the eight items.
- The trace and item menus can be displayed at the same time. This is useful when you wish to measure parameters on multiple channels.
- For measurement of delay (Delay Ref: CH), the mesial point next to the continuous line (vertical line) is used as the reference point.
- If Delay Ref is set to a channel (CH1 to CH8), the measurement range extends from the Delay Ref line to the right edge of the screen.

9.3 Setting Computing Range and Display Units, and Recomputing

Function

Computing range (Start Point/End Point)

- The instrument can execute automatic computation on up to 100 kW when using only Math1 and up to 50 kW when using Math1, 2. When displaying a waveform of 100 kW or more, computation on all of the data cannot be performed at once.
- You can set the start and end points to any area along the time axis (from -5div to +5div from the screen center). The start point is indicated by a dot-dash line on the display, while the end point is indicated by a dashed line. The setting step is: $T/div \times 10 \div \text{displayed-record-length}$. Note that the “displayed record length” is not always identical to the “record length” in the acquisition memory. For details, refer to Appendix 1.
- Please re-execute the computing each time you change the computing area.

Displayed unit (Unit Math1, Unit Math2)

You can enter any dimensional unit (up to 4 characters). The selected unit is reflected in the scale values.

Recomputing (Exec)

When this instrument is displaying the computing results using auto scaling, scaling is not carried out for every data update. Please re-execute the computing as necessary to maintain proper scaling, and whenever you change the computing range.

Operating Procedure

Setting the computing area

1. Press the **MATH** key.
2. Press the “**Mode**” soft key as necessary to select “**Basic**”, “**Phase**”, “**Binary**”, or “**User**”.
3. Press the “**Start Point/End Point**” soft key so that the jog shuttle is set to Start Point.
4. Turn the jog shuttle to set the start point.
5. Press “**Start Point/End Point**” again to set the jog shuttle to End Point. Then turn the jog shuttle to set the end point.
6. Press the “**Exec**” soft key to re-execute the calculation.

Setting the displayed unit

3. Press the “**Next**” soft key several times to display the screen for setting the displayed unit.
4. Press the “**Scale & Unit**” soft key to display the scaling value setting menu. Move the cursor to “**Unit**” and press **SELECT** key to display the keyboard. Then, enter the character string of the unit.

Repeating the computing

3. Press the “**Exec**” soft key to re-execute the computing.

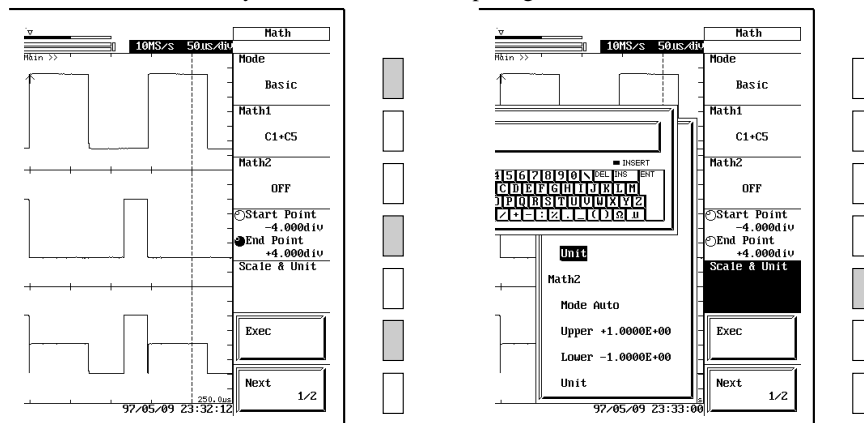

9.4 Waveform Addition, Subtraction and Multiplication

Function

Use the following procedure to add, subtract, or multiply waveforms from two different channels. Channel allocation is as follows.

Math1 : (Basic) CH1 and CH2; or CH1 and CH5

Math2 : (Basic) CH1 and CH3; or CH3 and CH7

Math1 and Math2 calculations can operate simultaneously.

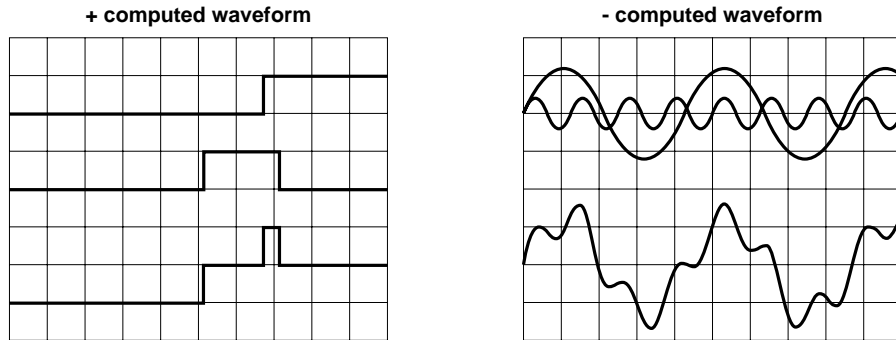

Operating Procedure

Selecting the computation mode

1. Press the **MATH** key.
2. Press the “**Mode**” soft key to display the math menu.
3. Keep pressing the “**Mode**” soft key until “**Basic**” is selected.

Setting the addition and subtraction type

4. Press the “**Math1**” or “**Math2**” soft key to display the Math menu.
5. Press the same soft key again to select the desired type.

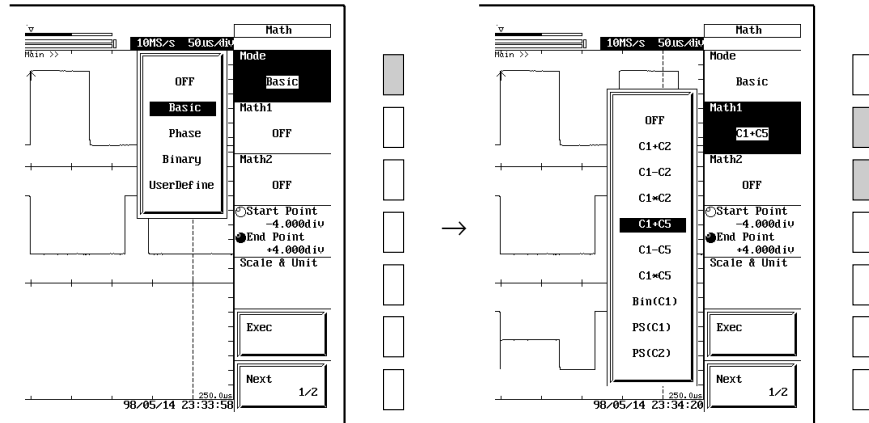

Note

- “Bin(C1)” of Math1 menu, and “Bin(C2)” and “Bin(M1)” of Math2 menu are described on the following pages.
- Addition and subtraction can be performed with the phase shifted. However, the addition and subtraction type differ between the basic mode and the phase mode. For details refer to page 9-13.
- For information about “PS(1)” and “PS(2)” of Math1 menu, and “PS(5)” of Math2 menu, refer to Section 9.8, “Displaying Power Spectrums.”

9.5 Binary Computation

Function

Use this function to convert the CH1, CH2, or Math1 waveform to a two-level digital signal (0 and 1 levels only). Conversion is made with respect to two specified threshold levels, as illustrated below.

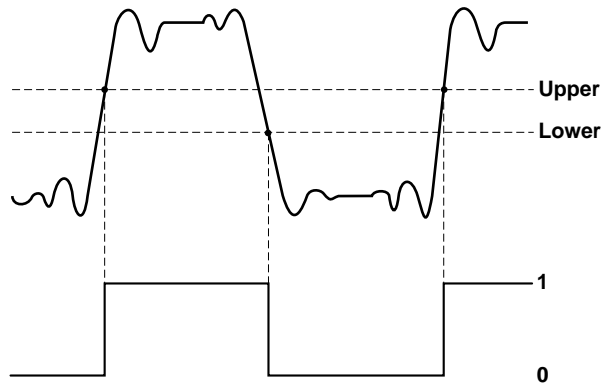

Note

Binary computation is operative on every channel. In addition, a total of eight binary waveforms can be converted back to analog waveforms. For details refer to page 9-15.

Operating Procedure

Selecting the computation mode

1. Press the **MATH** key.
2. Press the “**Mode**” soft key to display the math menu.
3. Keep pressing the “**Mode**” soft key until “**Basic**” is selected.

Setting the binary computation type

4. Press the “**Math1**” or “**Math2**” soft key to display the corresponding math menu.
5. Press the same soft key to select one of the choices “**Bin(C1)**” to “**Bin(M1)**”.

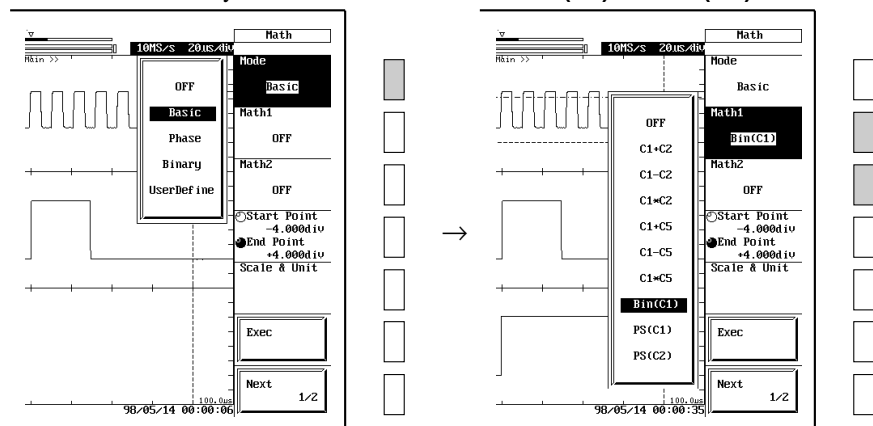

Setting the threshold

6. Press the “Next” soft key to display the “Next 2/2” menu.
7. Press the “Threshold Trace” soft key to select the channel for which the threshold is to be set.
8. Press the “Threshold Up” soft key.
The upper threshold level can now be set using the jog shuttle.
9. Turn the jog shuttle to set the upper threshold level (High).
10. Repeat the above steps to set the lower threshold level (Low).

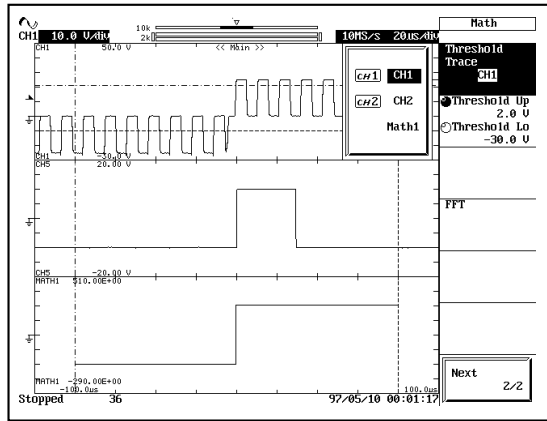

9.6 Phase Shifted Addition, Subtraction and Multiplication

Function

This function lets you shift the waveform from one channel (phase shift) and then add, subtract, or multiply the shifted waveform against the waveform on another channel. Channel allocations are as follows.

Math1 (Phase) CH1 and CH2; or CH1 and CH5

Math2 (Phase) CH1 and CH3; or CH1 and CH7

Note

Addition and subtraction types differ from those available in basic mode (page 9-10).

Allowable shifting range

You can phase-shift the waveform up to half the record length (record-length/2) in either direction along the time axis, in steps of $\{1/\text{sample-rate}\}$. For information about the relation between sample rates, record lengths, and T/div settings, see Appendix 1.

Points for attention when phase shifting

If T/div is changed after shifting the phase, the amount of the shift does not change on the screen, and T/div changes with the set time value.

Operating Procedure

Selecting the computation mode

1. Press the **MATH** key.
2. Press the “**Mode**” soft key to display the math menu.
3. Keep pressing the “**Mode**” soft key until “**Phase**” is selected.

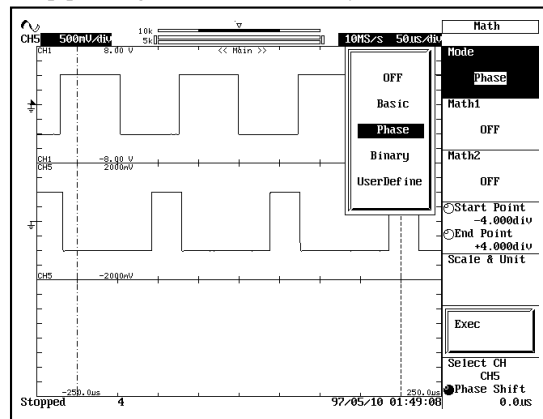

Setting the addition and subtraction type

4. Press the “Math1” or “Math2” soft key to display the Math1 menu.
5. Press the same soft key again to select the desired type.

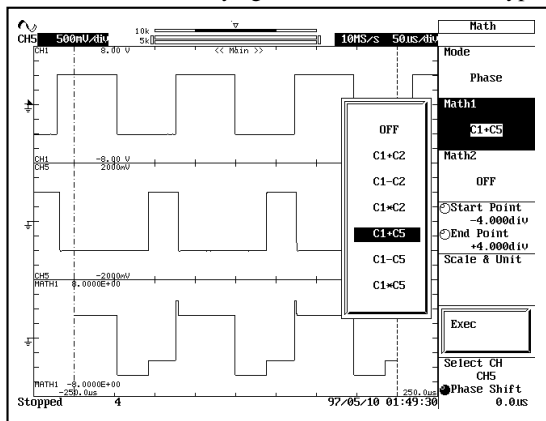

Setting the phase shift

6. Press the “Select CH” soft key as necessary to select the channel to be shifted.
7. Turn the jog shuttle to set the phase shift.

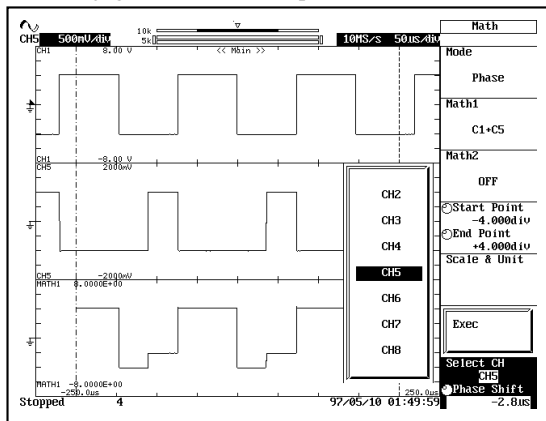

9.7 Simultaneous Binary Computation and D/A Conversion of All Channels

Function

Simultaneous binary computation on all channels

Binary computation can be performed on all channels simultaneously.

Binary computation cannot be performed on inputs from the following types of channels. The computed waveforms of these channels are not displayed.

- Logic input channels
- Channels which do not have an input module installed
- Channels which can not be used due to the record length setting

D/A conversion of binary waveforms

A total of eight binary waveforms can be converted into a single analog waveform. CH1 to CH8 are assigned to carry bits 0 to 7 of the analog waveform.

For the following types of input channels, all data are binary computed to 0 and D/A converted.

- Logic input channels
- Channels which do not have an input module installed
- Channels which can not be used due to the record length setting

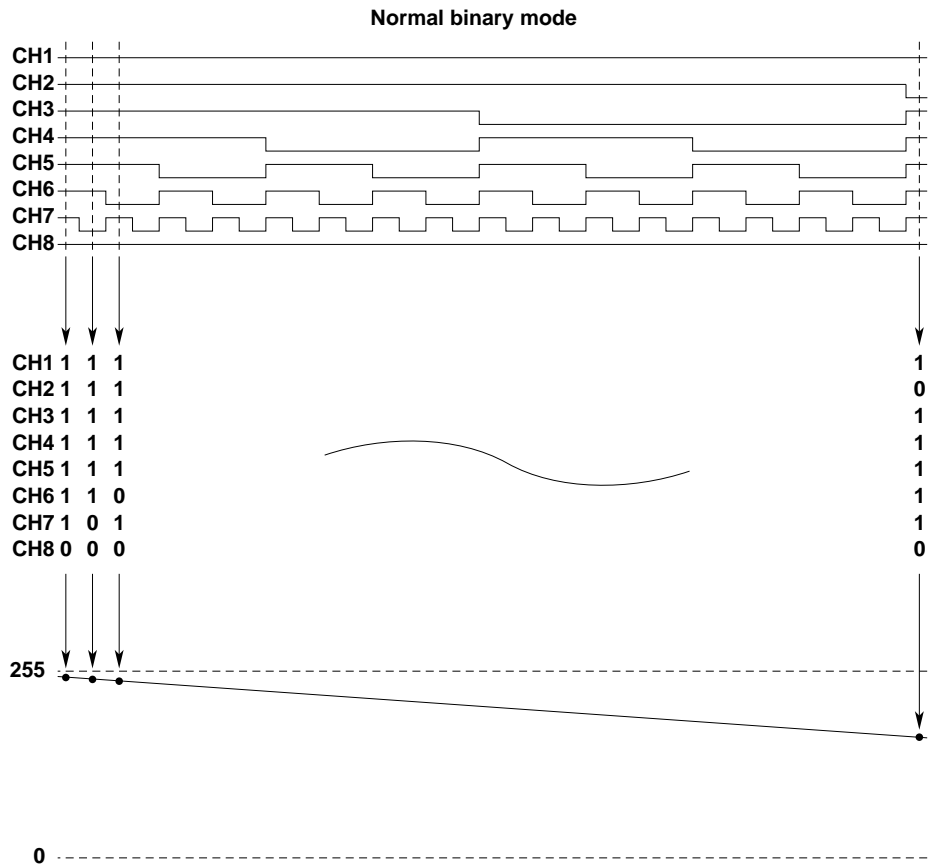

D/A conversion mode

Two D/A conversion modes are available: normal binary mode and complement display mode. The difference between the two modes for binary to decimal conversion is shown below .

| NORMAL | | | | | | | | | COMPLE | | | | | | | | |
|--------|---|---|---|---|---|---|---|-------|--------|---|---|---|---|---|---|---|--------|
| CH1 | 2 | 3 | 4 | 5 | 6 | 7 | 8 | | CH1 | 2 | 3 | 4 | 5 | 6 | 7 | 8 | |
| 1 | 1 | 1 | 1 | 1 | 1 | 1 | 1 | → 255 | 0 | 1 | 1 | 1 | 1 | 1 | 1 | 1 | → 127 |
| 1 | 0 | 0 | 0 | 0 | 0 | 0 | 0 | → 128 | 0 | 0 | 0 | 0 | 0 | 0 | 0 | 0 | → 0 |
| 0 | 1 | 1 | 1 | 1 | 1 | 1 | 1 | → 127 | 1 | 1 | 1 | 1 | 1 | 1 | 1 | 1 | → -1 |
| 0 | 0 | 0 | 0 | 0 | 0 | 0 | 0 | → 0 | 1 | 0 | 0 | 0 | 0 | 0 | 0 | 0 | → -128 |

Operating Procedure

Selecting the computation mode

1. Press the **MATH** key.
2. Press the **Mode** soft key to display the math menu.
3. Keep pressing the **Mode** soft key until **Binary** is selected.

Setting the simultaneous binary computation type

4. Press the **Math1** soft key to select **State**.

Setting the threshold level for each channel (Math1 only)

5. Press the **Next 1/2** soft key.
6. Press the **Threshold Trace** soft key to display the threshold level channel menu.
7. Keep pressing the **Threshold Trace** soft key to select one of the channels from **CH1** to **CH8**.

Channels which do not have input modules installed are not displayed on the menu.

8. Press the **Threshold Up/Threshold Lo** soft key.
The upper threshold level can now be set using the jog shuttle.
9. Turn the jog shuttle to set the upper threshold level (High).
10. Repeat the above steps to set the lower threshold level (Low).
11. Repeat steps 6 to 10 until the threshold level has been set for all desired channels.

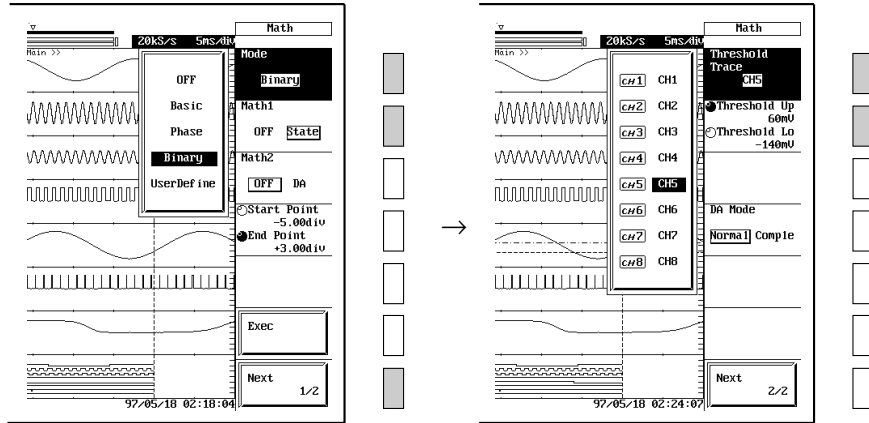

Setting the D/A conversion computation

4. Keep pressing the **Math2** soft key until **DA** is selected.

Selecting the D/A conversion method

5. Press the **Next** soft key to display the **Next 2/2** menu.
6. Press the **DA Mode** soft key to select either **Normal** or **Comple**.

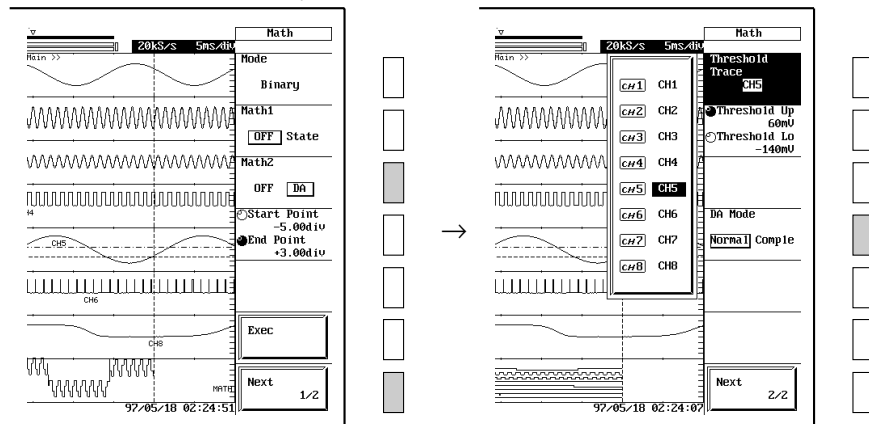

9.8 Displaying Power Spectrums

≡ For a description of this function, refer to page 1-21. ≡

Function

This function displays the power spectrum of the waveform on CH1/2/5.

Math1(Basic) : PS(C1), PS(C2)

Math2(Basic) : PS(C5)

If CH1/2/5 is set to logic input, however, the power spectrum is not displayed.

Points

Select 1000, 2000, or 10000.

The instrument applies FFT to the selected number of points (beginning at the specified Start Point) to generate the power spectrum.

Window

Selects the time window. Select either of the following.

Rect : Rectangular window; useful for transient signals that attenuate completely within the window.

Hanning : Useful for continuous but nonperiodic signals.

Flattop : The frequency resolution drops as compared to the Hanning window, but is effective in increasing the level accuracy.

Restrictions

- This function does not operate while the instrument is in envelope mode.
- If the display record length is less than the selected number of points for the computation, this operation cannot be executed.
- If the number of points is set to 10000, Math2 cannot be used.
- If the bandwidth limit is set to Auto on the High-Resolution, High-Voltage, Isolation/High-Resolution, Isolation Modules, the anti-aliasing filter becomes active.
- The horizontal axis of the FFT displays half of the frequencies of the sampling rate (or data update rate) of each module as defined by the Nyquist Theorem. For example, if the measurements are made at 10 MS/s and 100 kS/s, the frequencies become 5 MHz and 50 kHz, respectively. However, if modules with different maximum sampling rates (or data update rates) coexist and if the measurement is made at frequencies higher than the maximum sampling rate of some modules, the data for those modules will not be displayed correctly. In this case aliasing occurs in which the low frequency data are displayed in the high frequency region. Please be aware that the display that results from aliasing does not reflect the actual signal.

Operating Procedure

1. Press the **MATH** key.
2. Press the “**Mode**” soft key as necessary to select “**Basic**.”
3. Press the “**Math1**” soft key and select “**PS(C1)**” or “**PS(C2)**,” or press the “**Math2**” soft key and select “**PS(C5)**.”
4. Press the “**Next**” soft key to display the “**Next 2/2**” menu.
5. Press the “**FFT**” soft key to open the Select menu.
6. Turn the jog shuttle to move the cursor to the “**Points**” item, and then press the **SELECT** key as necessary to select the number of points.
7. Turn the jog shuttle again to move the cursor to the “**Window**” item. Press the **SELECT** key to choose the window.

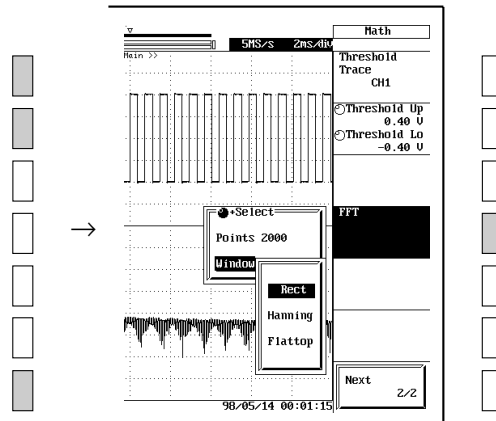
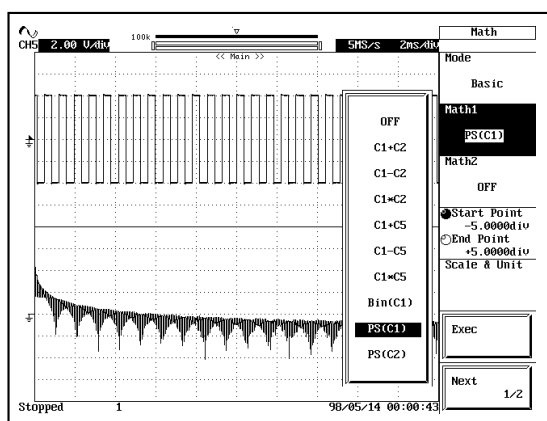

9.9 Manual Scaling

≡ For a description of this function, refer to page 1-20. ≡

Function

Normally, the computed waveform is displayed using auto scaling according to the results of the computation. Using manual scaling, you can set the upper and lower limit values of the computed waveform display to any desired value.

The following computed waveforms cannot be manually scaled.

- Waveforms of data that are converted to binary values simultaneously on all channels.
- Waveforms of binary data that are D/A converted.

Setting Range

-1.0000E+30 to +1.0000E+30

You can read the auto scaling value by setting the “Scale Value” to ON in the DISPLAY menu.

Operating Procedure

1. Press the **MATH** key.
2. If “User Define” is selected for the “Mode”, display the “Next 2/3” menu. If any other mode is selected display the “Next 1/2” menu.
3. Press the “Scale & Unit” soft key to display the scaling value setting menu.
4. Move the cursor to “Mode” with the jog shuttle.
5. Press the **SELECT** key to select “Manual”.

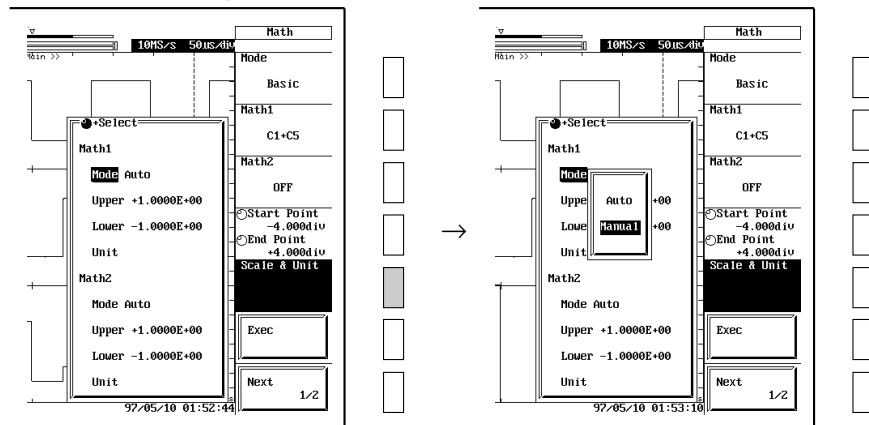

6. Turn the jog shuttle to move the cursor to “Upper” under “Math1”, and press the **SELECT** key to display the menu for setting the value.
7. Set the upper limit value with the jog shuttle.
8. Similarly, set the lower limit value at “Lower”.
9. As necessary, repeat steps 4 through 8 to set “Math2”.

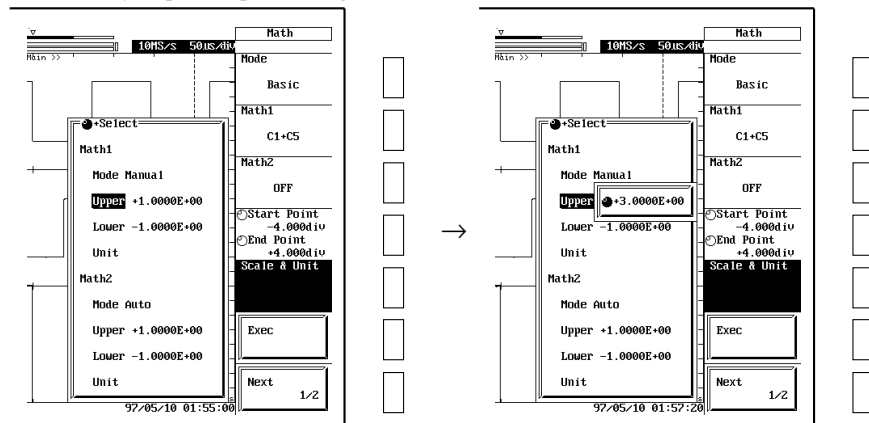

9.10 Executing User Defined Computation (Optional)

=For a description of this function, refer to page 1-22.=

Function

The following operators can be combined to make computations.

Available operators

| Operator | Example | Description |
|----------|------------------|---|
| +,-,X,/ | C1+C2 | Display the arithmetic operation of the specified waveform |
| ABS | ABS(M1) | Display the absolute value of the specified waveform |
| SQR | SQR(C2) | Display the square root of the specified waveform |
| LOG | LOG(C1) | Display the logarithm of the specified waveform |
| EXP | EXP(C1) | Display the exponent of the specified waveform |
| BIN | BIN(C1) | Display the binary computation of the waveform |
| PWHH | PWHH(M1) | Display the pulse width computation from the rising edge to the next rising edge |
| PWHL | PWHL(C2) | Display the pulse width computation from the rising edge to the next falling edge |
| PWLH | PWLH(C1) | Display the pulse width computation from the falling edge to the next rising edge |
| PWLL | PWLL(C1) | Display the pulse width computation from the falling edge to the next falling edge |
| PWXX | PWXX(C2) | Display the pulse width computation from the rising/falling edge to the next rising/falling edge. |
| SIN | SIN(T) | Display the sine of the specified waveform |
| COS | COS(C1) | Display the cosine of the specified waveform |
| TAN | TAN(C1) | Display the tangent of the specified waveform |
| ATAN | ATAN(C1,C2) | Display the arc tangent of the 2 specified waveforms (value within $\pm\pi$) |
| MEAN | MEAN(C1) | Display the 10-order moving average of the specified waveform |
| DIF | DIF(C1) | Display the derivative of the specified waveform |
| DDIF | DDIF(C1) | Display the 2nd order derivative of the specified waveform |
| INTG | INTG(C1) | Display the integral of the specified waveform |
| IINTG | IINTG(C1) | Display the double integral of the specified waveform |
| PH | PH(C1,C2) | Display the phase difference between the 2 specified waveforms |
| HLBT | HLBT(C1) | Display the Hilbert function of the specified waveform |
| P2 | P2(C1) | Display the square of the specified waveform |
| P3 | P3(C1) | Display the cube of the specified waveform |
| FILT1 | FILT1(C1) | Pass the specified waveform through the filter and display |
| FILT2 | FILT2(C1) | Pass the specified waveform through the filter and display |
| LS- | LS-REAL(C1) | Display the real part of the linear spectrum of the specified waveform |
| | LS-IMAG(C1) | Display the imaginary part of the linear spectrum of the specified waveform |
| | LS-MAG(C1) | Display the magnitude of the linear spectrum of the specified waveform |
| | LS-PHASE(C1) | Display the phase of the linear spectrum of the specified waveform |
| | LS-LOGMAG(C1) | Display the logarithm magnitude of the linear spectrum of the specified waveform |
| RS- | RS-MAG(C1) | Display the magnitude of the rms value spectrum of the specified waveform |
| | RS-LOGMAG(C1) | Display the logarithm magnitude of the rms value spectrum of the specified waveform |
| PS- | PS-MAG(C1) | Display the magnitude of the power spectrum of the specified waveform |
| | PS-LOGMAG(C1) | Display the logarithm magnitude of the power spectrum of the specified waveform |
| PSD- | PSD-MAG(C1) | Display the magnitude of the power spectrum density of the specified waveform |
| | PSD-LOGMAG(C1) | Display the logarithm magnitude of the power spectrum density of the specified waveform |
| CS- | CS-REAL(C1,C2) | Display the real part of the cross spectrum of the 2 specified waveforms |
| | CS-IMAG(C1,C2) | Display the imaginary part of the cross spectrum of the 2 specified waveforms |
| | CS-MAG(C1,C2) | Display the magnitude of the cross spectrum of the 2 specified waveforms |
| | CS-PHASE(C1,C2) | Display the phase of the cross spectrum of the 2 specified waveforms |
| | CS-LOGMAG(C1,C2) | Display the logarithm magnitude of the cross spectrum of the 2 specified waveforms |
| TF- | TF-REAL(C1,C2) | Display the real part of the transfer function of the 2 specified waveforms |
| | TF-IMAG(C1,C2) | Display the imaginary part of the transfer function of the 2 specified waveforms |
| | TF-MAG(C1,C2) | Display the magnitude of the transfer function of the 2 specified waveforms |
| | TF-PHASE(C1,C2) | Display the phase of the transfer function of the 2 specified waveforms |
| | TF-LOGMAG(C1,C2) | Display the logarithm magnitude of the transfer function of the 2 specified waveforms |
| CH- | CH-MAG(C1,C2) | Display the magnitude of the coherence function of the 2 specified waveforms |
| K1 to K5 | C1+K1 | 5 constants from K1 to K5 can be defined for use. |
| F1 | F1(C1,C2) | Display the result of the expression $\sqrt{C1^2 + C2^2}$ of the 2 specified waveforms.* |
| F2 | F2(C1,C2) | Display the result of the expression $\sqrt{C1^2 - C2^2}$ of the 2 specified waveforms.* |

* This function is available on DL708Es with firmware versions 4.00 or later.

Waveforms/variables that can be computed

CH waveforms (C1 to C8), Math1 waveform (M1), variable T (The total number of data points in the time direction is defined to be T. It is displayed as a rising line on the screen.) However, computation cannot be performed on channels that have logic input modules installed.

Combinations that are not allowed in computing equations

- Math2 can not be placed within Math1.
- Computation containing only constants (K1 to K5) are not allowed.
- Only one FFT operator can be used in an equation.
- Only one pulse width operator can be used in an equation.
- Only two operators can be used in an equation for FILT1 and FILT2.

Digital Filter

There are 3 types of filters as follows.

| Type | Band |
|-------------------|------------------------------|
| Gaussian | Low Pass |
| Sharp | Low Pass/High Pass/Band Pass |
| IIR (Butterworth) | Low Pass/High Pass/Band Pass |

Setting range of the cutoff frequency: 2.0% to 30.0% of the sampling rate (in 0.2% steps)

Averaging the computed data/computing the peak*

Averaging and peak computation can be performed on the computed data. Four types of operations are available: linear/exponential/cycle/peak.

For linear averaging, set the average count (acquisition count, 2 to 128, in 2ⁿ steps). For exponential averaging, set the attenuation constant (2 to 256, in 2ⁿ steps).

Make sure to specify which waveform, time axis waveform or frequency waveform, to take the average. Specifying a wrong waveform will give a meaningless result.

For cycle averaging, set the number of data points of one cycle (Cycle Count) in the range, 10 to 1000. This number is applied to the data from the start to the end of the computed data, but the remaining data that cannot be divided by the “Cycle Count” are ignored.

For peak computation, the maximum value at each point of the computed data are determined and the waveform is displayed. For each computation, the new computed value is compared with the past value and the larger value is kept.

Example of cycle averaging

When the record length is 10 k, the “Cycle Count” is 720, the start point of computation is -5.000 div, and the end point is +5.000 div.

$$10\text{ k}/720 = 13.88 \text{ 13 cycles will be averaged.}$$

$$13 \times 720 = 9360 \text{ Data between the start point to the 9360th point will be cycle averaged.}$$

• Precautions on averaging computed data/peak computation

The auto scaling is defined for the 1st computed waveform.

If you would like to obtain a computed waveform whose amplitude varies significantly after averaging (e.g. Coherent function), please set the manual scaling.

For details on the manual scaling, refer to “9.9 Manual Scaling.”

* This function is available on DL708Es with firmware versions 3.00 or later.

Constants

Constants can be set in the range from -1.0000E+30 to 1.0000E+30.

Computing range and display units

For details regarding the computing range and the display units of the math waveform, refer to Section 9.3 “Setting Computing Range and Display Units, and Recomputing.”

Threshold level of binary computation

With binary computation, the specified waveform (CH1 to CH8, Math1) is converted to a digital waveform of “0” and “1” with respect to the threshold level (Upper, Lower).

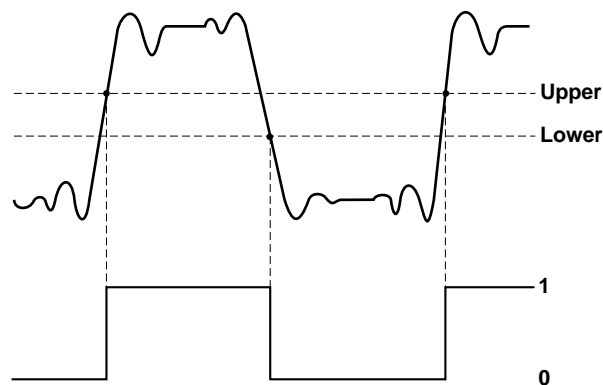

The allowable range for the threshold level varies depending on the specified waveform as shown below.

Channel waveform: 8 div within the display screen (setting resolution is 0.1 div)

Math1 waveform: -1.0000E+30 to 1.0000E+30

FFT

For a description of the FFT, refer to points, FFT frequency band, and window in Section 9.8 “Displaying Power Spectrums.”

For details on digital filters and the FFT, refer to Appendix 6.

Operating Procedure

1. Press the “**MATH**” key.
2. Press the “**Mode**” soft key several times to select “**UserDefine.**”

User define the computing equation

3. Press the “**Expression Math1**” or “**Expression Math2**” soft key to display the keyboard.
4. Input the computing equation. For information on how to input character strings, refer to Section 4.1 “Entering Values and Character Strings”.

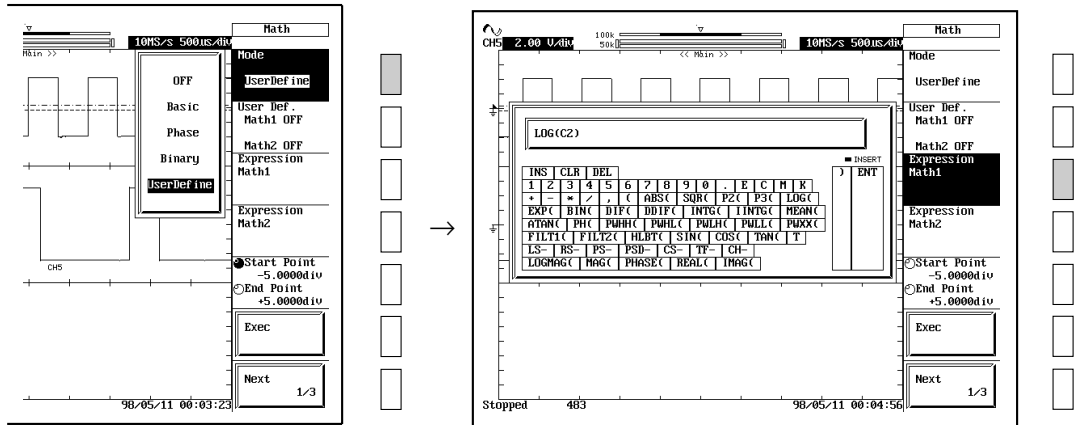

Displaying math waveforms

5. Press the “**User Def.**” soft key to display the math waveform display **ON/OFF** menu.
6. Turn the jog shuttle to move the cursor to Math1 and press **SELECT** to turn it **ON**. Set Math2 similarly.

Setting the computing range and units

Refer to Section 9.3 “Setting Computing Range and Display Units, and Recomputing”.

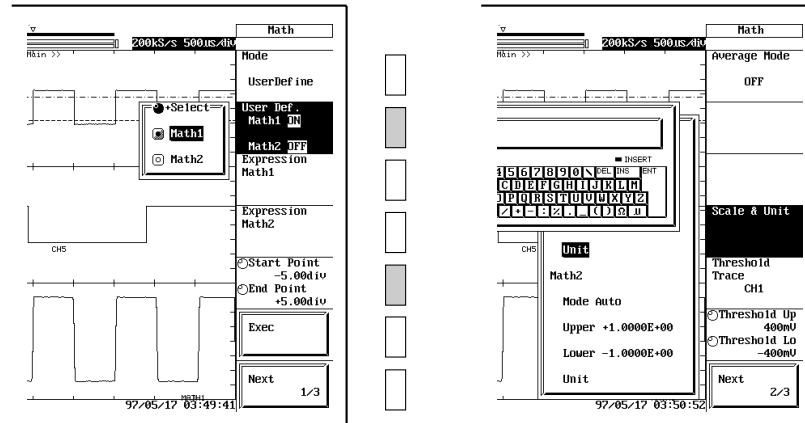

Note

If you changed the start point of computation or changed the computing range, recompute. For details on recomputing, see section 9.3.

Setting the threshold level

If “BIN” or pulse width computation is specified in the computing equation, set the threshold level with the jog shuttle.

7. Press the “Next” soft key to display the “Next 2/3” menu.
8. Press the “Threshold Trace” soft key to select the trace to set the threshold.
9. Press the “Threshold Upper” soft key.
The jog shuttle now controls the “Threshold Upper” setting.
10. Set the Upper level with the jog shuttle.
11. Set the “Threshold Lower” similarly.

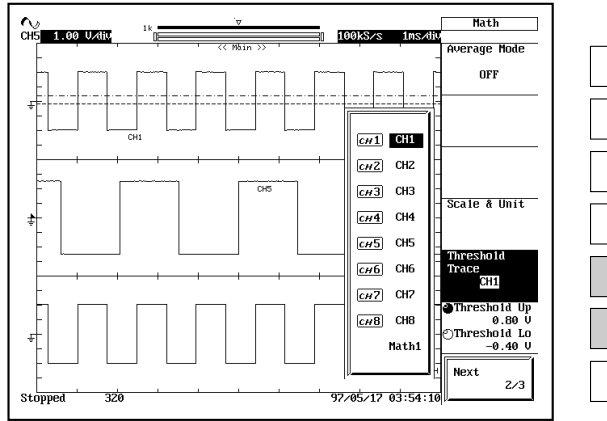

Digital filter

If “FILT1” or “FILT2” is specified in the computing equation, set the digital filter.

7. Press the “Next” soft key to display the “Next 3/3” menu.
8. Press the “Filter Select” soft key to select “FILT1” or “FILT2”.
9. Press the “Filter Type” soft key several times to select “Gauss”, “Sharp” or “IIR”.
10. Press the “Filter Band” soft key to select “Low-Pass”, “High-Pass” or “Band-Pass”.
11. Turn the jog shuttle to set the cutoff frequency. If “Band-Pass” is selected for the band, you will set both High and Low cutoff frequencies.
Press the “Cutoff1/Cutoff2” soft key to set the jog shuttle control to Cutoff1 or Cutoff2, and then set the value.

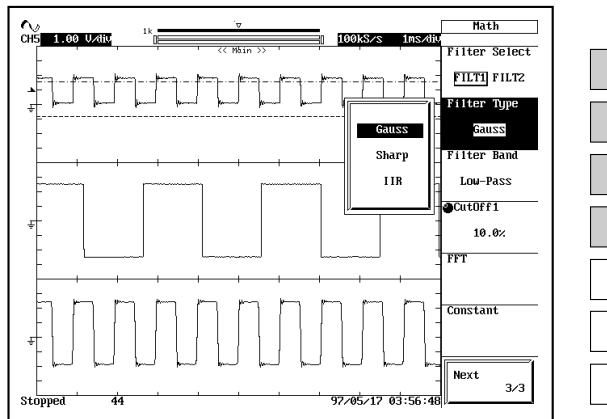

Setting the number of points for the FFT and the time window

If “FFT” is specified in the computing equation, set the following settings.

7. Press the “Next” soft key to display the “Next 3/3” menu.
8. Press the “FFT” soft key to display the number of computing points/time window selection menu.
9. Turn the jog shuttle to move the cursor to the “Points” item and press the **SELECT** key several times to select the number of points.
10. Turn the jog shuttle to move the cursor to the “Window” item and press the **SELECT** key to choose the window.

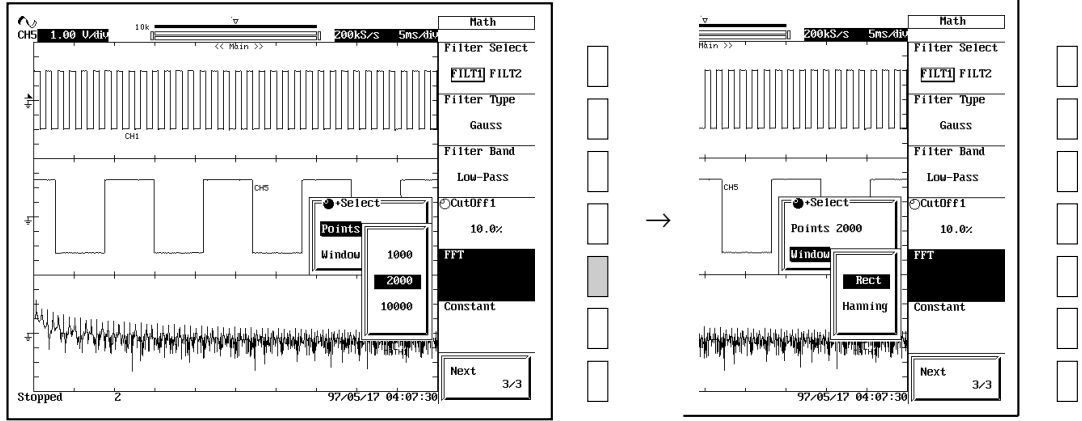

Setting constants K1 to K5

7. Press the “Next” soft key to display the “Next 3/3” menu.
8. Press the “Constant” soft key to display the constants setting menu.
9. Turn the jog shuttle to move the cursor to the constant you wish to set, then press the **SELECT** key to display a menu for setting the value.
10. Set the value with the jog shuttle.
Use the arrow keys to move from one digit to the next.

Setting the averaging of the computed data/peak computation

7. Press the “Next” soft key to display the “Next 2/3” menu.
8. Press the “Mode” soft key and select “Linear,” “Exp,” “Cycle,” or “Peak.”
If you selected “Peak,” the operating procedure ends here.

If “Linear” or “Exp” was selected

9. Press the “Average Domain” soft key and select “Time” or “Freq.”
10. Turn the jog shuttle to set the “Linear Count” (average count) or the “Exp Weight” (attenuation constant.)

If “Cycle” was selected

9. Turn the jog shuttle to set the “Cycle Count” (number of data points of one cycle.)

Setting of constants

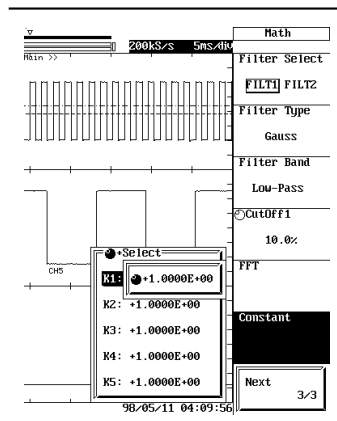

Setting of averaging

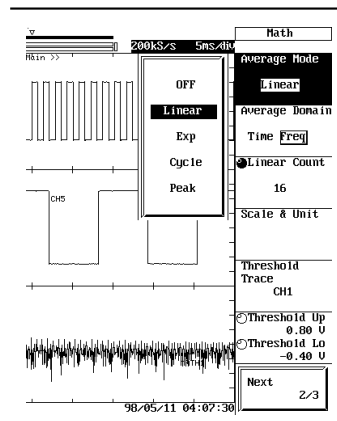

10.1 Loading Paper Roll in Printer

Printer Roll Chart

Use only YOKOGAWA's roll charts. When you are using the printer for the first time, use the roll chart supplied with the instrument. When your roll charts have run out, purchase more from your dealer or YOKOGAWA sales offices listed on the back cover of this manual.

Part No. : B9850NX
Specification : Thermo-sensible, 30 m
Minimum quantity : 5 rolls

Handling the Roll Chart

Thermosensible roll charts produce color using a thermal reaction, therefore the following precautions must be taken.

Storage precautions

The roll chart begins to develop color at approximately 70°C. It is very sensitive to heat, damp, light and chemicals both before and after use.

- Keep roll charts in a dry, cool and dark place.
- Once the package is opened, use the roll chart as soon as possible.
- If the roll chart is left in contact with plastic films containing plasticizer (for instance, vinyl chloride film, cellophane tape etc.) for a long period of time, discoloration will occur on the recording area of the chart due to the plasticizer. If you are going to keep the roll chart in a holder, for instance, use a polypropylene holder.
- When you use adhesive on the roll chart, never use adhesive which contains an organic solvent such as alcohol or ether, otherwise color may develop on the chart.
- When you are going to store recorded roll charts for a long period of time, we suggest you make a copy of the charts since discoloration may occur.

Usage precautions

- Use only YOKOGAWA's genuine roll charts.
- Do not touch the roll chart with sweaty hands, otherwise it may become stained with your fingerprints, and information may be lost.
- Do not rub the surface of the roll chart strongly with a firm object, color development may occur due to frictional heat.
- Do not allow chemicals or oil to come into contact with the roll chart, otherwise color development or loss of information may result.

Operating Procedure

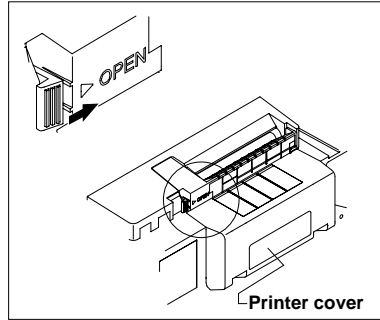

Raise the handle to the upright position and push the “III” mark on the printer cover located on the top section of the rear panel towards the letters “OPEN.” The cover opens slightly. Pull the cover open.

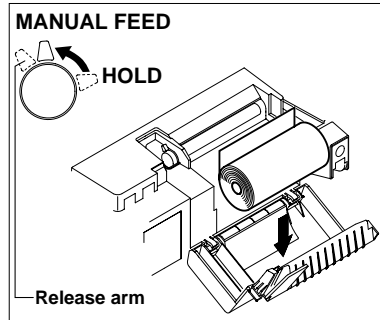

Move the release arm located on the left side looking towards the rear panel, to the “MANUAL FEED” position. Turn the roll paper so that the inner side (side that is not glossy) can be seen on top and place it in the holder.

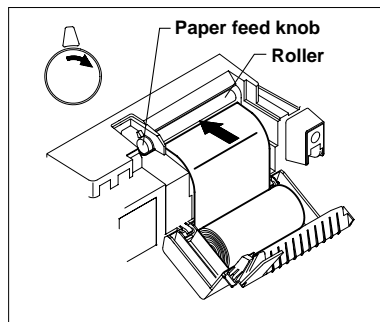

Insert the edge of the roll paper uniformly in the space between the roller and the black guide. Rotate the paper feed knob toward you until 10 cm of the edge of the roll paper is showing from the top of the roller.

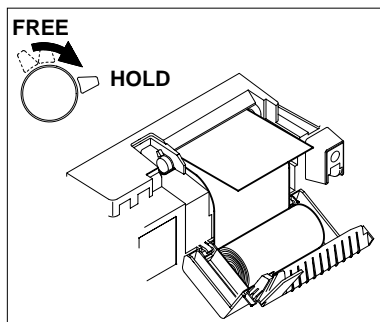

Move the release arm to the “FREE” position and adjust the roll paper so that there are no twists or bents. Then, move the release arm to the “HOLD” position. Printing with the release arm in the “FREE” or “MANUAL FEED” position displays an error message. You cannot print in this condition.

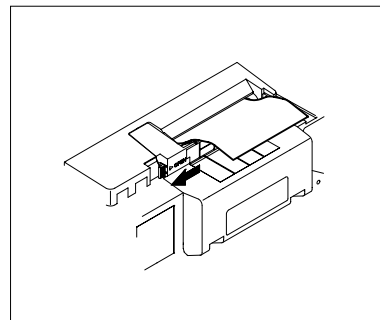

Push the printer cover towards the back and close it. Make sure the edge of the roll paper is showing at the paper exit section of the printer cover. Close the cover firmly until it clicks and the “III” mark is set to the left side.

Note

After installing the roll chart, make sure that the chart is feeding properly according to the steps given on the next page. If the roll chart does not feed straight, continue to feed the paper for about 30 cm. It should straighten itself out.

10.2 Feeding the Chart

Function

The roll chart can be fed to check whether the chart has been loaded properly or to skip dirty sections.

Points for attention

The roll chart cannot be fed during acquisition.

Operating Procedure

1. Press the **SHIFT** key.
Functions marked in purple on the panel are now operative.
2. Press the **COPY** key.
3. Press the “**Copy to**” soft key to display the output media menu.
4. Keep pressing the “**Copy to**” soft key until “**Printer**” is selected.
5. Press the “**Paper Feed**” soft key. Paper feed will start.

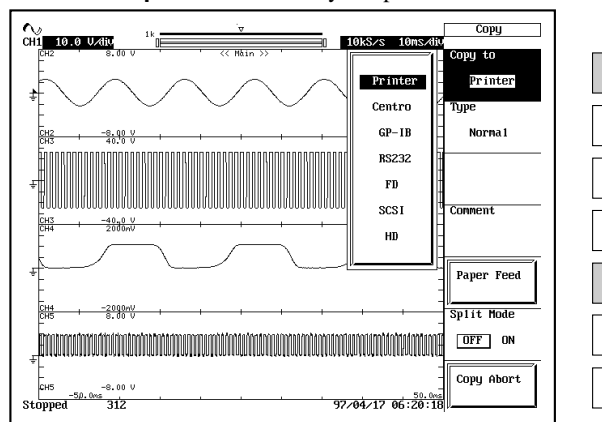

10.3 Outputting to Printer

Function

Output type

Following three output types are available for printing to the built-in printer.

- Normal : The display screen is printed in normal size. Split Mode settings cannot be made.
- Long : Enlarge the waveform displayed on the screen by a factor of 2 to 50 taking 10 div on the time axis to be one page and print (long copy)

The following magnifying factors are available. Depending on the T/div setting, the factor becomes the value indicated in ().

- $\times 2$ (2.5), $\times 5$ (4), $\times 10$, $\times 20$ (25), $\times 50$ (40)
- All : When the display record length is shorter than the record length, the display record length is taken to be one screen. The number of screens equivalent to (record length \div display record length) is output. Split mode settings cannot be made.

Split print ON/OFF

When this is turned "ON" when each waveform is displayed in its separate window, each window is zoomed in the vertical direction and printed as a full page. The printing is repeated for every split window. This is useful when the waveform becomes too small because there are too many split displays.

Comment

By entering a comment string using up to 30 characters and displaying it on the bottom section of the screen, it can be printed at the time of the print.

Points for attention

- No data can be output to the printer during acquisition.
- When both pre-zoom waveform and zoomed waveform are displayed, only the pre-zoom waveform is applicable to long copy.
- When displaying the waveform with the history memory function, only the waveform selected with "Selected Record No." is applicable to long copy.
- Long copy cannot be carried out during X-Y waveform display.

Operating Procedure

Selecting the printer

1. Press the **SHIFT** key. Functions marked in purple on the panel are now operative.
2. Press the **COPY** key.
3. Press the "**Copy to**" soft key to display the output media menu.
4. Keep pressing the "**Copy to**" soft key until "**Printer**" is selected.

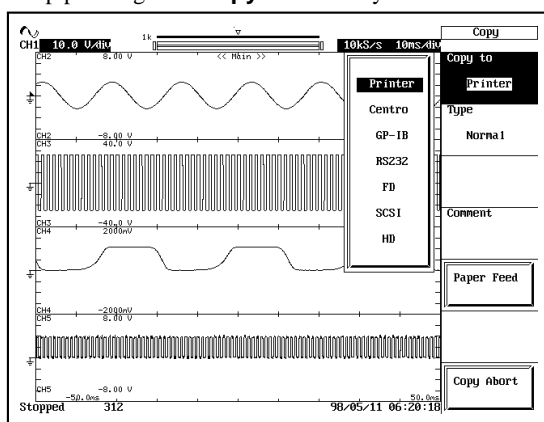

Selecting the output type

5. Press the “**type**” soft key to display the output format menu.
6. Keep pressing the “**type**” soft key to select the desired output type from “**Normal**” to “**Long*50**” or “**All.**”

Split print ON/OFF

7. Press the “**Split Mode**” soft key to select either “**ON**” or “**OFF.**”

Setting the comment

8. Press the “**Comment**” soft key to display the keyboard screen.
9. Enter characters using the procedure described on page 4-1.

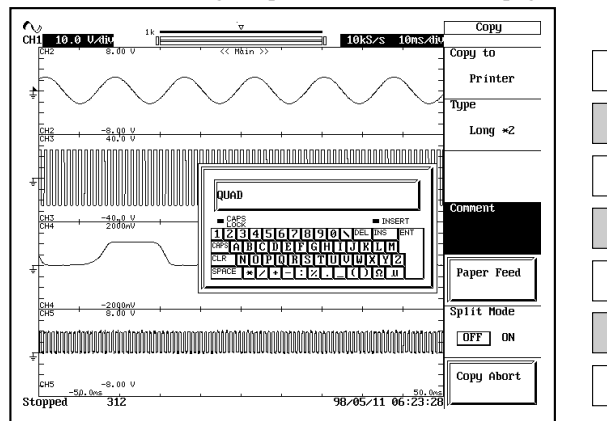

Outputting to the printer

10. Display the screen which you wish to print out.
11. Press the **START/STOP** key to stop acquisition.
If the indicator on the **START/STOP** key is lit, acquisition is in progress.
12. Press the **COPY** key to output a hard copy of the screen data to the printer.
To stop output press the “**Copy Abort**” soft key.

An example of long copy

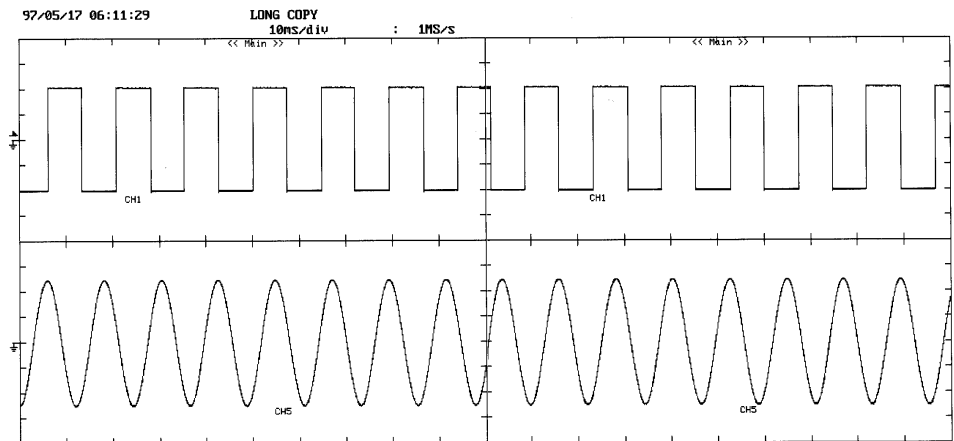

Note

When the printing density exceed 40%, a lighter image may be produced in order to protect the print head.

10.4 Outputting to a Printer with a Centronics Interface

Function

This instrument allows screen image data to be printed to an external printer using the Centronics interface.



CAUTION

- Use the Centronics printer connection cable (B9946YY) to connect the external printer and the instrument. Erroneous connection may damage the instrument or other instruments that are connected.

Centronics Interface Specifications

Pin configuration of Centronics connector

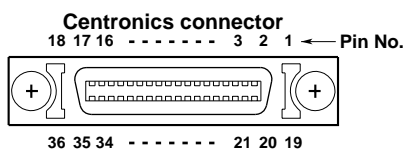

| Pin No. | Signal name | Pin No. | Signal name |
|---------|---------------------------|---------|-------------------------------|
| 1 | STROBE | 19 | GND |
| 2 | DATA0(Print data bit0) | ⋮ | ⋮ |
| ⋮ | ⋮ | 30 | GND |
| 9 | DATA7(Print data bit7) | 31 | INIT(Initializing of printer) |
| 10 | ACK(Acknowledge) | 32 | NC(No connection) |
| 11 | BUSY | 33 | GND |
| 12 | NC(No connector) | 34 | * |
| 13 | SLCT(Select) | 35 | * |
| 14 | AFDXT(Auto feed transfer) | 36 | SLCTIN(Select in) |
| 15 | NC(No connection) | | |
| 16 | GND | | |
| 17 | GND | | |
| 18 | NC(No connection) | | |

* Used for other purposes

Output type

Following three output types are available for printing to the external printer.

- Normal : Print the display screen in regular size
- Long : Enlarge the waveform displayed on the screen by a factor of 2 to 50 taking 10 div on the time axis to be one page and print (long copy)

The following magnifying factors are available. Depending on the T/div setting, the factor becomes the value indicated in ().

× 2 (2.5), × 5 (4), × 10, × 20 (25), × 50 (40)

- All : When the display record length is shorter than the record length, the display record length is taken to be one screen. The number of screens equivalent to (record length ÷ display record length) is output. When ALL is selected, the Split setting is invalid.

External printer type: Format

The following types of output command to the external printer are available.

- ESC-P
- PCL5
- LIPS3
- BJ (Can be used on printers supporting BJ native command)
- PR201 (PC-PR201)
- ESC-P2 (Can be used on printers supporting ESC/P raster commands)

Half tone

Available when the output command type is set to “ESC-P,” “PCL5,” “BJ,” or “ESC-P2.” If set to ON, the shade of the displayed waveform can be printed in color. If set to “OFF,” gradation is disabled.

Comment

You can enter 20 character comment string on the bottom section of the screen, which will appear on print.

Points for attention

- No data can be output to the printer during acquisition.
- When both pre-zoom waveform and zoomed waveform are displayed, only the pre-zoom waveform is applicable to long copy.
- When displaying the waveform with the history memory function, only the waveform selected with “Selected Record No.” is applicable to long copy.
- Long copy cannot be carried out during X-Y waveform display.

Operating Procedure

1. Press the **SHIFT+COPY** key (MENU).
2. Press the “**Copy to**” soft key to select “**Centro.**”
- Selecting the output type and the printer format**
3. Press the “**Type**” soft key to select the desired output type from “**Normal**” to “**Long*50**” or “**All.**”
4. Press the “**Format**” soft key to select “**ESC-P**” to “**BJ.**”
- Setting comments and half tone**
5. If “**ESC-P,**” “**PCL5,**” “**BJ,**” or “**ESC-P2**” was selected in step 4. Press the “**Half Tone**” soft key and select “**ON(Color)**” or “**OFF.**”
6. Press the “**Comment**” soft key to display the keyboard screen.
7. Enter characters using the procedure described on page 4-2.
- Outputting to the printer with Centronics interface**
8. Display the screen which you wish to print out.
9. Press the **START/STOP** key to stop acquisition.
- If the indicator on the **START/STOP** key is lit, acquisition is in progress.
10. Pressing **COPY** key prints the screen image data.

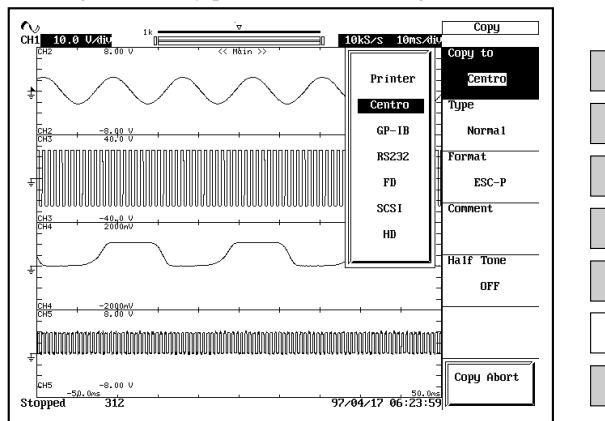

Example of a print out from a printer with Centronics interface (Cannon BJC-240J)

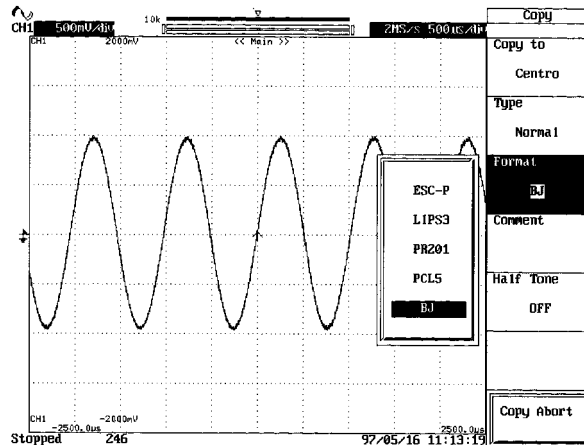

10.5 GP-IB/RS-232 Interface : Data Output and Format Selection

Function

Output data format

Screen data can be output in the following formats to external equipment, such as a personal computer, via the GP-IB interface or the RS-232 interface.

When the output data format is set to HP-GL, the maximum number of waveforms that can be output is 52. Since each Logic Input Module can display up to 16 waveforms, it is possible that some of the logic input waveforms that are displayed might not be output.

Output data format

HP-GL
PostScript
ThinkJet
TIFF
BMP

Half tone

For TIFF and BMP

Waveforms and menus can be output in 16 shades if "ON(Gray)" is selected, or in colors if "ON(Color)" is selected. If "OFF" is selected, no shades will be used.

Comment

A comment of up to 20 characters can be output at the bottom section of the screen.

Data Compression (for TIFF and BMP)

Data of TIFF and BMP formats can be output by compression, using respectively LZW and RLE. If, however, "Half Tone" is set to "OFF", data of BMP format cannot be compressed.

Setting up for output to external plotter

Paper size

A3 or A4

Plotting size

Data is plotted in various sizes as illustrated below. The data size is independent of the paper size. Combining these plotting sizes enables plotting of multiple waveforms on a single piece of paper. The arrows indicate the plotting direction (the arrows face towards the top of the screen.)

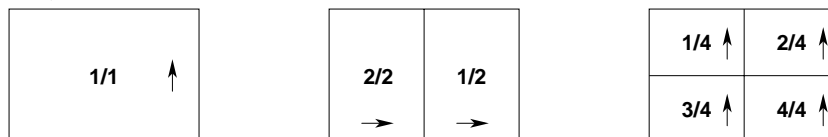

Adjustment of the plotting position

The plotting position can be adjusted. When viewed from the side, the plotting position can be shifted towards the top or right (unit is mm). If the parameter value is negative, the plotting position is shifted towards the bottom or the left. This is independent of the paper size and plot size.

Adjust Top : -99 to 99

Adjust Right : -99 to 99

Pen speed

Normal : Default plotter speed

Low : 10 cm/s

SP0 (Append SP0)

SP0 is an HP-GL command for setting the plotter’s pen. However, with some plotters, this command is sometimes assigned to another function. The SP0 command is sent at the end of data transmission if “Yes” is selected, and no SP0 is sent if “No” is selected. Select either “Yes” or “No,” whichever suits your application. For details refer to the plotter’s User’s Manual.

Measurement dot connection (Dot Connect)

Forced : Connects measured dots and plots them on a graph regardless of the display method.
 Native : Selects whether measured dots are connected or not according to the display method.

Pen assignment

Auto : Assigns pens automatically as follows.

| Installed Pen | Grid | Text | CH1 | CH2 | CH3 | CH4 | CH5 | CH6 | CH7 | CH8 | Math1 | Math2 |
|---------------|------|------|-----|-----|-----|-----|-----|-----|-----|-----|-------|-------|
| 1 | 1 | 1 | 1 | 1 | 1 | 1 | 1 | 1 | 1 | 1 | 1 | 1 |
| 2 | 1 | 1 | 2 | 2 | 2 | 2 | 2 | 2 | 2 | 2 | 2 | 2 |
| 3 | 1 | 1 | 2 | 3 | 2 | 3 | 2 | 3 | 2 | 3 | 2 | 3 |
| 4 | 1 | 1 | 2 | 3 | 4 | 2 | 3 | 4 | 2 | 3 | 4 | 2 |
| 5 | 1 | 1 | 2 | 3 | 4 | 5 | 2 | 3 | 4 | 5 | 2 | 3 |
| 6 | 1 | 1 | 2 | 3 | 4 | 5 | 6 | 2 | 3 | 4 | 5 | 6 |
| 7 | 1 | 1 | 2 | 3 | 4 | 5 | 6 | 7 | 2 | 3 | 4 | 5 |
| 8 | 1 | 1 | 2 | 3 | 4 | 5 | 6 | 7 | 8 | 2 | 3 | 4 |
| 9 | 1 | 1 | 2 | 3 | 4 | 5 | 6 | 7 | 8 | 9 | 2 | 3 |
| 10 | 1 | 1 | 2 | 3 | 4 | 5 | 6 | 7 | 8 | 9 | 10 | 1 |
| 11 | 1 | 1 | 2 | 3 | 4 | 5 | 6 | 7 | 8 | 9 | 10 | 11 |
| 12 | 1 | 1 | 2 | 3 | 4 | 5 | 6 | 7 | 8 | 9 | 10 | 11 |

For example, if Installed Pen = 6, pen 1 is assigned to drawing the grid and pen 2 to drawing CH1.

Manual : Enables you to assign pens as you choose.

Comment

A comment of up to 20 characters can be printed out at the top of the print-out.

Points for attention

- The plotter must be set to listen-only mode before the start of output to the plotter.
- No data can be output to the plotter during acquisition.
- Key operations are still operative during plotting. However, acquisition is not operative until the “Copying” icon disappears.
- When no interpolation is selected, the waveform is plotting without connecting the dots.
- You cannot use halftone storage when outputting in HP-GL format.

Note

- In many cases, connecting the measured dots leads to faster plotting and prolongs the life of the pen.
- Plotting area varies according to machine model. Some models may fail to print some of the data.
- If the specified pens are not present, other pens (of an arbitrary) will be substituted.

Connection Procedure

Connecting the plotter

1. Turn OFF the power to both the instrument and the plotter.
2. Connect the plotter to the instrument using the GP-IB cable or the RS-232 cable.
3. Set the plotter to listen-only mode. (Refer to the plotter manual.)

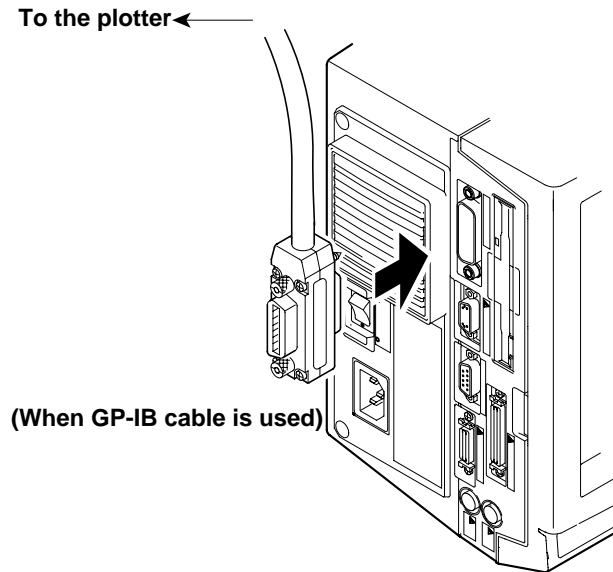

Note

If you start output to the plotter, the instrument will switch to the talk only mode automatically.

Operating Procedure

Selecting the GP-IB mode

1. Press the **SHIFT** key.
Functions marked in purple on the panel are now operative.
2. Press the **COPY** key.
3. Press the “Copy to” soft key to display the output media menu.
4. Keep pressing the “Copy to” soft key until “GP-IB” or “RS232” is selected.

Selecting the output format

5. Press the “Format” soft key to display the output format menu.
6. Keep pressing the “Format” soft key to select “HP-GL” to “BMP.”

Setting the half tone (except for HP-GL format)

7. Press the “Half Tone” soft key to select “ON(Gray),” “ON(Color),” “ON(Color R)” or “OFF.”

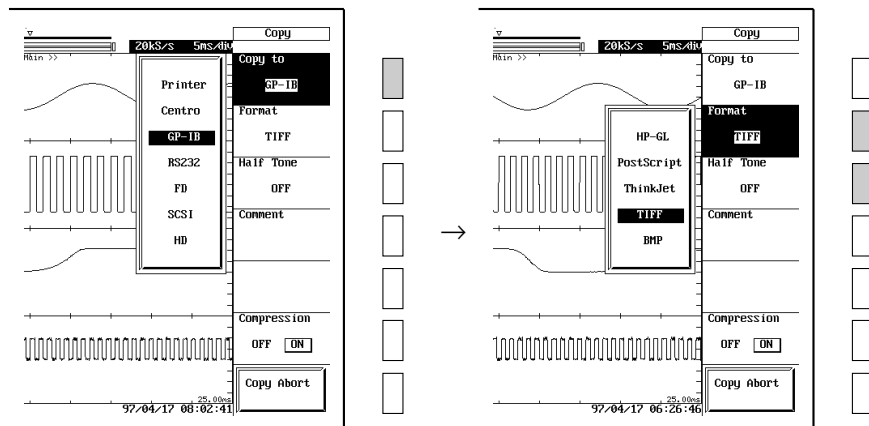

Setting the paper size, plotting size, pen speed and pen assignment (for only HP-GL format)

7. Press the **“Plotter Setup”** soft key to display the plotter setting menu.
8. Turn the jog shuttle to move the cursor to **“Paper Size.”**
9. Press the **SELECT** key to display the paper size menu.
10. Keep pressing the **SELECT** key to select **“A3”** or **“A4.”**
11. In the same way, set the **“Plot Size,” “Pen Speed,” “Dot Connect,” “Adjust Top,” “Adjust Right,” “Append SP0”** and **“Pen Select.”**
12. If **“Pen Select”** has been set to **“Auto,”** select **“Installed Pen”** or assign pens for **“Grid”** to **“Math2”** by turning the jog shuttle (if **“Pen Select”** has been set to **“Manual”**).

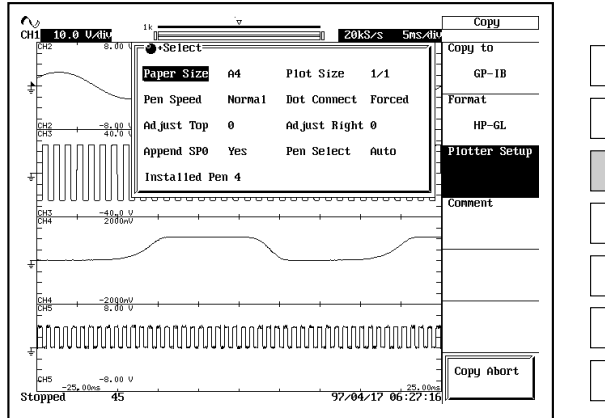

Data compression (with TIFF or BMP only)

13. Press the **“Compression”** soft key to set compression **“ON”** or **“OFF.”**

Setting the comment

14. Press the **“Comment”** soft key to display the keyboard screen.
15. Enter characters using the procedure described on page 4-2.

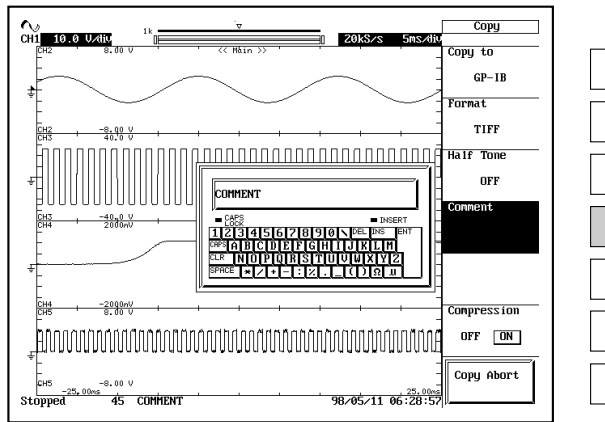

Outputting the screen data

16. Display the desired menu screen.
17. Press the **START/STOP** key to stop acquisition.
If the indicator on the **START/STOP** key is lit, acquisition is in progress.
18. Press the **COPY** key to output a hard copy of the screen data.
To stop output, press the **“Copy Abort”** soft key.

10.6 Outputting to Floppy Disk, Internal Hard Disk (Optional) or External SCSI Device

Function

Output data format

The data can be saved to the specified media in the following formats. The extension identifiers, which are attached automatically, and the file size (when half-tone is OFF) are shown below for your reference.

| Output data format | Extension identifier | File size |
|--------------------|----------------------|-------------------------------------|
| HP-GL | *.HGL | Approx. 60 K bytes (8 channels: ON) |
| PostScript | *.PS | 79,061 bytes (approx. 300 K bytes) |
| ThinkJet | *.TJT | 41,296 bytes |
| TIFF | *.TIF | 38,574 bytes (approx. 300 K bytes) |
| BMP | *.BMP | 38,462 bytes (approx. 300 K bytes) |

The size when half-tone is ON is given in brackets.

Half tone

For TIFF and BMP

Waveforms and menus can be output in 16 shades if “ON(Gray)” is selected or in colors if “ON(Color)” is selected. If “OFF” is selected, no shades will be used.

Comment

A comment of up to 20 characters can be output at the bottom section of the screen.

Data compression (for TIFF and BMP)

Data of TIFF and BMP formats can be output by compression, using respectively LZW and RLE.

Only if “Half Tone” is set to “OFF”, data of BMP format cannot be compressed.

Floppy disk/Internal hard disk/External SCSI device

For details about the disk, refer to Chapter 11. For initialization of a disk, refer also to Chapter 11.

Auto naming function

When “Auto Naming” is set to ON, files are automatically created with 3-digit numbers from “000” to “999.” A common filename (up to 5 characters, specified with Filename) can be inserted before the number.

Operating Procedure

Selecting the medium

1. Press the **SHIFT** key.
Functions marked in purple on the panel are now operative.
2. Press the **COPY** key.
3. Press the “Copy to” soft key to display the output media menu.
4. Keep pressing the “Copy to” soft key until “FD”, “SCSI” or “HD” is selected.

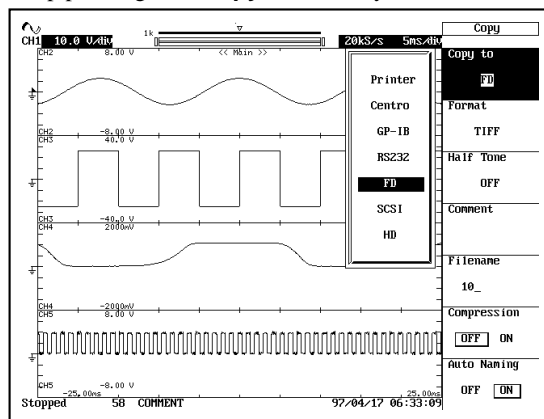

Selecting the output format and setting the half tone (except for HP-GL format)

5. Press the “**Format**” soft key to display the output format menu.
6. Keep pressing the “**Format**” soft key to select the desired output format: “**HP-GL**” to “**BMP.**”
7. Press the “**Half Tone**” soft key to select “**ON(Gray),**” “**ON(Color),**” “**ON(Color R)**” or “**OFF.**”
8. If you have selected the HP-GL format, press the “**Plotter Setup**” soft key and set the paper size and other parameters. (See page 10-11.)

Data compression (with TIFF or BMP only)

9. Press the “**Compression**” soft key to set compression “**ON**” or “**OFF.**”

Setting the comment

10. Press the “**Comment**” soft key to display the keyboard screen.
11. Enter characters using the procedure described on page 4-2.
12. In the same way, enter the file name.
13. Press the “**Auto Naming**” soft key to select “**ON**” or “**OFF.**”

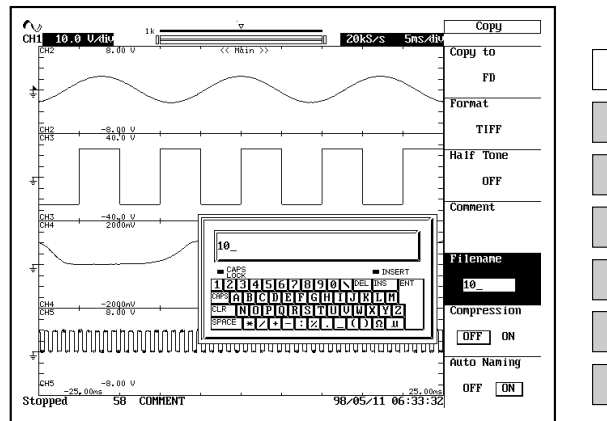

Saving to a medium

14. Display the desired menu screen.
15. Press the **START/STOP** key to stop acquisition.
If the indicator on the **START/STOP** key is lit, acquisition is in progress.
16. Press the **COPY** key to save the data to the medium.
To stop saving, press the “**Copy Abort**” soft key.

Note

You cannot use halftone storage when outputting in HP-GL format.

11.1 Floppy Disks

Types of floppy Disk which can be used

The following types of 3.5-inch floppy disks can be used. Floppy disks can also be formatted using this instrument.

2HD type : MS-DOS format, 1.2 MB or 1.44 MB

2DD type : MS-DOS format, 640 KB or 720 KB

Inserting a Floppy Disk into the Drive

Hold the floppy disk with the label in direction display screen, then insert it into the floppy drive. Insert it until the eject button pops up.

Removing the floppy disk from the drive

Make sure that the access indicator is not lit, then push the eject button.

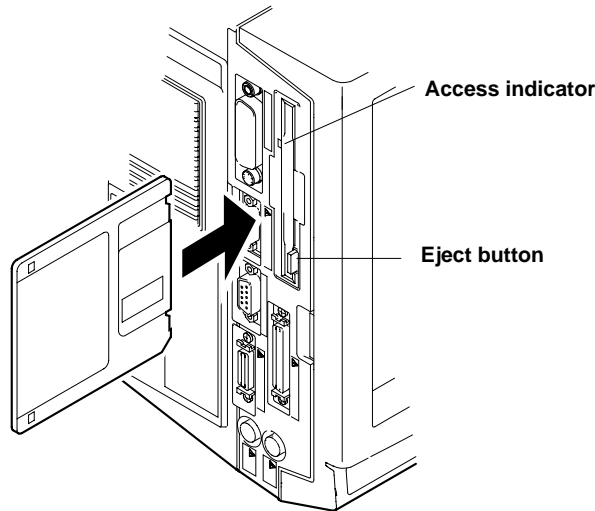

CAUTION

Never remove the floppy disk while the access indicator is lit, or damage to the magnetic head of the drive or loss of data on the floppy disk may result.

General Handling Precautions

For general handling precautions, refer to the instructions supplied with the floppy disk.

11.2 Internal Hard Disk (Optional)



CAUTION

When using the instrument in an environment having vibration, turn OFF the power of the internal hard disk.

Function

The power of the internal hard disk can be turned ON/OFF on this instrument. The internal hard disk can be protected from the vibration by turning the power OFF.

Operating Procedure

1. Press the **MISC** key.
2. Press the **Next** soft key to display the **Next 2/2** menu.
3. Press the **Others** soft key.
4. Press the **HDD Motor** soft key and select **ON** or **OFF.**

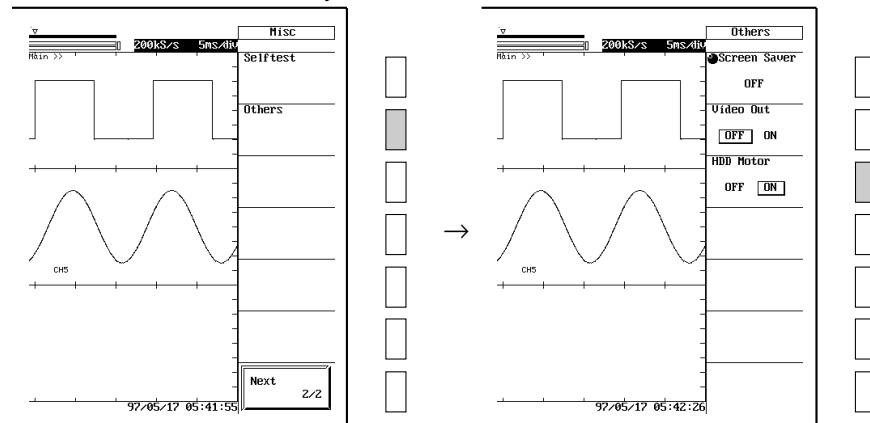

11.3 Connecting a SCSI Device

SCSI Specifications (Optional)

| Item | Specification |
|---------------------------|--|
| Interface standard | SCSI (Small Computer System Interface) ANSI X3.131-1986 |
| Connector | Half-pitch 50-pin (pin type) |
| Connector pin assignments | Single end, refer to the following table for the pin configuration Contains a terminator. |

| Pin No. | Pin Signal | Pin No. | Pin Signal |
|----------|------------|---------|------------|
| 1 to 12 | GND | 38 | TERMPWR |
| 13 | NC | 39, 40 | GND |
| 14 to 25 | GND | 41 | -ATN |
| 26 | -DB0 | 42 | GND |
| 27 | -DB1 | 43 | -BSY |
| 28 | -DB2 | 44 | -ACK |
| 29 | -DB3 | 45 | -RST |
| 30 | -DB4 | 46 | -MSG |
| 31 | -DB5 | 47 | -SEL |
| 32 | -DB6 | 48 | -C/D |
| 33 | -DB7 | 49 | -REQ |
| 34 | -DBP | 50 | -I/O |
| 35 to 7 | GND | | |

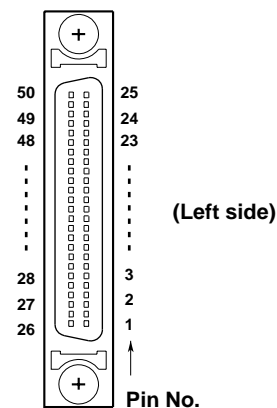

Cable and Terminator

Cable

Use a commercially sold cable that is 3 m or less in length with a ferrite core on each end and a characteristic impedance of 90 to 132Ω.

Connection Procedure

1. Connect the SCSI cable to the SCSI connector on the instrument rear panel.
2. Set the external device's SCSI ID to match the setting made at the instrument.
(For more information, see Section 11.12 below.)
3. Supply power to the instrument and to the SCSI device.
To format, follow the operating procedure in the next section, "Formatting Disks."

Support for SCSI devices

The instrument supports most but not all SCSI devices. For example, a hard disk with a capacity of up to 2 GB can be used. If you need to know whether you can use a particular SCSI model, please consult your dealer or any of the Yokogawa affiliates listed at the back of this manual.

For general information on the operation of the SCSI device, follow the operation manual that came with the device.

Note

- If you are chaining multiple SCSI devices, please place the terminator on the device that is farthest from the instrument.
- Hard disks formatted by the instrument cannot be read by NEC PC series computers.
If the internal hard disk is formatted with the PC, the realtime record function can no longer be used (if the hard disk is reformatted with the instrument, the realtime record function can again be used).

11.4 Formatting Disks

CAUTION

- Do not remove the disk or turn OFF the power while formatting is in progress ("Format..."). The media may be damaged.
- If the DL708E cannot access the formatted media, reformat the media on the DL708E. Since all data will be lost when you format the media, back up the data beforehand.

Function

Format for floppy disks

Before using a new floppy disk, you must format the disk.

Format type

Select the format type from the following, according to the type of floppy disk to be used.

2DD, 640 KB

2DD, 720 KB

2HD, 1.2 MB

2HD, 1.44 MB

Formatting the disk

The format of the media connected through the SCSI interface (optional) are as follows:

MO/PD : Semi-IBM format. Will be handled as a removable disk.

ZIP/JAZ : Hard disk format. Will be handled as a hard disk.

Hard-disk format

The format is IBM compatible.

Selecting the formatting mode

When formatting an external SCSI device, you can select from the following 2 modes.

Normal : Do a physical format and a logical format.

Quick : Do only a logical format.

The difference in the formatting time is as follows.

| Media | Normal | Quick |
|---------------------|---------------|---------------|
| MO (128 MB) | approx.10 min | approx.15 sec |
| MO (230 MB) | approx.10 min | approx.15 sec |
| External HDD (1 GB) | approx.20 min | approx.14 sec |
| Internal HDD | approx.12 min | – |

Directories available after formatting

After formatting, the following directories are created automatically.

DL_WAVE : Waveform data (*.WVF, *.HDR)

DL_SETUP : Set-up data (*.SET)

DL_MISC : Automatically waveform-parameter measurements (*.CSV)

ASCII data (*.ASD)

Binary (floating-point) data (*.FLD)

Screen image data (*.HGL, *.PS, *.TJT, *.TIF, *.BMP)

Root directory: Data for AG series (*.INF, *.WDT)

Realtime record file (REALSTRG.*, internal hard disk only)

Disk type, total disk capacity, capacity used and free capacity are also displayed.

Precautions to be taken during formatting

- If a floppy disk that contains data is formatted, all the data on the disk will be lost.
- When a floppy disk is inserted into the drive, the “Access..” message will flash, indicating that processing is in progress. Never remove the floppy disk while this message is flashing.
- The “Format..” message will appear during formatting. Never remove the disk while this message is flashing.
- Formatting for a floppy disk takes approx. one-and-half minutes.
- Before starting formatting, make sure that the write protection tab on the floppy disk is released.
- Do not execute format when this instrument is connected to the PC with the SCSI cable.

Note

- Disks formatted to MS-DOS on a PC can also be used.
- The three directories are automatically created when “Set Media” is executed.
- Logical (Quick) format only clears (initializes) the directory entries and the FAT. If you wish to check for bad sectors, do a physical (Normal) format also.
- Writing data to an external SCSI device having bad sectors may cause access error (604 Media failure). If this happens no more data can be written to the device.
As a guideline, do a Normal format on disks used for the first time or disks which can no longer be read or written, and a Quick format on disks which have been used previously.

Operating Procedure**Select the medium**

1. Press the **FILE** key.
2. Press the “**Function**” soft key as necessary to select “**Media.**”
3. Press the “**Media**” soft key as necessary to select “**FD**”, “**SCSI**”, or “**HD.**”
4. Press the “**Set Media**” soft key to register the new selection.

Displaying the format menu

5. Keep pressing the “**Function**” soft key until “**Format**” is selected.

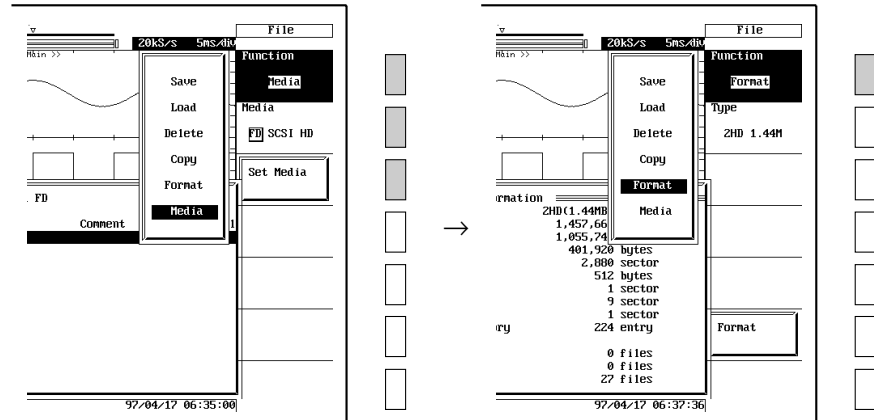

Selecting the formatting mode (only for external SCSI device)

6. Press the “Mode” soft key to select “Normal” or “Quick.”

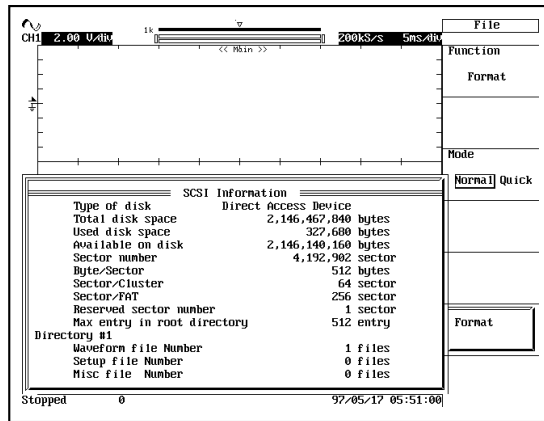

Selecting the format type (only for floppy disks)

6. Keep pressing the “Type” soft key until the desired format type is selected from “2DD 640K” to “2HD 1.44M.”

Format the disk

7. Press the “Format” soft key to display the format confirmation menu.
8. Select “OK” or “Cancel” with jog shuttle and press the **SELECT** key to confirm. If you select “OK,” format begins.

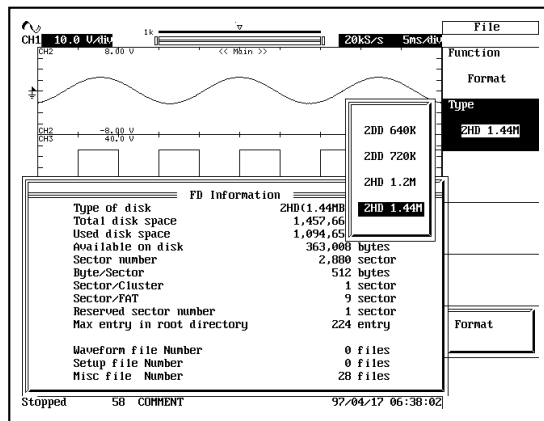

11.5 Selecting the Medium and Directory

Function

Selecting the media

You can save waveform and setting data to three storage locations:

Floppy disk (FD)

Internal hard disk (HD)

External SCSI device (SCSI)

* Internal hard disk and SCSI interface are options.

* When selecting the external SCSI device, have the “External ID” set to the ID number of the appropriate device. For details, refer to Section 11.12 “Changing the SCSI IDs.”

Directory creation

The instrument automatically creates the following three directories for data saves: DL_WAVE, DL_SETUP, and DL_MISC. On HD and SCSI devices, these directories are created within a single higher directory (a “high level” directory). When a directory is created, a directory with name DIR1 to DIRn (n is the maximum number of directories that can be created on the current media) is automatically created.

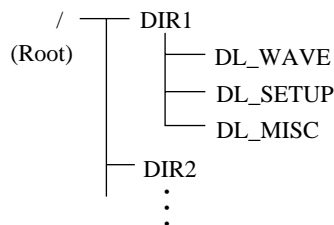

Selecting the directory for saving or loading

Since the MO disk or external SCSI device can make multiple high-level directories, you must select the appropriate target directory when saving or loading data.

You select the directory by its number. Directory numbers run from 1 up to the maximum number of directories supported by medium.

Operating Procedure

Selecting the medium

1. Press the **FILE** key.
2. Press the “**Function**” soft key until “**Media**” is selected.
3. Press the “**Media**” soft key as necessary to select “**FD**”, “**SCSI**”, or “**MO**.”
4. Press the “**Set Media**” soft key to register the new selection.

Creating directories (to HD or SCSI only)

5. Pressing the “**Add Dir**” soft key creates one directory.

Selecting the target directory

5. Press the “**Change Dir to**” soft key to set the jog shuttle action to “**Change Dir to**.”
6. Turn the jog shuttle to select the directory number.
7. Press the “**Change Dir**” soft key to change to the selected directory.

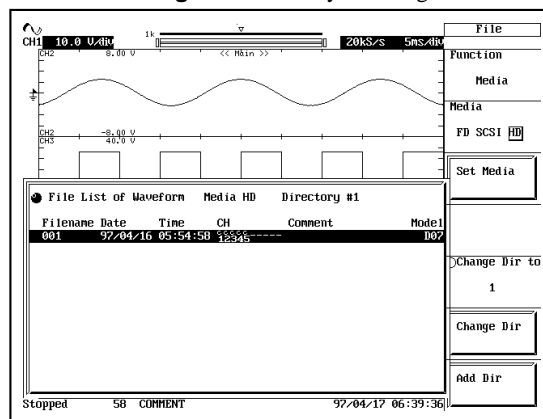

11.6 Saving/Loading Waveform Data

CAUTION

- Never remove the disk or turn OFF the power while the drive is processing the insertion of the disk or while saving (“Access...”). The media may be damaged.

Function

Savable data

- The currently displayed waveform on CH1 to CH8, Math1 and Math2. However, accumulated waveforms cannot be saved.
- You can save waveform data displayed from history memory, using the history memory function.
 - If Display=One : Save waveform data for selected record (Selected Record No.) only.
 - If Display=All : Save waveform data for all records from Start Record No. to End Record No.
- The current vertical axis, horizontal axis and trigger settings

Required memory capacity (in bytes)

CH1 to CH8 waveform data : Record length x Number of channels which are ON x
Number of records* x 2 bytes

Computed waveform data : Number of data corresponding to one waveform x 2 bytes

The current vertical axis, horizontal axis and trigger settings : 8K bytes

axis and trigger settings

* Number of records : One when the acquisition mode is averaging mode
Number of the waveform data selected with “Display” of the History menu when the acquisition mode is other than the averaging mode

Waveforms which can be saved

All waveforms which are currently displayed can be saved. Therefore, all waveforms currently displayed can be saved while accumulation of multiple records is performed in the sequential memory or history memory. However, no snap shot or histogram waveform can be saved. In addition, waveforms on the channels which are used when computation is ON are also saved, irrespective of whether their displays are ON or OFF.

Auto Naming

If “Auto Naming” is on when the waveform data are being saved to the medium, a file number (from “000” to “999”) is automatically assigned. It is possible to insert a common file name (character string consisting of up to five characters) before the assigned file number. The common file name is set in the file name menu.

File name and comment

A file name must be provided, but it is not necessary to provide a comment. For details refer to page 4-2.

Select the data range to save

Select from the following. To save the realtime recorded waveform data, see the next page “Saving/Loading the realtime recorded waveform data.”

All : Save the entire record length of data.

Main : Save the display record length (the range displayed on the screen) of data.

Z1 : Save the portion displayed in the Z1 zoom waveform display frame.

Z2 : Save the portion displayed in the Z2 zoom waveform display frame.

Data that are saved using “Z1” or “Z2” may display an incomplete waveform when it is loaded. This is because data can be saved in any length, but loading can be done only in fixed amounts of the record length.

Precautions to be taken when storing waveform data

- Storing is not possible while acquisition is in progress. To enable storing, press the **START/STOP** key to stop acquisition.
- Key operations, except for file key operations, can be performed even if processing or storing is in progress.
- Storing is performed for all channels. It is not possible to select channels (by turning the display ON or OFF).
- Waveform data are stored automatically into the DL_WAVE directory, with an extension identifier “WVF” added. Header files (*.HDR), which are used for analysis of waveforms with a personal computer, are also created in the DL_WAVE directory. However, these header files cannot be looked at using this instrument. For a description of a header file, refer to Appendix 4.
- The maximum number of files that can be saved in a single directory is 1000.

Content of data load

- Previously saved waveform data. (But computational waveform data cannot be reloaded. Refer to Appendix 4.)

Comparing waveforms against a loaded waveform

When waveform data are loaded from a file, all waveform data in the memory up to that point are cleared and only the loaded waveform is displayed on the screen. By retaining this waveform on the screen using the snap shot function and acquiring new data, you can compare the two waveforms.

- * If the loaded waveform data of a file contain one waveform, the data are placed in the “0” position of the history memory.
If the loaded waveform data contain multiple waveforms (if multiple waveforms were acquired using the accumulate/sequential store/history memory functions), all the waveforms are placed in the history memory in order.
The newest waveform of the loaded data is placed in the “0” position, the next newest in the “-1” position, the third newest in the “-2” position, and so on.

Precautions to be taken when loading waveform data

- Vertical-axis, horizontal-axis, and trigger settings in effect at the time of the save.
- Loading is not possible while acquisition is in progress. To enable recalling, press the **START/STOP** key to stop acquisition. When acquisition is restarted, the loaded waveform will be deleted (but will still remain in the history memory).
- Cursor measurement, automatic measurement of waveform parameter, computation and expansion/reduction operations can be performed on the loaded waveform.
- The waveform data resides in the DL_WAVE directory, with the extension identifier “WVF.” For the file extension of the realtime recorded waveform data, see “Saving/Loading the realtime recorded waveform data” below.
- The waveform data are composed of two files, a file with an extension .WVF (or .RTM) and a file with an extension .HDR. Do not delete or rename these files such as on a PC. If you do so, you will not be able to load the data.

Saving/Loading the realtime recorded waveform data

- If “the data range to save” on the previous page is set to “All”
All of the realtime recorded waveform data are saved. The file is saved with an “*.RTM” extension in the “DL_WAVE” directory. “RTM” is displayed in the Model column of the file list. If you load the “RTM” data, the data are loaded to the realtime record area (see page 1-14) not to the acquisition memory. Therefore, all data points can be loaded.
- If “the data range to save” is set to “Main,” “Z1,” or “Z2”
The specified range of waveform data is saved. The file is saved with an “*.WVF” extension in the “DL_WAVE” directory. The data that can be loaded are from the beginning to the maximum record length (see appendix 2 “Relationship between the Record Length and Acquisition Mode”). If you load the data that were saved using “Z1” or “Z2,” an incomplete waveform may be displayed because the length is less than the record length.

Confirming the module configuration/record length of the file to load

You can confirm the module configuration/record length that existed at the time the data were saved. The current module configuration is also listed. Furthermore, the channels that differ in the configuration between the current and the saved data are indicated with red characters. If the saved data are loaded in a condition in which the current module configuration is different from the module configuration that existed when the data were saved, then correct waveforms are displayed only for channels that have the same modules installed. Correct waveforms will not be displayed for channels that have different modules installed. Moreover, the data cannot be loaded for channels that do not have modules installed.

Note

The waveform data of each channel can also be stored in ASCII or floating point format. However, it is not possible to display the waveform on the screen if it is stored in these formats. For details refer to page 11-14.

Operating Procedure

Displaying the storage menu

1. Press the **FILE** key.
2. Keep pressing the **Function** soft key until **Save** is selected.

Selecting waveform data, entering a file name and comment, and starting storing

3. Press the **Mode** soft key to display the storage source menu.
4. Keep pressing the **Mode** soft key again until **Waveform** is selected.
5. Press the **File Name(Save) & Comment** soft key to display the file name setting menu.
6. Move the cursor to **Auto Naming** with the jog shuttle, and press **SELECT** key to select **ON** or **OFF**. If you select **ON**, ******** is displayed on the soft key menu. If a file name is specified, then ******** is displayed after the file name.
7. Move the cursor to **Filename** with the jog shuttle, and press **SELECT** key to display the keyboard screen.
8. Enter the file name using the procedure described on page 4-2.
9. In the same way, enter a **Comment** if necessary.

Specifying range to store and storing

10. Press the **Range** soft key several times to select from **All** to **Z2**.
11. Press the **Save** soft key to start saving.

To stop saving, press the **Abort** soft key.

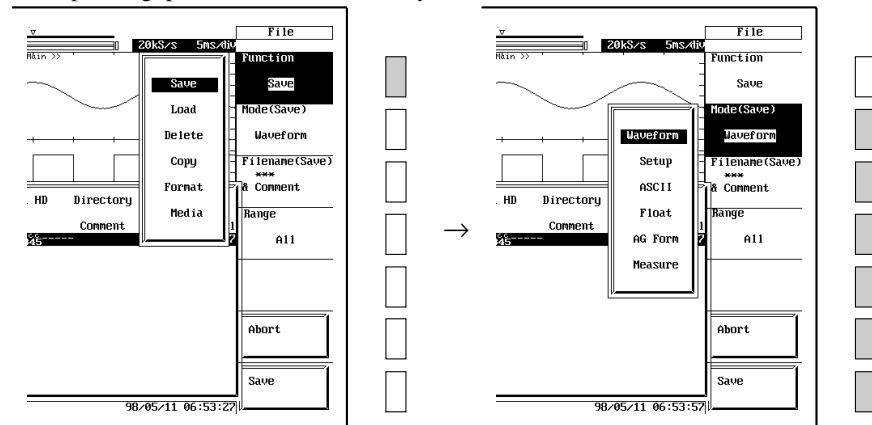

Displaying the load menu

- 1. Press the **FILE** key.
- 2. Keep pressing the **Function** soft key until **Load** is selected.

Selecting the waveform data and file to be loaded, Confirming the module configuration/record length of the file to load and starting loading

- 3. Press the **Mode** soft key to display the load source menu.
- 4. Keep pressing the **Mode** soft key until **Waveform** is selected.
- 5. Turn the jog shuttle to select the file to be loaded.

Confirming the module configuration/record length

- 6. You can confirm the module configuration and record length by pressing the **File Information** soft key.

Loading

- 7. Press the **Load** soft key to start loading.
To stop loading, press the **Abort** soft key.

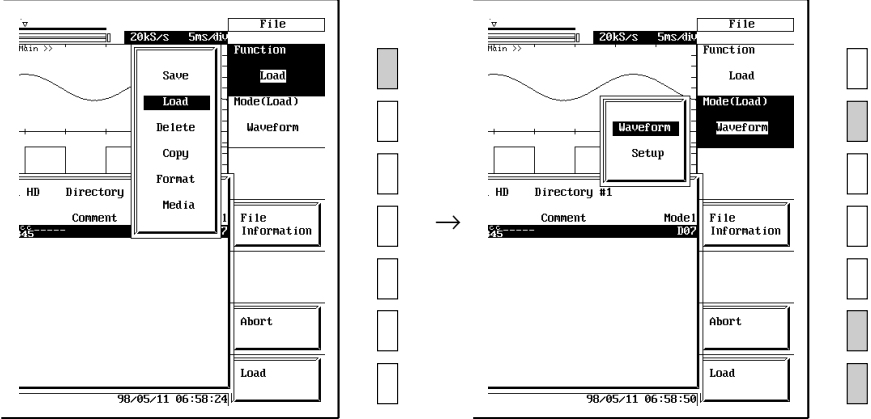

11.7 Saving/Loading Set-up Data

Function

Saving the set-up data

Except for the date/time, communication and SCSI ID number set-up data, the current set-up data, set with the panel keys, can be stored.

Required memory capacity (in bytes)

Approx. 8 K bytes

File name and comment

A file name must be provided, but it is not necessary to provide a comment. For details refer to page 4-2.

Auto naming function

When “Auto Naming” is set to ON, files are automatically created with 3-digit numbers from “000” to “999.” A common filename (up to 5 characters, specified with Filename) can be inserted before the number.

Precautions to be taken when storing set-up data

- Storing is not possible while acquisition is in progress. To enable storing, press the **START/STOP** key to stop acquisition.
- The set-up data will be stored automatically into the DL_SETUP directory, with the extension identifier “SET.”
- The maximum number of files that can be saved in a single directory is 1000.

Loading the set-up data

When set-up data is loaded, the current key settings are replaced by the loaded set-up data, except for the date/time and the GP-IB settings. However, date, time, GP-IB settings, settings dealing with File, and SCSI ID number are not changed.

Precautions to be taken when loading set-up data

- Loading is not possible while acquisition is in progress. To enable loading, press the **START/STOP** key to stop acquisition.
- Set-up data resides in the DL_SETUP directory and has the extension identifier “SET.”
- Do not delete or rename the file such as on a PC. If you do so, you will not be able to load the data.

Confirming the module configuration/record length of the file to load

You can confirm the module configuration/record length that existed at the time the data were saved. The current module configuration is also listed. Furthermore, the channels that differ in the configuration between the current and the saved data are indicated with red characters. If the saved data are loaded in a condition in which the current module configuration is different from the module configuration that existed when the data were saved, then only the channels that have the same modules installed will be set up correctly. Channels that have different modules installed may not be set up correctly. The data cannot be loaded for channels that do not have modules installed.

Note

For versions 4.00 and later, the balance data for the strain module can be saved.

- The data are saved along with the set-up data.
 - When the set-up data are loaded, the balance data are overwritten.
 - If balancing has not been executed, the balance data are not saved.
-

Operating Procedure

Displaying the storage menu

1. Press the **FILE** key.
2. Keep pressing the “**Function**” soft key until “**Save**” is selected.

Selecting set-up data, entering a file name and comment, and starting storing

3. Press the “**Mode**” soft key to display the storage source menu.
4. Keep pressing the “**Mode**” soft key until “**Setup**” is selected.
5. Press the “**File Name(Save) & Comment**” soft key to display the file name setting menu.
6. Move the cursor to “**Auto Naming**” with the jog shuttle, and press **SELECT** key to select “**ON**” or “**OFF**.” If you select “**ON**,” “***” is displayed on the soft key menu. If a file name is specified, then “***” is displayed after the file name.
7. Move the cursor to “**Filename**” with the jog shuttle, and press **SELECT** key to display the keyboard screen.
8. Enter the file name using the procedure described on page 4-2.
9. In the same way, enter a “**Comment**” if necessary.
10. Press the “**Save**” soft key to start storage.

To stop storage, press the “**Abort**” soft key.

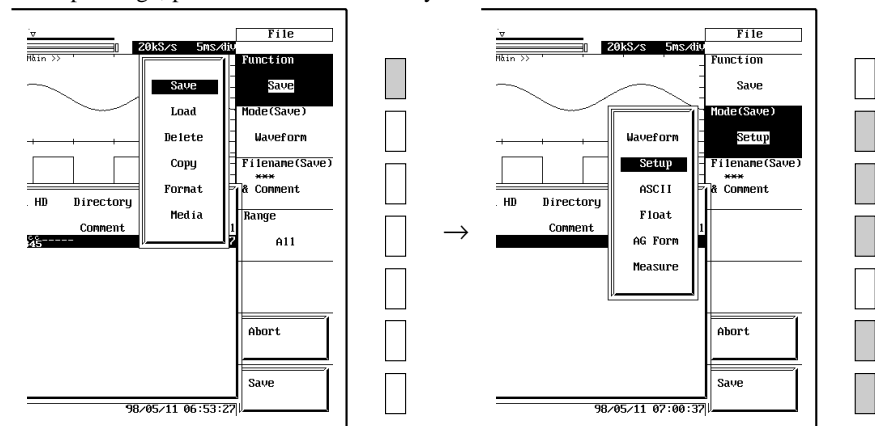

Displaying the load menu

1. Press the **FILE** key.
2. Keep pressing the “**Function**” soft key until “**Load**” is selected.

Selecting the set-up data and file to be loaded, Confirming the module configuration/record length of the file to load and starting loading

3. Press the “**Mode**” soft key to display the load source menu.
4. Keep pressing the “**Mode**” soft key until “**Setup**” is selected.
5. Turn the jog shuttle to select the file to be loaded.

Confirming the module configuration/record length

6. You can confirm the module configuration and record length by pressing the “**File Information**” soft key.

Loading

7. Press the “**Load**” soft key to start loading.
- To stop loading, press the “**Abort**” soft key.

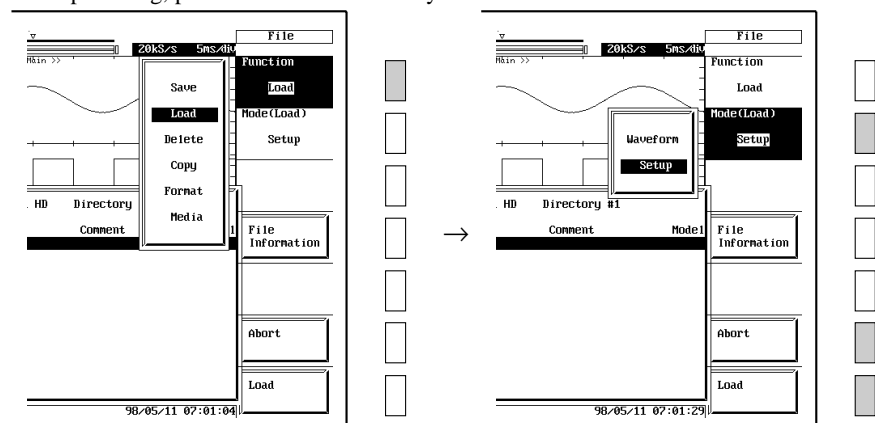

11.8 Saving Waveform Data in ASCII, Binary or AG Series Format

Function

ASCII format

Waveform data is stored in ASCII format. This is useful when you want to analyze the waveform data using a personal computer.

Binary format (Float)

Waveform data is stored in 32-bit floating-point format. This is also useful when you want to analyze the waveform data using a personal computer.

AG format

Waveform data is stored in the format used by YOKOGAWA's AG series Arbitrary Waveform Generator. Waveform data acquired by the instrument can be down-loaded to an AG series unit.

Directories, extension identifiers, capacity required

Refer to the table below. For files used by the AG series, refer to the User's Manual provided with the AG series unit.

| Data format | Directory | Identifier | Number of Bytes |
|----------------------|----------------|--------------|---|
| ASCII | DL_MISC | *.ASD | About (13 × record length × number of traces)*1 |
| BINARY (Float-point) | DL_MISC | *.FLD | About (4 × record length)*1 |
| AG Format | Root directory | *.INF,* .WDT | About (5 × record length) |

*1 If you saved multiple records using "Start/End Record No." of the history memory function, multiply the result by the (number of records).

Waveforms which can be stored

A waveform from only one of the following channels can be stored.

CH1 to CH8, Math1, Math2, All (Traces which have their display turned ON, available only for ASCII format)

Moreover, no snap shot, accumulated waveform or histogram waveform can be stored. If multiple records are displayed using the history memory, only the waveform identified by "Selected Record No." is stored.

However, for ASCII format and BINARY format, you can choose how to save the waveform data from the following.

Display=One : Waveform data selected with the Selected Record No.

Display=All : Waveform data specified from the Start Record No. to the End Record No.

File name and comment

A file name must be provided, but it is not necessary to provide a comment. For details refer to page 4-2.

Select the data range to save

• For ASCII format and Binary format

Select from the following.

All : Save the entire record length of data.

Main : Save the display record length (the range displayed on the screen) of data.

Z1 : Save the portion displayed in the Z1 zoom waveform display frame.

Z2 : Save the portion displayed in the Z2 zoom waveform display frame.

• For AG format

You can select any position to start storing.

The number of points stored is 1 K, 2 K, 4 K, or 8 K points from the start point.

Precautions to be taken when saving waveform data

- Storing is not possible while acquisition is in progress. To enable saving, press the **START/STOP** key to stop acquisition.
- The saved waveform cannot be recalled by the instrument.
- Storing all channels at once is possible only in the ASCII format.
- The maximum number of files that can be saved in a single directory is 100 for each data format.

Operating Procedure

Displaying the storage menu

1. Press the **FILE** key.
2. Keep pressing the **Function** soft key until **Save** is selected.

Selecting the data format

3. Press the **Mode** soft key to display the saving source menu.
4. Keep pressing the **Mode** soft key to select either **ASCII**, **Float** or **AG Form.**

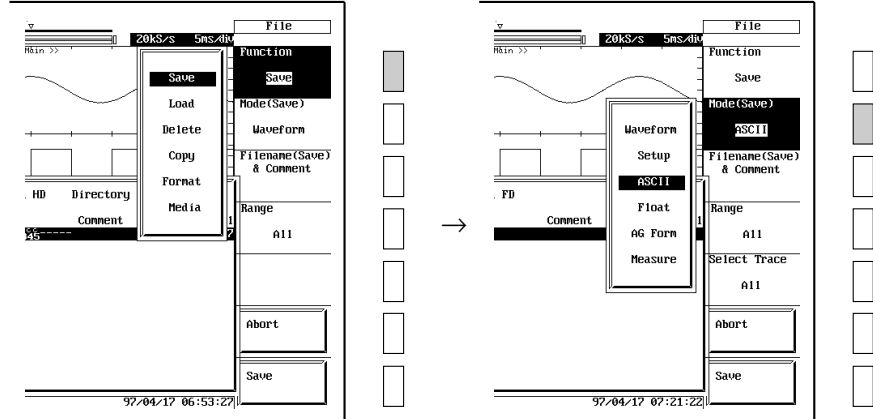

Selecting the waveform to be saved, entering a file name and comment

5. Press the **Select Trace** soft key to display the saving source menu.
6. Keep pressing the **Select Trace** soft key to select the desired waveform source from **CH1** to **Math2.** Channels which do not have input modules installed are not displayed on the menu.
7. Press the **File Name(Save) & Comment** soft key to display the file name setting menu.
8. Move the cursor to **Auto Naming** with the jog shuttle, and press **SELECT** key to select **ON** or **OFF.** If you select **ON,** ******** is displayed on the soft key menu. If a file name is specified, then ******** is displayed after the file name.
9. Move the cursor to **Filename** with the jog shuttle, and press **SELECT** key to display the keyboard screen.
10. Enter the file name using the procedure described on page 4-2.
11. In the same way, enter a **Comment** if necessary.

Setting the data save range (When using **ASCII** or **Binary**)

12. Press the **Range** soft key several times to select from **All** to **Z2.**

Setting the data save range (When using **AG Form**)

12. Press the **AG Form Length** soft key (**Next 2/2** menu) as necessary to select the range (1K, ..., 8K).
13. Press the **AG Form Start** soft key.
14. Turn the jog shuttle to select the start position for the save. (You can use the arrow keys to move to different columns within the value.)

Starting saving

15. Press the **Save** soft key to start saving.
- To stop saving, press the **Abort** soft key.

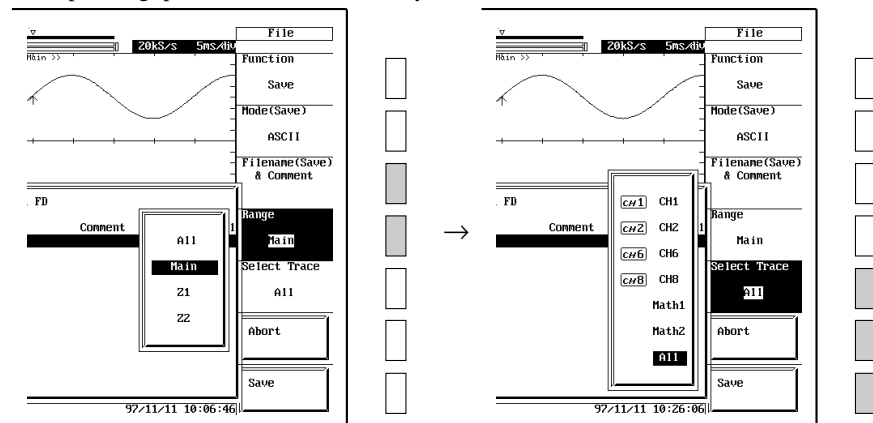

Note

For information about saves in "Measure" format, see page 11-18.

11.9 Deleting Files

Function

A file saved on a floppy disk, a MO disk, or an external SCSI device can be deleted.

Deletion disabled/enabled

Deletion can be disabled or enabled for each file. A "*" will be displayed by files for which deletion is disabled.

Selecting files for deletion

You can mark selected files for deletion, then delete them all at once. The letter "D" appears at the left of the filename to indicate that the file is marked for deletion. There are two ways to mark (or unmark) files.

- Use the jog shuttle to choose a file, and then press the **SELECT** key to mark it (or unmark it).
- Use the **"Mark/Unmark All Files"** soft key to mark or unmark all files at once.
Note that if you execute deletion when no file is marked, the instrument deletes the file selected at the File List menu.

Operating Procedure

Displaying the delete menu

1. Press the **FILE** key.
2. Keep pressing the **"Function"** soft key until **"Delete"** is selected.

Selecting the data format

3. Keep pressing the **"Mode"** soft key to select the desired format from **"Waveform"** to **"Image."**

Selecting the file to be deleted

4. Turn the jog shuttle to select the file to be deleted and press **SELECT** key.

To mark all files for deletion

4. Press the **"Mark/Unmark All Files"** soft key once to mark all files for deletion (D mark), or again to unmark all files. If you want to remove most but not all files, you may find it convenient to mark all of them for deletion and then use the jog shuttle and the **SELECT** key to unmark the files you want to keep.

Execute the deletion

5. Press the **"Delete"** soft key. The screen returns a confirmation prompt. Highlight the OK response, and press the **SELECT** key to delete all marked files.

Turning deletion ON/OFF

6. Pressing the **"Protect ON"** soft key disables deletion of a file.
7. Pressing the **"Protect OFF"** soft key enables deletion.

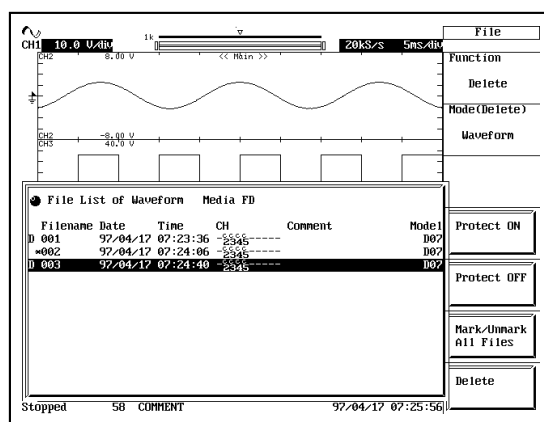

Note

Deletion is not possible when waveform acquisition is active. Press the **START/STOP** key to stop acquisition.

11.10 Copying Files

Function

This function lets you copy your saved files from one location (floppy, Internal hard disk, or SCSI device) to another.

Precautions to be taken when copying a file

- Copying is not possible while acquisition is in progress. To enable copying, press the **START/STOP** key to stop acquisition.
- Copying a file to a file with a different identifier is not possible.
- If the copy destination is an Internal hard disk or SCSI device, you must also specify the destination directory.

Operating Procedure

Selecting the media with copy source file and displaying the copy menu

1. Press the **FILE** key.
2. Keep pressing the “**Function**” soft key until “**Media**” is selected.
3. Keep pressing the “**Media**” soft key to select the media with copy source file, and press the “**Set Media**” soft key.
4. Keep pressing the “**Function**” soft key until “**Copy**” is selected.

Selecting the data format

5. Keep pressing the “**Mode**” soft key to select the desired format from “**Waveform**” to “**Image**.”

Entering the copy source and destination file names and comment

6. Turn the jog shuttle to select the file to be copied.
7. Press the “**File Name**” soft key to display the keyboard screen.
8. Enter the desired file name for the copy destination file using the procedure described on page 4-2.
9. Enter a comment as well if you like.

Select the copy destination

10. Press the “**Destination**” soft key as necessary to select the destination (FD, SCSI, or HD).
11. If you have selected “**SCSI**” or “**HD**,” turn the jog shuttle to select the destination directory.
For details about directories, refer to Section 11.5, “Selecting the Medium and Directory.”

Starting copying

12. Press the “**Save**” soft key to start copying.
To stop copying, press the “**Abort**” soft key.

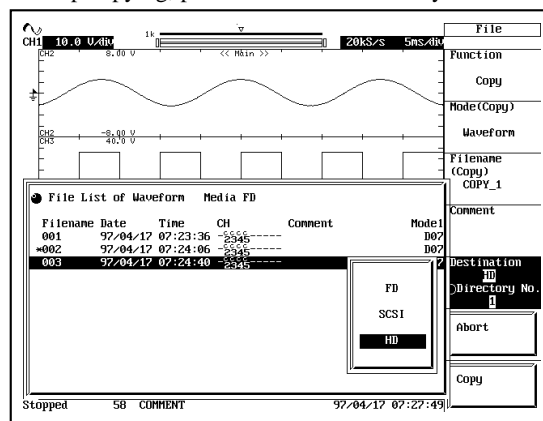

Note

If you select a directory number for a nonexistent directory as your destination, an error will occur when the copy is executed. (Note that floppy disks do not have high level directories.)

11.11 Saving Automatic Measurement Results

Function

The instrument lets you save results of automatic measurements to floppy disk, Internal hard disk, or SCSI device. The save file is assigned the “.CSV” file extension. The file contains measurement results of the waveform parameters selected for automatic measurement. These CSV files are in comma-delimited text format. This format is widely used for transferring data among commercial database and spreadsheet applications.

Auto naming function

When “Auto Naming” is set to ON, files are automatically created with 3-digit numbers from “000” to “999.” A common filename (up to 5 characters, specified with Filename) can be inserted before the number.

Restrictions

The following restrictions apply to measurement saves.

- A maximum of 8 parameters can be saved.
- The save can include results from as many as 512 measurement cycles (starting from the most recent cycle and working back), provided that the Time/div, Volt/div, and “Measure” settings have remain fixed. You cannot save any results obtained before the most recent change in any of these settings.

Sample output

```

" DL708"
" CH1 Max," " CH1 Min," " CH1 Rms," " CH2 Rise"
0.500E+00, 0.000E+00, 0.199E+00, 0.02E-06           Old data
0.375E+00, 0.000E+00, 0.207E+00, 0.02E-06
0.313E+00,-0.125E+00, 0.152E+00, 0.02E-06
•           •           •           •           ↓
•           •           •           •
•           •           •           •
•           •           •           •           New data
    
```

Operating Procedure

1. Press the **FILE** key.
2. Press the “**Function**” soft key as necessary to select “**Save.**”
3. Press the “**Mode(Save)**” soft key to select “**Measure.**”
4. Press the “**File Name(Save) & Comment**” soft key to display the file name setting menu.
5. Move the cursor to “**Auto Naming**” with the jog shuttle, and press **SELECT** key to select “**ON**” or “**OFF.**” If you select “**ON,**” “***” is displayed on the soft key menu. If a file name is specified, then “***” is displayed after the file name.
6. Move the cursor to “**Filename**” with the jog shuttle, and press **SELECT** key to display the keyboard screen.
7. Enter the file name using the procedure described on page 4-2.
8. In the same way, enter a “**Comment**” if necessary.
9. Press the “**Save**” soft key to save the parameter measurements to disk.

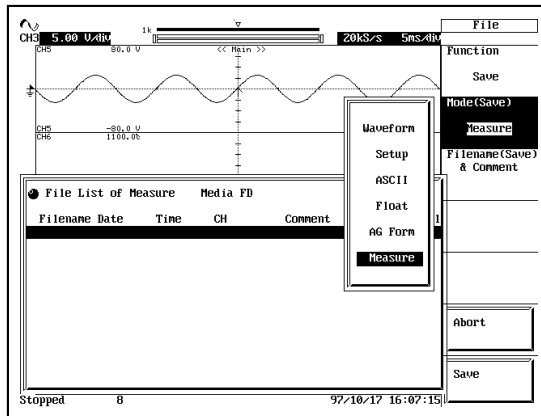

11.12 Changing the SCSI IDs

Function

SCSI IDs identify the devices connected to the SCSI bus. Each device on the bus must have a unique ID. Default IDs are as follows.

SCSI ID (Own) : 6

SCSI ID (External : external SCSI device) : 5

SCSI ID (Internal : internal hard disk) : 4

* Internal hard disk and SCSI interface are options.

Range for SCSI ID numbers

0 to 7

Terminator ON/OFF

The terminator can be turned ON/OFF according to the system being used. The default setting is "ON."

Precautions and Notes

- The same numbers cannot be set to SCSI ID (Own), SCSI (External) and SCSI (Internal).
- Do not set the SCSI ID number of the instrument (initial value 6) to the internal hard disk or the external SCSI device.
- The SCSI device corresponding to the ID number of "External ID" is the device which various data is saved to and read from. Set the ID number of the device you wish to save or read the various data.
- When changing the SCSI ID numbers of the instrument and the internal hard disk, make sure to press the "Initialize SCSI" soft key.
- If you change the ID for an external device at the instrument side, remember that you make the same change at the external device's side. For instruction on how to make the change at the external side, refer to the documentation provided with your external device.

Operating Procedure

Changing SCSI ID for the instrument or for the Internal hard disk

1. Press the **MISC** key.
2. Press the "SCSI" soft key.
3. Press the "Own ID" or "Internal ID" soft key to select the jog shuttle action.
4. Turn the jog shuttle to set the ID.
5. Press the "Initialize SCSI" soft key to execute the change of the ID number.

Select the SCSI device to access

3. Press the "External ID" soft key so that the jog shuttle controls the "External ID."
4. Turn the jog shuttle to set the ID number of the SCSI device to save/load the various data.

Turn ON/OFF the terminator

Press the "Terminator" soft key and select "ON" or "OFF."

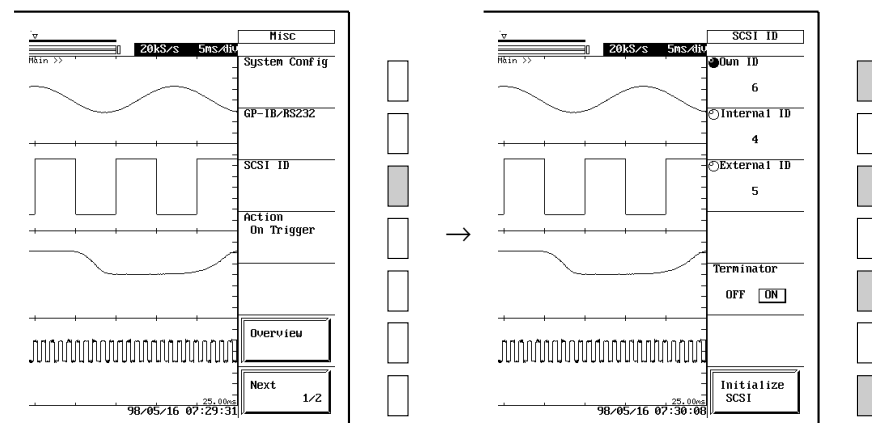

Note

When changing the "External ID," the "Initialize SCSI" soft key does not need to be pressed.

11.13 Connecting to a PC

You can connect a PC to the instrument via the SCSI. Once the connection is established, you can use the PC to access the internal hard disk.

Items Required to Connect

- SCSI cable (half-pitch 50-pin, pin type)
Use a commercially sold SCSI cable that is 3 m or less in length with a ferrite core on each end and a characteristic impedance of 90 to 132 Ω .

Connection procedures

Changing the SCSI ID of the instrument

Before connecting the instrument to a PC, you may need to change the instrument's SCSI ID so that it does not conflict with the PC's ID.

1. Press the **MISC** key.
2. Press the "**SCSI ID**" soft key.
3. Press the "**Own ID**" soft key so that the jog shuttle action is set to Own ID.
Then turn the jog shuttle to select the new ID for the instrument.
4. Press the "**Initialize SCSI**" soft key to register the new ID.

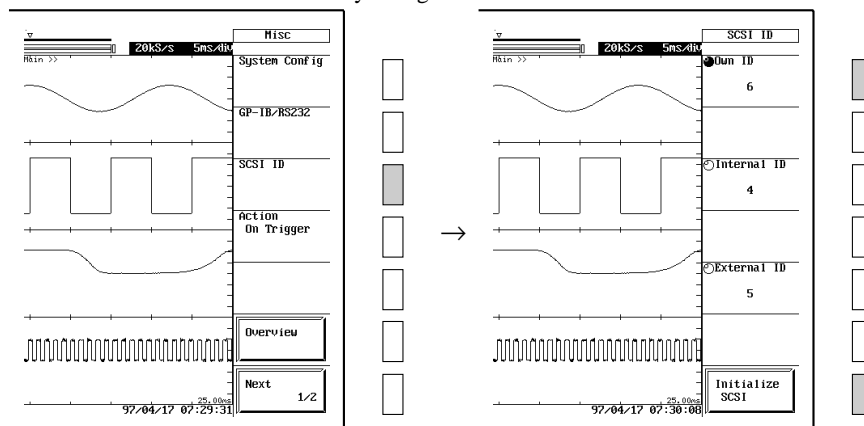

Changing the SCSI ID of the internal hard disk

Set the ID number of the internal hard disk drive so that it does not overlap with the ID's of other SCSI devices. For information on setting the ID, refer to Section 11.12 "Changing the SCSI IDs."



CAUTION

Make sure to follow the procedures exactly as written in “Connecting the instrument to the PC” described below. If these procedures are not followed, it may damage the media in other SCSI devices connected to the PC.

Connecting the instrument to the PC

1. Switch off the power to the instrument and the PC.
2. Connect the instrument to the PC with the SCSI cable.
3. Turn ON the power switch of the instrument, first.
4. Check that the SCSI device being connected operates on this instrument. (Press the “**Function**” soft key in the File menu and select “**Media.**” Then, check that the specified device can be selected with “**Set Media.**”)
5. Turn ON the PC.

When connecting to a PC with Windows95 OS

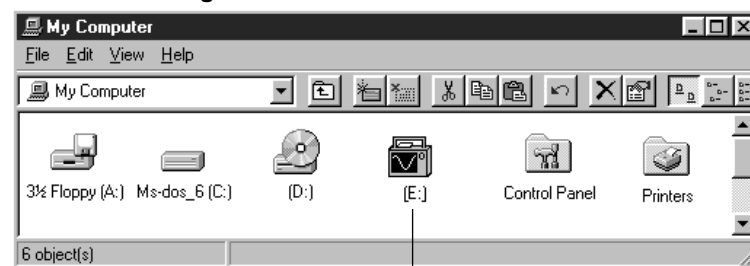

DL708E

Precautions when connecting

Files that should not be deleted

The following files are created at the root directory when the internal hard disk is formatted with the instrument. Do not delete any of these files.

If you delete any of these files, you will no longer be able to realtime record to the internal hard disk. If it is deleted, reformat the internal hard disk with the instrument.

/AUTORUN.INF
 /DL708.ICO
 /DRIVE.INF
 /REALSTRG.*

Newly created files during connection

If a file is created with the instrument while it is connected to the PC, there are cases when the file is not recognized by the PC.

In these cases, reconnect the instrument and the PC by following the procedures given in “Connecting the instrument to the PC.”

However, if the PC is running Windows95, the following procedures allow the files to be recognized.

1. On Windows95, Open the property settings of the drive that is connected and check the Removal box*.
 2. Restart the PC.
 3. After creating a new file with the instrument, select “**View→Refresh**” with the Explore on the PC.
- * Select the drive from the drive list from the menu (**My Computer→Control Panel→System→Device Manager→Disk drives**). If you open the “**Properties**,” the “**Removable**” check box is displayed. You can check the drive number with “**Current Drive.**”

File list

You can view the file list (Filelist.vol) of the internal hard disk and floppy disk of this instrument, and SCSI device connected to this instrument, on a PC. Do not delete or alter the data in this file. If you do so, the instrument will not be able to recognize the data. If you happen to delete or alter the file list data, follow the procedures below to create a correct file list.

1. Delete the file list (Filelist.vol) on the PC.
2. Perform steps 1 to 4 in section “11.5 Selecting the Medium and Directory” on the instrument.

Drive letter

If there are two or more hard disks on the PC that is being connected to the instrument, or if the hard disk is partitioned, the drive letters of the extra drives (D:, E:, etc.) connected to the PC may change when the instrument is connected. For details, refer to the instruction manual of the PC or the drive.

Note that the drive letter of the instrument can not be changed.

Example

- When using the PC's internal hard disk as one drive
Before connection C: (HDD)
After connection C: (HDD)
D: (this instrument)
- When using the PC's internal hard disk as two drives
Before connection C: (HDD)
D: (HDD)
After connection C: (HDD)
D: (this instrument)
E: (HDD)

Actually, this varies depending on how the hard disk is partitioned or on the different types of interface types (IDE, SCSI, etc.) or on the drive types.

Note

The instrument must connect to the end of the SCSI chain, as the internal hard disk includes a built-in terminator.

12.1 External Trigger Input (TRIG IN)



CAUTION

Never input any signals which do not meet the following specifications, otherwise damage to the instrument may result due to an excessive voltage.

EXT TRIG IN terminal



This terminal is used when an external signal is used as the trigger source. (Refer to page 6-2.)

Specifications

- Connector type : RCA jack
- Input level : CMOS
- Minimum pulse width : 1 μ s
- Logic : Rising edge, falling edge, rising/falling edge
- Trigger delay time : Within (2 μ s + 1 sample period)

Input circuit Diagram/ Timing Chart

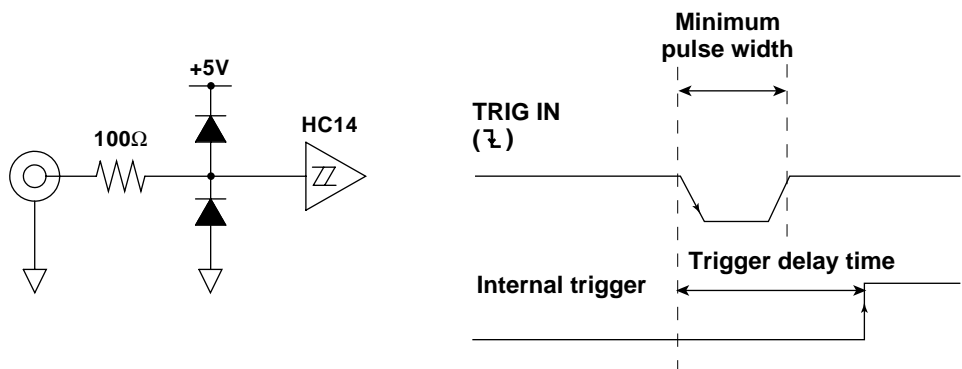

Note

By using the trigger output function, two units of DL708E can be operated synchronously.

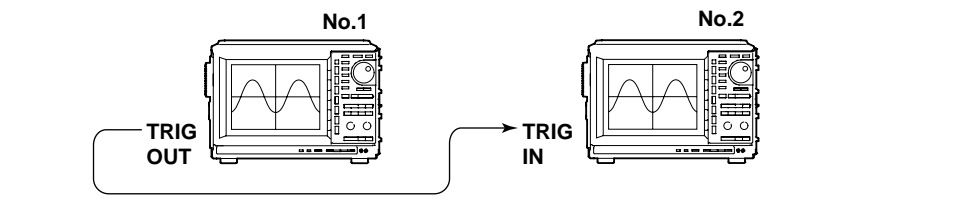

12.2 Trigger Output (TRIG OUT)



CAUTION

Never apply an external voltage to the TRIG OUT terminal, otherwise damage to the instrument may result.

TRIG OUT Terminal



A CMOS signal is output when a trigger is caused. The level is normally high, but goes low when a trigger is activated.

Specifications

| | |
|-------------------|--|
| Connector type | : RCA jack |
| Output level | : CMOS |
| Output logic | : $\overline{1}$ (negative) |
| Output delay time | : within (1 μ s + 1 sample period) |
| Output hold time | : 200 ns min. for low level |

Circuit Diagram/Timing Chart of the Trigger Output

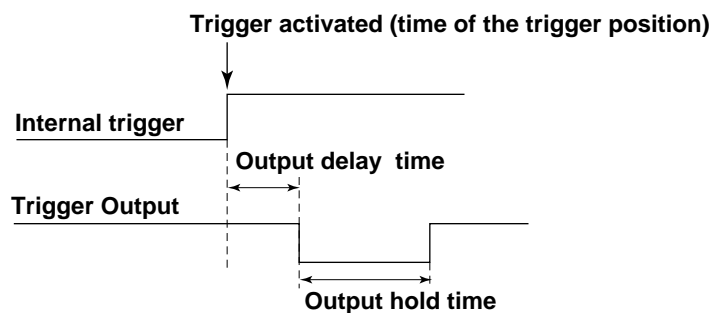
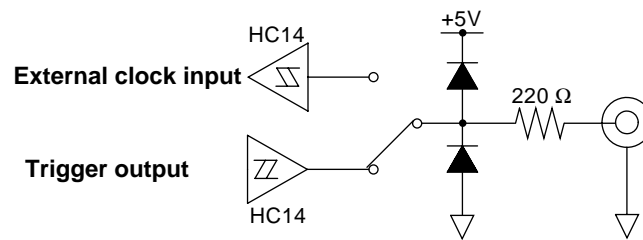

12.3 Video Signal Output (VIDEO OUT)



CAUTION

- Before connecting the monitor to the instrument, be sure to turn OFF the power to both monitor and instrument.
- Never short-circuit the RGB VIDEO OUT terminal or apply an external voltage, otherwise damage to the instrument may result.

VIDEO OUT terminal

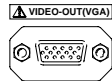

The instrument's screen can be displayed on a monitor via this terminal. Only a VGA monitor or a multi-synchronous monitor which is capable of displaying VGA can be used.

Specifications

| | Pin No. | Signal Name | Specification |
|--------------------------------|---------|-------------------------------|--|
| <p>D-Sub 15-pin receptacle</p> | 1 | 1 Red | 0.7 V _{p-p} |
| | 2 | Green | 0.7 V _{p-p} |
| | 3 | Blue | 0.7 V _{p-p} |
| | 4 | — | |
| | 5 | — | |
| | 6 | } GND | |
| | 7 | | |
| | 8 | | |
| | 9 | — | |
| | 10 | GND | |
| | 11 | — | |
| | 12 | — | |
| | 13 | Horizontal synchronous signal | Approx. 31.5 kHz, TTL negative \square |
| | 14 | Vertical synchronous signal | Approx. 60 Hz, TTL negative \square |
| | 15 | — | |

Connecting to the monitor

1. Turn OFF the power to both the monitor and the instrument.
2. Connect the monitor to the instrument using an analog RGB cable.
3. Turn ON both the monitor and the instrument.
4. Press the **MISC** key.
5. Press the “Next” soft key to display the “Next 2/2” menu, and press the “Others” soft key.
6. Pressing the “Video Out” soft key and selecting “ON” displays the instrument's screen on the monitor. Selecting “OFF” stops the display on the monitor.

Note

- To reduce the power consumption, set “Video Out” to “OFF” when not in use. The initial value of “Video Out” is “OFF.”
- The picture on the monitor may become unstable if the instrument or other equipment is brought too close to the monitor.
- Some monitors may display a picture from which the sides are missing.

13.1 Setting the Screen Color

Function

A color can be set for each of the items listed below. The color is defined by its R (red), G (green) and B (blue) settings.

Graphic items

Back : Background
 Graticule : Scale
 Cursor : Cursor
 Snap : Snap shot waveform
 CH1 to CH8 : Waveform

Text items

Menu Fore : Selected menu items
 Menu Back : Background of menu
 Select Box : Selected menu
 Sub Menu : Pop-up menu
 Selected Key : Selected key

Operating Procedure

Graphic Menu Display

1. Press the **MISC** key.
2. Press the “**System Config**” soft key to display the system configuration setting menu.
3. Press the “**Graph Color**” soft key to display the graphic menu.
4. Press the **SELECT** key to display the mode menu.
5. Keep pressing the **SELECT** key until “**User**” is selected.

Selecting “**Default**” sets the color to the default color.

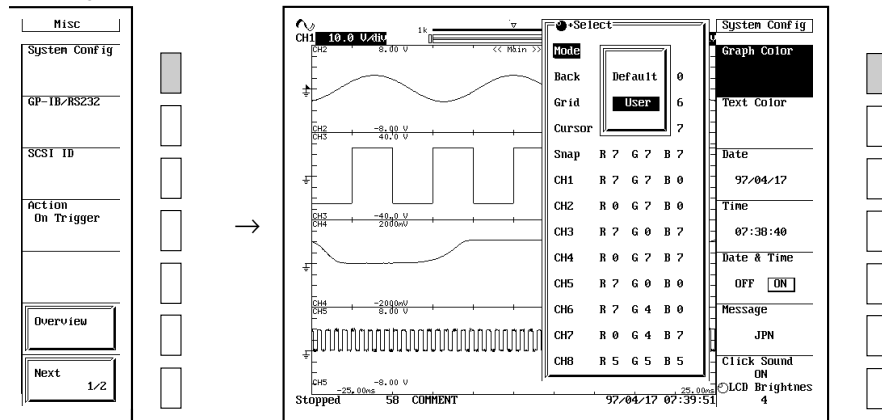

Selecting graphic items (Only if “User” is selected)

6. Turn the jog shuttle to move the cursor to the desired item.
7. Press the **SELECT** key to display the color proportion menu.
8. Turn the jog shuttle to select a desired value from “0” to “7.”
9. Press the **SELECT** or **ESC** key to confirm the selection.
10. Repeat steps 6 to 9 until you have made a color setting for all the desired items.

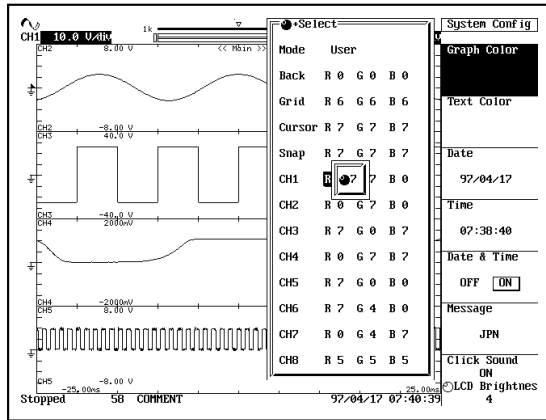

Selecting text items

11. Press the “Text Color” soft key to display the text menu.
12. Press the **SELECT** key to display the mode menu.
13. Keep pressing the **SELECT** key to select “Default1,” “Default2,” “Default3” or “User.”
Selecting “Default1,” “Default2” or “Default3” sets the color to the default color.
14. Set the color for each text item as you did for the graphic items in steps 6 to 10.

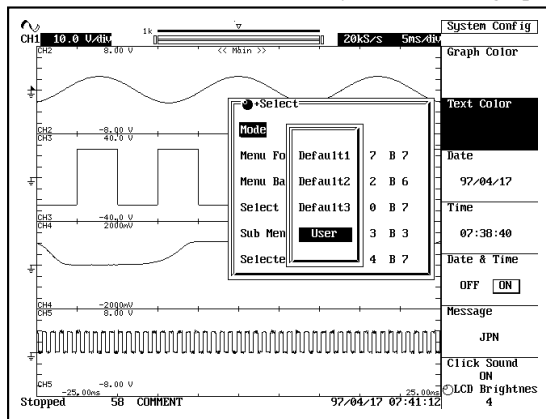

13.2 Setting the Message Language, Click Sound and Brightness of the LCD

Function

Message language selection

When there is an error, a message will appear. The language used to display the messages can be selected from the following combinations specified by the model code.
Japanese or English ; English or German ; English or French ; English or Italian
The code No. for each error message is the same whether messages are in English, in French, in German or in Italian. For description of each message, refer to page 14-2.

Setting the intensity of the LCD

The brightness of the liquid crystal display can be adjusted. The darkest setting is “-1,” and the brightest setting is “7.”

The click sound ON/OFF

This function enables you to decide whether or not a click sound is made when the jog shuttle is turned. This function is set to ON as the default.

Operating Procedure

1. Press the **MISC** key.
2. Press the “**System Config**” soft key to display the system configuration setting menu.

Message language selection

3. Press the “**Message**” soft key to select either “**JPN**” “**ENG**,” “**FRN**,” “**GER**,” or “**ITL**.”
Depending on the suffix code of your instrument (help language), some languages may not be supported.

The click sound ON/OFF

3. Press the “**Click Sound**” soft key to select either “**ON**” or “**OFF**.”

Setting the intensity of the LCD

3. Set the value for the “**LCD Brightnes**” with the jog shuttle.

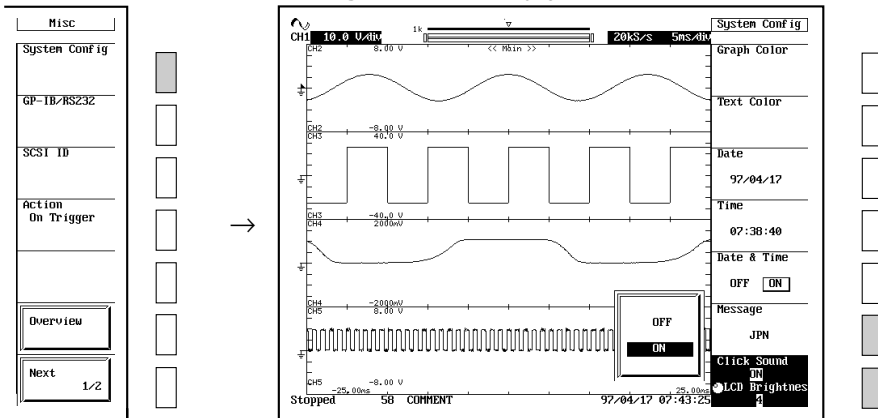

13.3 Setting the Screen Saver Function

Function

The instrument automatically switches to the screen saver display if no key input is received for the specified time. The screen will return to normal display when you press any key.

Available time settings are as follows : OFF (never use screen saver), 10 min, 30 min, 1 h, 2 h, 5 h

Operating Procedure

1. Press the **MISC** key.
2. Press the “**NEXT 1/2**” soft key, and then press the “**Others**” soft key.
3. Turn the jog shuttle to set the time.

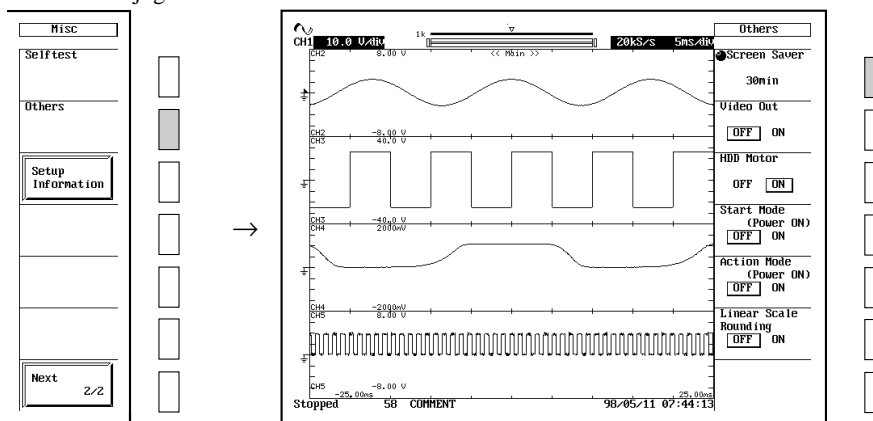

13.4 Setting the Action on Trigger

≡ For a description of this function, refer to page 1-24. ≡

Function

Action on Trigger mode

ON : If the waveform acquisition is started with the **START/STOP** key, the specified action is executed when the trigger condition is satisfied with the normal mode trigger regardless of the trigger mode setting.

OFF : Action is not executed even when the trigger condition is satisfied.

Set Action

The specified action from the following choices are executed every time the trigger is activated.

Hard copy : Output the screen image data to the device selected by the “Copy to” item in the Copy setup menu. (Printer, Centro, GP-IB, RS-232, FD, SCSI, or HD).

Save : Save the waveform data to the device selected in the File menu. (FD, SCSI, or HD).

Buzzer : Sound the buzzer.

Number of operations : Sequence

Single : Perform the action once only.

Cont : Execute the action repeatedly. (The number of actions cannot exceed the acquisition count set under acquisition mode. If the count is set to Infinite, actions can repeat until acquisition is stopped.)

Execute/Stop Action on Trigger

Action on Trigger is executed when the waveform acquisition is started with the **START/STOP** key.

To stop the action, stop the acquisition by pressing the **START/STOP** key.

File names used for data saves to FD, HD, and SCSI

All filenames consist of a five-letter common part followed by a three-digit value (starting from 000) indicating the file generation sequence. The common part of the filename is selected as follows.

Hard Copy : Filename setting in the Copy setup menu. (See Section 10.6)

Save : Filename setting in the File setup menu. (See Section 11.6)

Notes about file saving (If Set Action is “Save”)

- Data is saved to the device selected by the Media item in the FILE menu. (Note that you must press the “Set Media” soft key to change the selection.)
- The number of files that can be saved
 - FD : 100 files
 - SCSI, HD : Maximum 1000 file sets per high-level directory. (Please create the required number of high-level directories ahead of time using the Add Dir function; see Section 11.5).
When the instrument files one directory, it moves to the next.

Setting the execution mode of the “action on trigger” at power ON

You can select whether or not to make valid the “Mode” setting of the “action on trigger” when the power turns ON. For example, you can set this mode to ON if you want to execute the “action on trigger” after the power failure.

ON : When the power turns ON, set the “Mode” of the “action on trigger” to the setting that existed before the power turned OFF.

OFF : Set the “Mode” of the “action on trigger” to OFF when the power turns ON.
Initial setting is OFF.

Points to note when setting the Action on Trigger

- While the Action on Trigger is in progress, all key operation besides the **START/STOP** key are invalid.
- When the acquisition mode is “Average” or “Sequence,” Action on Trigger cannot be used.
- Action on Trigger cannot be used during realtime recording.

Operating Procedure

1. Press the **MISC** key.
2. Press the **“Action on Trigger”** soft key to display the Action on Trigger setting menu.
3. Press the **“Mode”** soft key to select **“ON”** or **“OFF.”**
4. Press the **“Set Action”** soft key to display the action selection menu.
5. Move the cursor to the item you wish to turn ON with the jog shuttle, and press **SELECT** key to turn it ON.
6. Repeat step 5 as necessary.
7. Press the **“Sequence”** soft key to select **“Single”** or **“Cont.”**

Executing Action on Trigger

8. Press the **START/STOP** key to start acquisition.

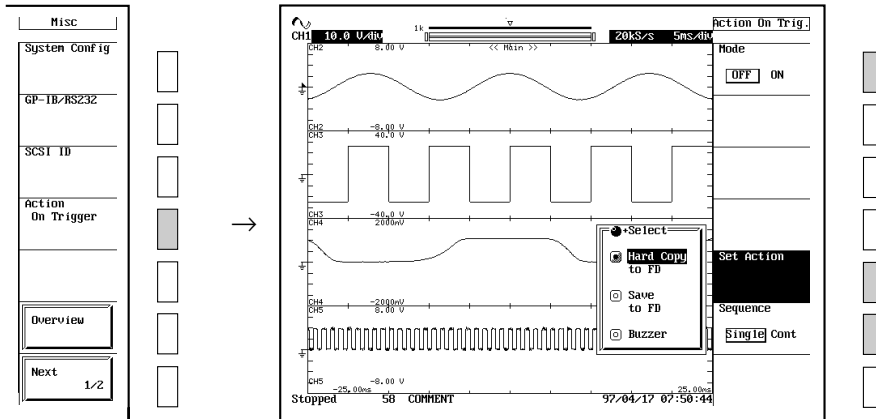

Setting the execution mode of the action on trigger at power ON

2. Press the **“Next”** soft key to display the **“Next2/2”** menu. Then, press the **“Others”** soft key.
3. Press the **“Action Mode(Power ON)”** soft key and select **“ON”** or **“OFF.”**

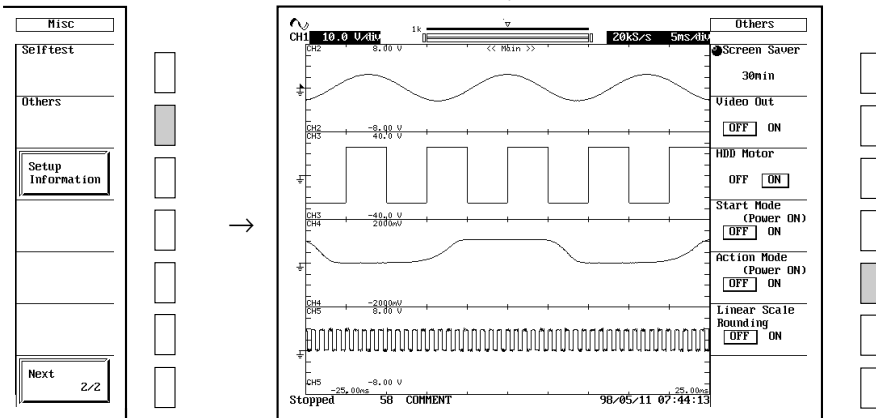

14.1 Breakdown Troubleshooting

Corrective Action to be Taken in the case of an Abnormality

- If a message appears on the screen, refer to the following pages.
- If maintenance service is required, or if the instrument still does not operate properly even if the proper corrective action has been taken, contact your nearest YOKOGAWA representatives, listed on the back cover of this manual.

| Symptom | Possible Cause | Corrective Action | Reference Page |
|--|--|---|-------------------------------|
| The power does not come ON. | The source voltage is outside the rated range. | Connect the instrument to a source of the correct voltage. | 3-4 |
| Nothing is displayed. | Inappropriate screen color has been selected. | Select an appropriate screen color. | 13-1 |
| Display is odd. | Instrument is abnormal. | Turn ON the power again. | 3-5 |
| Keys do not function. | Instrument is in remote mode. | Press the LOCAL key to activate local mode. | 2-3 |
| | Other causes | Perform key operation check. If service is required. | 14-6 the check fails, |
| | | | maintenance |
| No trigger is caused. | Trigger settings are not correct. | Make correct trigger settings. | Chapter 6 |
| Measured values are odd. | Insufficient warm-up | Allow instrument to warm up for | - |
| | | | at least 30 minutes |
| | | is turned ON. | |
| | No calibration has been performed. | Perform calibration. | 4-9 |
| | Passive probe's phase has not been corrected. | Perform phase correction properly. | 3-15 |
| | Incorrect probe attenuation | Set the correct attenuation. | 5-7 |
| | Offset voltage is in use (vertical axis position). | Set the offset voltage to "0". | 5-11 |
| | Other causes | Perform calibration. If measured values are still odd, maintenance service is required. | 4-9 |
| No data is output to printer. | Printer head is damaged or worn out. | Maintenance service is required. | - |
| No data is output to plotter. | Plotter is not set to listen-only mode. | Set the plotter to listen-only mode. | - |
| Data cannot be saved to a medium. | Medium has not been formatted. | Format the medium. | 11-4 |
| | Medium is write-protected. | Remove write-protection. | - |
| | Insufficient space on medium. | Delete unnecessary files or use another medium. | 11-16 |
| Cannot recognize media. | Cable is not connected. | Connect the cable. | 11-3 |
| | SCSI ID number is incorrect. | Set the correct SCSI ID number. | 11-19 |
| | Media format is incorrect. | Format the medium. | 11-4 |
| | Medium is damaged. | - | - |
| Settings and operation control are not possible via the GP-IB interface. | The addresses set in the program differ from those used by the instrument. | Make sure that the same addresses are set for both program and instrument. | Communication Interface |
| | Instrument is not being used according to the electrical and mechanical specifications | Use the instrument according to these specifications. | User's Manual (IM 701820-11E) |

14.2 Error Messages and Corrective Actions

Error Messages

An error message may appear during operation. This section describes the meaning of each message and the corrective action to be taken. Messages can be displayed in either Japanese or English (refer to page 13-3). If the message indicates that maintenance service is required, contact your nearest YOKOGAWA representative listed on the back cover of this manual.

In addition to the messages given below, there are also some other communications related error messages (0 to 500). These messages are described in the Communication Interface User's Manual.

Error in Execution (600 to 799)

| Code | Error Description | Corrective Action | Reference Page |
|---------------------------|--|--|----------------|
| 601 | Invalid file name or SCSI ID. | Check filename or SCSI ID. | 11-19 |
| 602, 603 | No SCSI device or no media inserted. | Check the SCSI device connection and the SCSI ID, and make sure that the storage medium is inserted (if applicable). | 11-3, 11-19 |
| 604 | Media failure. | Check the storage medium. | – |
| 605 | File not found. | Check the filename and the storage medium. | Chapter 11 |
| 606 | Media is protected. | Set the disk's (medium's) write protect switch to OFF. | – |
| 607 | Media failure. | Check the storage medium. | – |
| 608 to 610 | Invalid file name or SCSI ID. | Check filename or SCSI ID. | 11-19 |
| 611, 612 | Media full. | Delete unnecessary file(s) or use another disk. For the necessary capacity (bytes), refer to the reference page numbers. | 11-8 11-12 |
| 613 | File system failure. | Check using another disk. If the same message still appears, maintenance service is required. | – |
| 614 | File is protected. | Delete the file's "*" (write disable mark). | 11-16 |
| 615 | Physical format error. | Reformat the medium. If the same error occurs, the instrument is probably unable to execute a format on this medium. | 11-4 |
| 616 to 620 | File system failure. | Check using another disk. If the same message still appears, maintenance service is required. | – |
| 621 | File is damaged. | Check the file. | – |
| 622 to 641, 656 to 663 | File system failure. | Check using another disk. If the same message still appears, maintenance service is required. | – |
| 642 | No media exists in SCSI device. | Check that the storage medium is correctly inserted in the SCSI device. | 11-7 |
| 646 to 653 | Media failure. | Check the medium. | – |
| 654 | Media failure. | Use a floppy disk of a format supported by the instrument. | 11-4 |
| 665 | Cannot load this file format. | Files stored on other models (DL/AG series) cannot be loaded. | – |
| 666 | File is now being accessed. Wait a moment. | Execute after access is made. | – |
| 667 | Cannot be executed while running. | Press the START/STOP key to stop acquisition. | 4-6 |
| 668 | Cannot find '.HDR' file. | Check the file. | 11-4 |
| 669 | Cannot find '.INF' file. | Check the file. | 11-4 |
| 670 | Displayed channel does not exist. | Turn ON the display of the appropriate channel. | 5-1 |
| 671 | Save data not found. | Check for presence of data. | 11-8 |
| 672 | This model does not have the SCSI interface. | – | 2 |
| 673 | SCSI controller failure. | Maintenance service is required. | – |
| 680 | Illegal printer head position. | Set the release arm to the "HOLD" position. | 10-2 |
| 681 | Paper empty. | Load a roll chart. | 10-2 |
| 682 | Printer over heat. | Turn OFF the power immediately. Maintenance service is required. | – |
| 683 | Printer over heat. | Turn OFF the power immediately. Maintenance service is required. | – |
| 685 | Printer time out. | Maintenance service is required. | – |
| 686 | Centronics printer error. | Turn the power of the printer from OFF to ON. | – |
| 687 | Centronics printer is off line. | – | – |
| 688 | Centronics printer is out of paper. | – | – |

| Code | Error Description | Corrective Action | Reference Page |
|----------|--|---|------------------|
| 689 | Centronics printer is in use. | – | – |
| 690 | Cannot detect Centronics printer. | Turn ON the printer. Check connectors. | – |
| 701, 702 | Cannot be executed while running. | Press the START/STOP key to stop acquisition. | 4-6 |
| 703 | There is no undo-data. | Undo is not possible since data which was present before initialization and auto set-up is now not available. | 4-3 4-4 |
| 704 | Cannot be executed while running. | Press the START/STOP key to stop acquisition. | 4-6 |
| 707 | Can't start while data out. Wait a moment. | Wait until output is completed. | 4-6 |
| 708 | Can't data out while running. | Press the START/STOP key to stop acquisition. | 10-4, 10-7, 10-9 |
| 709 | Can't detect listener. Check GP-IB connector. | Check whether the GP-IB cable is connected properly. | – |
| 710 | File not found. | Check the file. | – |
| 711 | Cannot access file while hard-copying. | Wait until output is completed. | – |
| 712 | Cannot compress this hardcopy image. | Set compression OFF. | 10-12 |
| 713 | Calibration failure.Failed CH: * | Maintenance service is required. (The CH number which failed the calibration is displayed at the * mark). | – |
| 715 | Realtime print possible for 500 ms/div or slower. | – | 1-14, 7-9 |
| 716 | Realtime store possible for 1 s/div or slower. | – | 1-14, 7-11 |
| 717 | Too many channels for the current T/div setting to realtime store. | Decrease the number of channels by turning them OFF. | 1-14, 7-11 |
| 718 | Too many channels for the current Store Length to realtime store. | Decrease the number of channels by turning them OFF or shorten the Store Length. | 1-14, 7-11 |
| 724 | Balancing failed. Problematic channel: * * indicates the channel number of the channel for which automatic balancing failed. | Check the strain gauge/strain gauge bridge connections and the bridge voltage/gauge factor settings. Then, execute the balancing again. | 3-16, 5-19 |
| 725 | Cannot be executed. Acquisition not active. | Press the START/STOP key to start acquisition. | 4-6 |

Error in Setting (800 to 899)

| Code | Error Description | Corrective Action | Reference Page |
|------|---|--|----------------------------|
| 800 | Illegal date-time. | Set the correct date and time. | 3-6 |
| 801 | Illegal file name. | The file name contains characters which are not allowed or the file name is not a valid MS-DOS file name. Enter another file name. | 4-2 |
| 802 | Max number of selection is 8 (except Histogram). | The number of waveform parameters which can be measured automatically is limited to a maximum of eight. | 9-5, 9-8 |
| 803 | Turn off accumulate-mode to enter history menu. | It is not possible to activate the history menu by pressing the HISTORY key during accumulation. | 8-5 |
| 804 | Cannot change this parameter while running. | Press the START/STOP key to stop acquisition. | 4-6 |
| 809 | Cannot change edge for status other than X. | Set the state of the channel corresponding to condition A to "X". | 6-14 |
| 813 | Set Items in measure menu. | Set appropriate measurement items. | 9-5, 9-6 |
| 814 | Duplicated Name. | Change the label string. | 8-9, 11-8 |
| 816 | Cannot turn off with the current record length. Please Change record length. | Reduce the record length. | 7-1 |
| 817 | Cannot change. | Go to X-Y menu and change the XTrace. | 8-10 |
| 819 | Cannot change when Channel Display is OFF or Math settings are invalid. | Set the channel display ON or make appropriate Math settings. | 5-1 Sections 9.5 to 9.9 |
| 823 | Cannot change while running. | Press the START/STOP key to stop acquisition. | 4-6 |
| 824 | Cannot change with the current acq mode. Please change acq mode. | Set the acquisition mode to Normal. | 7-4 |
| 827 | Illegal computing equation. | Input a correct computing equation. | 9-19 |
| 830 | Cannot set anything other than Low Pass for a Gaussian filter. | Change the Filter Type to another filter besides Gaussian. | 9-20, 9-22 |
| 831 | Cannot execute Auto Set-up on a channel which has a logic input module installed. | – | 4-4 |
| 832 | Cannot set the edge on the logic module. | – | 6-14 |
| 833 | Cannot set logic module to B pattern. | – | 6-10, 6-12, 6-17 |
| 834 | Duplicate SCSI ID. | Set different ID numbers. | 11-19 |
| 835 | Cannot change settings while realtime printing or realtime recording. | Stop printing or recording. | 7-10, 7-12 |
| 836 | Cannot change settings during Action On Trigger. | Stop the Action On Trigger. | 13-5 |
| 837 | Cannot set the channels which do not have modules installed. | – | – |
| 838 | This setting is invalid for channels where a strain module is not installed. | Install the strain module into the corresponding CH. | 3-8 |

14.2 Error Messages and Corrective Actions

Error in System Operation (900 to 908, 912 to 914, 917 to 918)

| Code | Error Description | Corrective Action | Reference Page |
|------|---|--|----------------|
| 900 | No response from sub system. Time out ! | Maintenance service is required. | – |
| 901 | Failed to backup setup data. | Maintenance service is required. Will initialize. Backup battery may be low. | – |
| 902 | System RAM failure. | Maintenance service is required. | – |
| 903 | System ROM failure. | Maintenance service is required. | – |
| 904 | System RAM failure. | Maintenance service is required. | – |
| 905 | System failure. | Maintenance service is required. | – |
| 906 | Fan stopped. | Turn OFF the power immediately. Maintenance service is required. | – |
| 907 | Backup battery is flat. | Maintenance service is required to replace the back-up battery. | – |
| 908 | Inside temperature is too high. | Turn OFF the power immediately. Maintenance service is required. | – |
| 912 | Fatal error in Communication-driver. | Maintenance service is required. | – |
| 913 | Fatal error in HP-GL compiler. | Maintenance service is required. | – |
| 914 | Time out occurs in Communication. | Maintenance service is required. | – |
| 917 | No module installed. | Install the module. | 3-7 |
| 918 | Turn ON the internal hard disk motor. | – | 11-2 |

Error in self test (909 to 911, 915 to 916)

| Code | Error Description | Corrective Action | Reference Page |
|------|---|----------------------------------|----------------|
| 909 | Illegal SUM value. | Maintenance service is required. | – |
| 910 | RAM read/write error. | Maintenance service is required. | – |
| 911 | Memory bus error. | Maintenance service is required. | – |
| 915 | EEPROM read error. EEPROM may be damaged. | Maintenance service is required. | – |
| 916 | EEPROM write error. EEPROM may be damaged. | Maintenance service is required. | – |

Note

When the message indicates that maintenance service is required, initialize the instrument again to ascertain whether the problem remains.

14.3 Self-Diagnostic Test (Self Test)

Function

Memory test

This test is designed to check the internal ROM and RAM. The ROM and RAM are functioning correctly if “Pass” is displayed, and are not functioning correctly if “Failed” is displayed. In this case, contact your dealer or nearest YOKOGAWA representative listed on the back cover of this manual.

System : Checksum of the system ROM, read/write check of the Main Memory and the Backup Memory.

Acq RAM : Read/write check of acquisition RAM

Key test

This test is designed to check each of the front panel keys. A key is functioning correctly if the correct name of the key is displayed when the key is pressed. If it is not, contact your dealer or nearest YOKOGAWA representative as listed on the back cover of this manual.

Printer test

This test is designed to check the optional built-in printer. The printer is functioning correctly if gray shading is printed properly. If it is not, contact your dealer or nearest YOKOGAWA representative as listed on the back cover of this manual.

Floppy Disk Drive Test

Tests whether the floppy disk drive is normal. If “Failed” is displayed after executing the test, contact your nearest YOKOGAWA dealer listed on the back cover of this manual.

Hard Disk Drive Test (option /C8 only)

Tests whether the hard disk is normal. If “Failed” is displayed after executing the test, contact your nearest YOKOGAWA dealer listed on the back cover of this manual.

Operating Procedure

Displaying the self test menu

1. Press the **MISC** key.
2. Press the “**Next 1/2**” soft key to display the self test soft key menu.
3. Press the “**Self test**” soft key to display the self test menu.

Proceed to step 4 for the memory test, step 9 for the key test, or step 13 for the printer test.

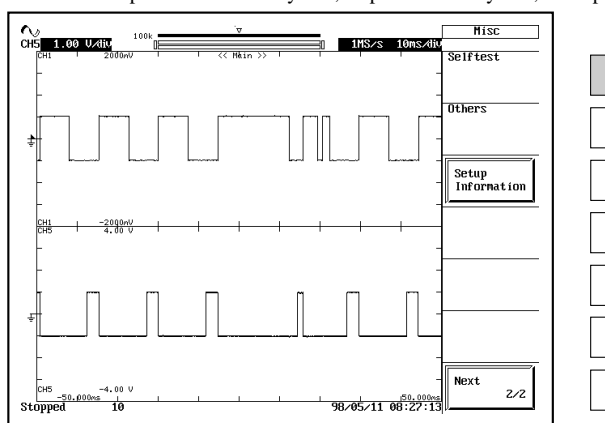

Displaying the memory test menu

4. Press the “**Test Item**” soft key to display the test item menu.
5. Keep pressing the “**Test Item**” soft key until “**Memory**” is selected.

Selecting the memory to be tested and executing memory test

6. Press the “**Memory Test**” soft key to display the memory item menu.
7. Keep pressing the “**Memory Test**” soft key to select “**System**” or “**ACQ RAM.**”
8. Press the “**Exec**” soft key to start the memory test.

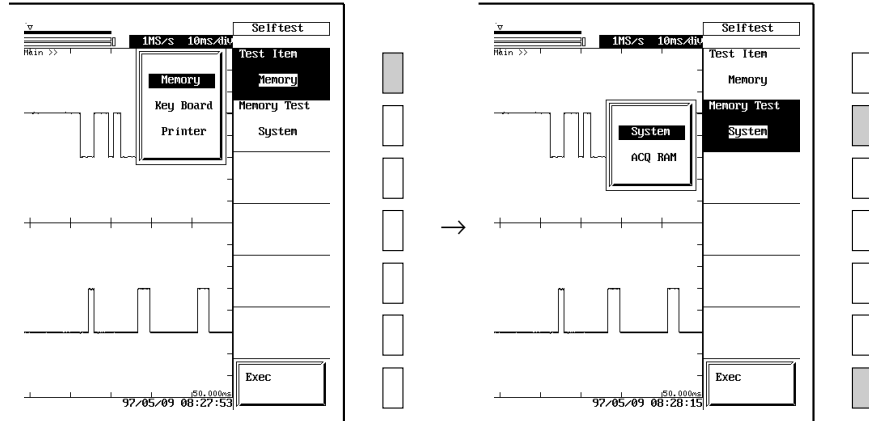

Executing the key test

9. After step 3, press the “**Test Item**” soft key to select “**Key Board.**”
10. Press the “**Exec**” soft key to start the key test.
11. To stop the key test, press the **SHIFT+ESC** key.

Executing the printer test

12. After step 3, press the “**Test Item**” soft key to select “**Printer.**”
13. Press the “**Exec**” soft key to start the printer test.

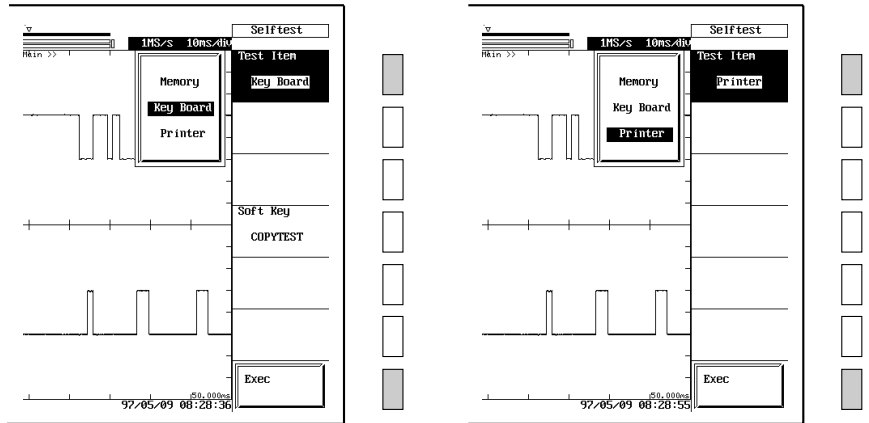

Executing the floppy disk drive test

14. Insert a formatted floppy disk (1.44 MB or 1.2 MB).
15. After step 3, press the “**Test Item**” soft key to select “**FDD.**”
16. Pressing the “**Exec**” soft key will start the test.

Executing the hard disk drive test

17. After step 3, press the “**Test Item**” soft key and select “**HDD.**”
18. Pressing the “**Exec**” soft key will start the test.

Note

- If a floppy disk is not inserted when executing the floppy disk drive test, “Failed” is displayed.
- If the power of the internal hard disk is turned OFF (HDD Motor to OFF) when executing the hard disk drive test, “Failed” is displayed.
- Back up the data in the floppy disk or the hard disk as a safety measure.

14.4 Checking the System Condition

Function

Displaying the system condition

Use this function to view the system status: firmware version, machine model, and installed options. The screen appearance is illustrated below.

Displaying setup information

Lists the various settings of horizontal and vertical axes, trigger, and acquisition mode of waveforms.

Operating Procedure

1. Press the **MISC** key.

Display the system condition

2. Press the “**Overview**” soft key to display the overview screen.

Pressing any key will turn OFF the overview screen.

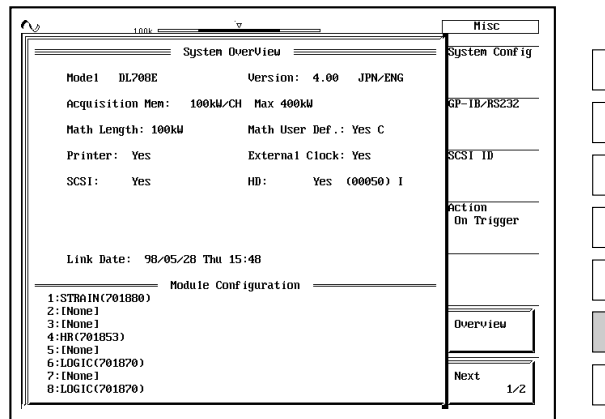

Display setup information

2. Press the “**Next**” soft key to display the “**Next 2/2**” menu.
3. Press the “**Setup information**” soft key to display the screen with the list of setup information. Then, press any key to clear the list screen.

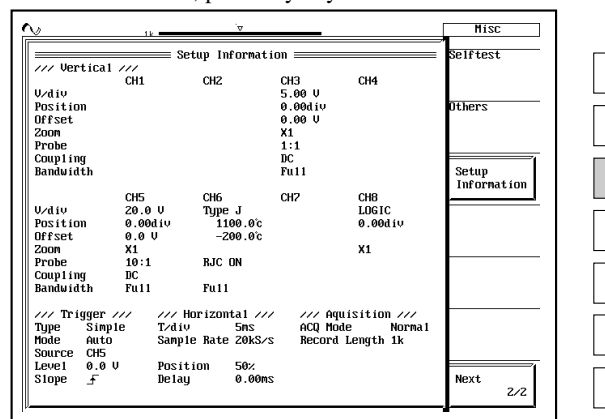

14.5 Warranties on Parts

The 3-year warranty applies only to the main unit of this instrument (starting from the day of delivery) and doesn't cover any other items nor expendable items (items which wear out). Contact your nearest Yokogawa sales representative for replacement parts. Addresses may be found on the back cover of this manual.

| Parts name | Replacement interval |
|-------------------|---|
| Built-in printer | after printing 120 rolls (parts No. B9850NX) continuously |

| Parts name | Warranty Period |
|--------------------|---|
| Internal hard disk | 1 year after the date of purchase(actual data excluded) |

15.1 Input Section

| Item | Specifications |
|-----------------------|---|
| Type | Plug-in input |
| Number of slots | 8 (Various types of modules can exist simultaneously) |
| Maximum record length | 100 kW/CH : 400 kW 1 MW/CH/(M1 option) : 4 MW 2 MW/CH/(M2 option) : 8 MW 4 MW/CH/(M3 option) : 16 MW |

15.2 Trigger Section

| Item | Specifications |
|-----------------------------|--|
| Trigger mode | Auto, Auto-level, normal |
| Trigger source | CH1 to CH8, LINE, EXT (LINE and EXT are available only on simple trigger) |
| Trigger hysteresis | Select from ± 0.1 div/ ± 0.5 div/ ± 1 div of the trigger level |
| Trigger level setting range | CH1 to CH8 : ± 4 div from screen center (0.1 div resolution) |
| External-trigger level | CMOS |
| Trigger position | Can be set in 1% resolution, taking the record length to be 100% |
| Trigger delay setting range | 0 to 1 s (500 ns resolution) |
| Holdoff-time range | 0 to 1 s (500 ns resolution) |
| Simple trigger | Edge |
| Trigger slope | Rise, Fall, Rise/Fall (with edge trigger) |
| Enhanced trigger | <p>A\rightarrowB(n) : Trigger occurs nth time condition B becomes true after condition A becomes true. Count : 1 to 255 Condition A : Enter, Exit Condition B : Enter, Exit</p> <p>A Delay B : Trigger occurs first time condition B becomes true after specified delay following condition A true. Delay : 0 s to 1 s (500 ns resolution) Condition A : Enter, Exit Condition B : Enter, Exit</p> <p>Edge on A : Trigger occurs on Edge OR condition if condition A is true. Edge OR : Trigger occurs on Edge OR condition.</p> <p>B>Time : Trigger occurs if condition B lasts longer than specified time. Time : 200 ns to 1 s (100 ns resolution)</p> <p>B<Time : Trigger occurs if condition B lasts less than specified time. Time : 200 ns to 1 s (100 ns resolution)</p> <p>B Time Out : Trigger occurs when condition B has held true for specified time. Time : 200 ns to 1 s (100 ns resolution)</p> <p>Window : Trigger occurs when Channel 1 trigger-source level enters or exits voltage range. (User selects entry or exit trigger.) OR trigger across multiple channels possible (Window OR)*</p> <p>Timer trigger* : Date (yy/mm/dd) time (hh/mm) ; time interval (one to 24 hours)</p> <ul style="list-style-type: none"> • Conditions A and B are parallel pattern conditions that are set separately to High, Low, or "Don't care" for each channel (CH1 to CH8) and for EXT input. • The OR condition can be independently set to Rise, Fall or "Don't care" for each channel (CH1 to CH8) and for EXT. • For channels which have the logic input modules installed, set to High, Low or Don't Care on each bit. • Channels which have the logic input module installed cannot set the condition B of A\rightarrowB(n) and of A Delay B; OR of Edge on A; Edge OR; B>Time; B<Time; and Window. However, condition A of A\rightarrowB(n), A Delay B, Edge on A can be set. |

* This function is available on DL708Es with firmware versions 4.00 or later.

15.3 Time Axis

| Item | Specifications |
|--------------------------------|---|
| Time axis range | 500 ns/div to 100 ks/div (1-2-5 steps) |
| Time axis accuracy* | ±0.005% |
| External clock (EXT CLK IN) | Connector type : RCA jack (AUDIO jack) Frequency range : 100 kHz or less Input level : CMOS level Minimum pulse width : 1 μ for High and Low |

* As measured under standard operating conditions (see page 15-6).

15.4 Display

| Item | Specifications |
|---------------------------------|---|
| Display | 10.4-inch color TFT liquid crystal display |
| Screen size | 211.2 mm (width) x 158.4 mm (height) |
| Total picture elements * | 640 x 480 dots |
| Waveform picture elements | 501 x 432 dots |
| Maximum display update interval | 30 times/s (using one channel) 20 times/s (using eight channels) |

* Liquid crystal display may include defects of about 0.02% of all picture elements.

15.5 Functions

Acquisition/display functions

| Item | Specifications |
|-------------------------|---|
| Acquisition mode | Select from five modes: Normal, Averaging, Sequential store, Envelope, Box Average. |
| Record length | 1 kWords, 10 kWords, 40 kWords, 100 kWords, 200 kWords, 400 kWords, 1 MWords, 2 MWords, 4 MWords, 8 MWords, 16 MWords* ¹ |
| Zoom | Can zoom up to 2 horizontal-axis ranges of displayed waveform(s). |
| Display format | 1, 2, 3, 4, 6, or 8 waveform windows |
| Interpolation | Display samples using dot display, "sine" interpolation, or linear interpolation. For dot display, select use of P-P data, thinned data, or all data. |
| Graticule | Select from three graticule types. |
| Auxiliary display items | Select display or nondisplay of scale values, waveform labels, trigger mark, extra window. |
| X-Y display | Select any channel (CH1 to CH8), Math1, or Math2 as X-axis, with all others simultaneously on Y axis. |
| Accumulation | Displays multiple iterations of waveform, in either "persistence mode" or "color-grade mode." |
| Snapshot | Freezes current waveform on screen. |
| Trace clear | Removes currently displayed waveform. |

*1 The maximum record length varies depending on the options.

Vertical/horizontal axis setting functions

| Item | Specifications |
|-----------------------------|--|
| Channel ON/OFF | Independent ON/OFF for each channel (CH1 to CH8). |
| Vertical-axis Expand/reduce | Axis can be expanded or reduced. |
| Input filter | Can be independently set for each module |
| Display inversion | Invert the waveform display with respect to the vertical position. |
| Linear scaling | Set scaling coefficient, offset, and unit separately for each channel (CH1 to CH8). |
| Roll mode | 100 ms/div to 100 ks/div, and the sample rate is 100 kS/s or less (excluding a portion of the waveform acquisition methods.) |

Analysis Functions

| Item | Specifications |
|---|--|
| Cursor measurement function | Allows selection of cursor type from Marker, Horiz, Vert, H&V, and UserDefine. |
| Automatic measurement of waveform parameters function | Measures the following waveform parameters automatically. P-P, Max, Min, High, Low, Ave, Rms, Amp, StdDev, +Oshot, -Oshot, Rise, Fall, Freq, Period, +Duty, -Duty, +Width, -Width, RDelay, FDelay, Int1TY, Int2TY, Int1XY, Int2XY and Histo |
| Computing functions* ¹ | Addition, subtraction and multiplication, binary codes, phase shift, power spectrum, DA |
| Use defined computation (Optional) | The following operators can be combined in any way to set the computing equation. ABS, SQR, LOG, EXP, BIN, PWHH, PWHL, PWLH, PWLL, PWXX, SIN, COS, TAN, ATAN, MEAN, DIF, DDIF, INTG, IINTG, PH, HLBT, P2, P3, FILT1, FILT2, F1* ² , F2* ² LS-, RS-, PS-, PSD-, TF-, CH-, PHASE, REAL, IMAG, LOGMAG, MAG |

*1 The maximum record lengths that can be computed are 100 kW when using Math1 only and 50 kW when using Math1 and 2.

*2 This function is available on DL708Es with firmware versions 4.00 or later.

Screen Data Output Functions

| Item | Specifications |
|--|--|
| Built-in printer/Printer with Centronics interface | Output the hard copy of the screen in Normal or Long format. |
| GP-IB/RS-232 interface | Output data formats : HP-GL, PostScript, ThinkJet, TIFF, BMP |
| Floppy disk, Internal HDD, SCSI device | Output data formats : HP-GL, PostScript, ThinkJet, TIFF, BMP |

Data Storage Functions

| Item | Specifications |
|---------------------------------|--|
| History memory | Up to 1000 acquisition data records can be automatically stored (for /M1, /M2 or /M3 model). |
| Floppy/Internal HDD/SCSI device | Save and restore waveform data, settings, other data. |

Other Functions

| Item | Specifications |
|------------------------------|--|
| Initialization function | Automatically resets key settings to the factory settings. |
| Auto set-up function | Automatically sets key settings to the optimum values for the input signals. |
| Calibration | The calibration items : Ground level offset, A/D converter gain |
| Environment setting function | Allows setting of screen color, date/time, message language, click sound ON/OFF. |
| COMP signal output function | Outputs a square calibration waveform signal (1 V _{p-p} ±10%, 1 kHz±10%) from the COMP terminal on the front panel. |
| Overview function | Shows system configuration. |
| Self test function | Allows memory test, key test, FDD, Internal HDD, and printer test. |
| Help function | Displays help about settings. |

15.6 External Trigger Input/Output, Video Signal Output

| Item | Specifications |
|--|--|
| External trigger input*1 (TRIG IN) | Connector type : RCA jack Input level : CMOS Minimum pulse width : 1 μ s Logic : Rising edge, falling edge, rising/falling edge Trigger delay time : Within (2 μ s + 1 sample period) |
| Trigger output (TRIG OUT) (See external clock input in section 15.3) | Connector type : RCA jack Output level : CMOS Output logic : $\overline{\square}$ (negative logic) Output delay time : Within (1 μ s + 1 sample period) Output hold time : 200 ns min. for low level |
| Video signal output (VIDEO OUT) | Connector type : D-Sub 15-pin receptacle Output type : VGA compatible |

15.7 GP-IB Interface

| Item | Specifications |
|--|---|
| Electrical and mechanical specifications | Conforms to IEEE St'd 488-1978 (JIS C 1901-1987). |
| Interface functions | SH1, AH1, T5, L4, SR1, RL1, PP0, DC1, DT0, C0 |
| Protocol | Conforms to IEEE St'd 488.2-1987. |
| Code | ISO (ASCII) code |
| Mode | Addressable/Talk only mode |
| Address setting | Listener and talker addresses 0 to 30 are settable. |
| Remote mode clear | Remote mode can be cleared by pressing the SHIFT+CLEAR key (except when local lockout has been set). |

For details refer to the Communication Interface User's Manual (IM 701820-11E).

15.8 RS-232 Interface

| Item | Specifications |
|---------------------------|--|
| Connector type | D-Sub 9-pin |
| Electrical specifications | Conforms to EIA RS-232 Standard. |
| Connection format | point to point |
| Communication format | full duplex |
| Synchronizing format | Start-stop asynchronous transmission. |
| Baud rate | 75/150/300/600/1200/2400/4800/9600/19200 |

For details refer to the Communication Interface User's manual (IM 701820-11E).

15.9 Centronics Interface

| Item | Specifications |
|---------------------------|--|
| Connector type | Centronics interface connector (half-pitch 36-pin) |
| Electrical specifications | Conforms to Centronics specifications. |
| Printers which support | ESC/P, LIPS, PC-PR201, PCL5, BJ-35V, ESC/P raster |

15.10 SCSI Interface

| Item | Specifications |
|---------------------------|---|
| Standard | SCSI (Small Computer System Interface) ANSI X3.131-1986 |
| Connector | Half-pitch 50-pin (pin type) |
| Connector pin assignments | Unbalanced (single end), contains a terminator |

15.11 Built-in Printer

| Item | Specifications |
|-----------------|--|
| Printing system | Thermal line dot method |
| Dot density | 8 dots/mm |
| Paper width | 112 mm |
| Printing width | 104 mm |
| Realtime print | Maximum chart speed is 20 mm/s, can be used when the T/div setting is 500 ms/div or less and the sample rate is 100 kS/s or less |

15.12 Built-in Floppy Disk Drive

| Item | Specifications |
|---------------|------------------------------|
| No. of drives | 1 |
| Drive size | 3.5 inch |
| Capacity | 640 KB/720 KB/1.2 MB/1.44 MB |

15.13 Internal Hard Disk (Optional)

| Item | Specifications |
|--------------------------|---|
| No. of drives | 1 |
| Drive size | 2.1 GB (IBM format) |
| Realtime record | T/div that can be used varies depending on the record length. When 8 channels are used : when T/div is 10 s/div or less (sample rate is 10 kS/s or less) When any 4 channels are used : when T/div is 5 s/div or less (sample rate is 20 kS/s or less) When any 2 channels are used : when T/div is 2 s/div or less (sample rate is 50 kS/s or less) When any 1 channel is used : when T/div is 1 s/div or less (sample rate is 100 kS/s or less) |
| Realtime record capacity | 256 MB |
| Maximum store length | When 8 channels are used : 128 M Word When any 1 channel is used : 16 M Word |

* Can be mounted to a PC (Windows 95) using SCSI.

15.14 General

| Item | Specifications | | | | | | | | | | | | | | | |
|--|---|--------------------|--------------------|--------------------|------|----------|-------------|-------|--------|----------|-----------|-----------|-------|--------|----------|-----------|
| Standard operating conditions | Ambient temperature : 23 ±5°C Ambient humidity : 55 ±10% RH Power voltage and frequency: Less than 1% of the rated voltage/frequency fluctuation: After 30-min or more warm up | | | | | | | | | | | | | | | |
| Storage conditions | Temperature : -20 to 60°C Humidity : 20 to 85% RH (no condensation allowed) | | | | | | | | | | | | | | | |
| Operating conditions | Temperature : 5 to 40°C Humidity : 20 to 80% RH (without a printer) 35 to 80% RH (with a printer) } (No condensation allowed in either case) | | | | | | | | | | | | | | | |
| Storage altitude | 3000 m or below | | | | | | | | | | | | | | | |
| Operating altitude | 2000 m or below | | | | | | | | | | | | | | | |
| Rated supply voltage | 100 to 120 VAC (suffix code -1) 200 to 240 VAC (suffix code -5) | | | | | | | | | | | | | | | |
| Permissible supply voltage range | 90 to 132 VAC (suffix code -1) 180 to 264 VAC (suffix code -5) | | | | | | | | | | | | | | | |
| Rated supply voltage frequency | 50/60 Hz | | | | | | | | | | | | | | | |
| Permissible supply voltage frequency | 48 to 63 Hz | | | | | | | | | | | | | | | |
| Maximum power consumption (using printer) | 250 VA | | | | | | | | | | | | | | | |
| Withstand voltage (between power supply and earth) | 1.5 k VAC for 1 minute | | | | | | | | | | | | | | | |
| Insulation resistance (between power supply and earth) | 10 MΩ or more at 500 VDC | | | | | | | | | | | | | | | |
| External dimensions (details on page 15-8) | Approx. 370 (W) x 260 (H) x 183 (D) mm (with printer cover closed, handles and projections excluded) | | | | | | | | | | | | | | | |
| Weight | Main instrument only (701820) : Approx. 5.3 kg Main instrument + High-Speed Isolation Module (8 channels) : Approx. 6.8 kg Internal Hard Disk (optional) : Approx. 500 g | | | | | | | | | | | | | | | |
| Cooling method | Forced air cooling, air discharged from left side | | | | | | | | | | | | | | | |
| Installation position | Horizontal (when a stand is used), vertical, stacking is not allowed. | | | | | | | | | | | | | | | |
| Battery back-up | Set-up data and internal clock are backed up by a built-in lithium battery. Battery life : Approx. 5 years (at ambient temperature of 23°C) | | | | | | | | | | | | | | | |
| Fuse*1 | <table border="1"> <thead> <tr> <th>location</th> <th>max. rated voltage</th> <th>max. rated current</th> <th>type</th> <th>standard</th> </tr> </thead> <tbody> <tr> <td>Inlet board</td> <td>250 V</td> <td>3.15 A</td> <td>time lag</td> <td>VDE/SEMKO</td> </tr> <tr> <td>CPU board</td> <td>250 V</td> <td>800 mA</td> <td>time lag</td> <td>VDE/SEMKO</td> </tr> </tbody> </table> | location | max. rated voltage | max. rated current | type | standard | Inlet board | 250 V | 3.15 A | time lag | VDE/SEMKO | CPU board | 250 V | 800 mA | time lag | VDE/SEMKO |
| location | max. rated voltage | max. rated current | type | standard | | | | | | | | | | | | |
| Inlet board | 250 V | 3.15 A | time lag | VDE/SEMKO | | | | | | | | | | | | |
| CPU board | 250 V | 800 mA | time lag | VDE/SEMKO | | | | | | | | | | | | |
| Accessories | <ul style="list-style-type: none"> • 1 power cord • Printer connecting cable (B9946YY) • Cover plates (8 plates) • Front cover • 1 roll of printer paper (Only on models with "/B5" suffix) • 2 rubber pads, for rear legs • User's manual (this manual) • Operation Guide • Communication Interface Manual | | | | | | | | | | | | | | | |
| Safety standard*2 | <p>Complying standard EN61010(apply for 701820, 701850, 701851, 701852, 701853, 701855, 701856, 701860, 701870, 701880, 700932, 700933, 700986, 700987)</p> <p>Overvoltage category (Installation category) II*3</p> <p>Pollution degree 2*4</p> | | | | | | | | | | | | | | | |
| Emission*2 | <p>Complying standard EN55011-Group1 Class A(apply for 701820, 701850, 701851, 701852, 701853, 701855, 701856, 701860, 701870, 701880, 700932, 700933, 700986, 700987)</p> <p>This product is a Class A (for commercial environment) product. Operation of this product in a residential area may cause radio interference in which case the user is required to correct the interference.</p> <p>Cable requirement</p> <ul style="list-style-type: none"> • External trigger input terminal Use a 3D2W BNC cable*5 and an RCA-BNC converter (YOKOGAWA:366928). Attach a ferrite core (TDK: ZCAT2035-0930A, YOKOGAWA: A1190MN) on each end. • Trigger output / External clock input terminal Same as the external trigger input terminal above. | | | | | | | | | | | | | | | |

| Item | Specifications | | | | | | | | | | | | |
|---|--|--------------------|--|---|--|-------|---|--|---|-------------|--|-------------|---|
| Tests | <ul style="list-style-type: none"> • Video output connector Use a D-Sub 15-pin VGA shielded cable*⁵ and attach a ferrite core (TDK: ZCAT2035-0930A, YOKOGAWA: A1190MN) on each end. • RS-232 connector Use an RS-232 shielded cable and attach a ferrite core (TDK: ZCAT2035-0930A, YOKOGAWA: A1190MN) on each end. • Centronics interface connector Use printer cable*⁵ B9946YY. • SCSI connector (for suffix code -C7, C8) Use a SCSI shielded cable*⁵ and attach a ferrite core (TDK: ZCAT2035-0930A, YOKOGAWA: A1190MN) on each end. <ol style="list-style-type: none"> 1. Main terminal disturbance voltage (EN55011) class A 2. Electromagnetic radiation disturbance (EN55011) class A | | | | | | | | | | | | |
| Immunity* ² | <table border="0" style="width: 100%;"> <tr> <td style="width: 20%; vertical-align: top;">Complying standard</td> <td>EN50082-2:1995(apply for 701820, 701850, 701851, 701852, 701853, 701855, 701856, 701860, 701870, 701880, 700932, 700933, 700986, 700987)</td> </tr> <tr> <td style="vertical-align: top;">Influence in the immunity environment (performance criterion A)</td> <td> <ul style="list-style-type: none"> • Noise increase <ul style="list-style-type: none"> · $\leq \pm 200$ mV, when using 701850 · $\leq \pm 200$ mV, when using 701851 · $\leq \pm 10$ mV, when using 701852 · $\leq \pm 1$ mV, when using 701853 · $\leq \pm 200$ mV, when using 701855 · $\leq \pm 200$ mV, when using 701856 · $\leq \pm 10$ % of FULL SPAN(measurement range), when using 701860 with thermocouples K, E, J, L, N, W · $\leq \pm 20$ % of FULL SPAN(measurement range), when using 701860 with thermocouples T,U,R,S · $\leq \pm 30$ % of FULL SPAN(measurement range), when using 701860 with thermocouples B, KPvsAu7Fe · No influence, when using 701870, 700986 · No influence, when using 701870, 700987 · $\leq \pm 800 \times 10^{-6}$ strain, when using 701880, 700932 · $\leq \pm 800 \times 10^{-6}$ strain, when using 701880, 700933 • Test condition <ul style="list-style-type: none"> · 10 MS/s, 50 mV/div, PeakDetect (Envelope) Mode, 500 Hz BWL, input 50 Ω, when using 701850 · 10 MS/s, 50 mV/div, PeakDetect (Envelope) Mode, 500 kHz BWL, input 50 Ω, when using 701851 · 10 MS/s, 50 mV/div, PeakDetect (Envelope) Mode, input 50 Ω, when using 701852 · 10 MS/s, 5 mV/div, PeakDetect (Envelope) Mode, input 50 Ω, when using 701853 · 10 MS/s, 50 mV/div, PeakDetect (Envelope) Mode, 500 Hz BWL, input 50 Ω, when using 701855 · 10 MS/s, 50 mV/div, PeakDetect (Envelope) Mode, 500 kHz BWL, input 50 Ω, when using 701856 · 10 MS/s, PeakDetect (Envelope) Mode, when using 701860 with thermocouple J · 10 MS/s, PeakDetect (Envelope) Mode, when using 701870, 700986 · 10 MS/s, PeakDetect (Envelope) Mode, when using 701870, 700987 · 10 MS/s, 1000×10^{-6} strain, Bridge Voltage 2 V, PeakDetect (Envelope) Mode, input 120 Ω, when using 701880, 700932 · 10 MS/s, 1000×10^{-6} strain, Bridge Voltage 2 V, PeakDetect (Envelope) Mode, input 350 Ω, when using 701880, 700933 </td> </tr> <tr> <td style="vertical-align: top;">Tests</td> <td> <ol style="list-style-type: none"> 1. Electrostatic discharge (IEC1000-4-2) : 8 kV(air discharge), 4 kV(contact discharge), Criterion B 2. EM-field immunity (IEC1000-4-3) : 80 MHz to 1 GHz, 10 V/m, Criterion A 3. Electrical fast transient/burst (IEC1000-4-4) : 2 kV(AC line), 1 kV(other signal lines), Criterion B 4. HF conducted immunity (IEC1000-4-6) : 0.15 to 80 MHz, 10 Vrms, Criterion A 5. Power frequency magnetic field (IEC1000-4-8) : 50 Hz, 30 A/m, Criterion A </td> </tr> <tr> <td style="vertical-align: top;">Definition of performance criteria A and B</td> <td> <table border="0" style="width: 100%;"> <tr> <td style="width: 20%; vertical-align: top;">criterion A</td> <td>During experiments make sure the above “Influence in the immunity environment” values are being satisfied.</td> </tr> <tr> <td style="vertical-align: top;">criterion B</td> <td>This apparatus continues to operate without hang-up or falling into uncontrollable conditions during the test. No change of actual operating state or stored data is allowed.</td> </tr> </table> </td> </tr> </table> | Complying standard | EN50082-2:1995(apply for 701820, 701850, 701851, 701852, 701853, 701855, 701856, 701860, 701870, 701880, 700932, 700933, 700986, 700987) | Influence in the immunity environment (performance criterion A) | <ul style="list-style-type: none"> • Noise increase <ul style="list-style-type: none"> · $\leq \pm 200$ mV, when using 701850 · $\leq \pm 200$ mV, when using 701851 · $\leq \pm 10$ mV, when using 701852 · $\leq \pm 1$ mV, when using 701853 · $\leq \pm 200$ mV, when using 701855 · $\leq \pm 200$ mV, when using 701856 · $\leq \pm 10$ % of FULL SPAN(measurement range), when using 701860 with thermocouples K, E, J, L, N, W · $\leq \pm 20$ % of FULL SPAN(measurement range), when using 701860 with thermocouples T,U,R,S · $\leq \pm 30$ % of FULL SPAN(measurement range), when using 701860 with thermocouples B, KPvsAu7Fe · No influence, when using 701870, 700986 · No influence, when using 701870, 700987 · $\leq \pm 800 \times 10^{-6}$ strain, when using 701880, 700932 · $\leq \pm 800 \times 10^{-6}$ strain, when using 701880, 700933 • Test condition <ul style="list-style-type: none"> · 10 MS/s, 50 mV/div, PeakDetect (Envelope) Mode, 500 Hz BWL, input 50 Ω, when using 701850 · 10 MS/s, 50 mV/div, PeakDetect (Envelope) Mode, 500 kHz BWL, input 50 Ω, when using 701851 · 10 MS/s, 50 mV/div, PeakDetect (Envelope) Mode, input 50 Ω, when using 701852 · 10 MS/s, 5 mV/div, PeakDetect (Envelope) Mode, input 50 Ω, when using 701853 · 10 MS/s, 50 mV/div, PeakDetect (Envelope) Mode, 500 Hz BWL, input 50 Ω, when using 701855 · 10 MS/s, 50 mV/div, PeakDetect (Envelope) Mode, 500 kHz BWL, input 50 Ω, when using 701856 · 10 MS/s, PeakDetect (Envelope) Mode, when using 701860 with thermocouple J · 10 MS/s, PeakDetect (Envelope) Mode, when using 701870, 700986 · 10 MS/s, PeakDetect (Envelope) Mode, when using 701870, 700987 · 10 MS/s, 1000×10^{-6} strain, Bridge Voltage 2 V, PeakDetect (Envelope) Mode, input 120 Ω, when using 701880, 700932 · 10 MS/s, 1000×10^{-6} strain, Bridge Voltage 2 V, PeakDetect (Envelope) Mode, input 350 Ω, when using 701880, 700933 | Tests | <ol style="list-style-type: none"> 1. Electrostatic discharge (IEC1000-4-2) : 8 kV(air discharge), 4 kV(contact discharge), Criterion B 2. EM-field immunity (IEC1000-4-3) : 80 MHz to 1 GHz, 10 V/m, Criterion A 3. Electrical fast transient/burst (IEC1000-4-4) : 2 kV(AC line), 1 kV(other signal lines), Criterion B 4. HF conducted immunity (IEC1000-4-6) : 0.15 to 80 MHz, 10 Vrms, Criterion A 5. Power frequency magnetic field (IEC1000-4-8) : 50 Hz, 30 A/m, Criterion A | Definition of performance criteria A and B | <table border="0" style="width: 100%;"> <tr> <td style="width: 20%; vertical-align: top;">criterion A</td> <td>During experiments make sure the above “Influence in the immunity environment” values are being satisfied.</td> </tr> <tr> <td style="vertical-align: top;">criterion B</td> <td>This apparatus continues to operate without hang-up or falling into uncontrollable conditions during the test. No change of actual operating state or stored data is allowed.</td> </tr> </table> | criterion A | During experiments make sure the above “Influence in the immunity environment” values are being satisfied. | criterion B | This apparatus continues to operate without hang-up or falling into uncontrollable conditions during the test. No change of actual operating state or stored data is allowed. |
| Complying standard | EN50082-2:1995(apply for 701820, 701850, 701851, 701852, 701853, 701855, 701856, 701860, 701870, 701880, 700932, 700933, 700986, 700987) | | | | | | | | | | | | |
| Influence in the immunity environment (performance criterion A) | <ul style="list-style-type: none"> • Noise increase <ul style="list-style-type: none"> · $\leq \pm 200$ mV, when using 701850 · $\leq \pm 200$ mV, when using 701851 · $\leq \pm 10$ mV, when using 701852 · $\leq \pm 1$ mV, when using 701853 · $\leq \pm 200$ mV, when using 701855 · $\leq \pm 200$ mV, when using 701856 · $\leq \pm 10$ % of FULL SPAN(measurement range), when using 701860 with thermocouples K, E, J, L, N, W · $\leq \pm 20$ % of FULL SPAN(measurement range), when using 701860 with thermocouples T,U,R,S · $\leq \pm 30$ % of FULL SPAN(measurement range), when using 701860 with thermocouples B, KPvsAu7Fe · No influence, when using 701870, 700986 · No influence, when using 701870, 700987 · $\leq \pm 800 \times 10^{-6}$ strain, when using 701880, 700932 · $\leq \pm 800 \times 10^{-6}$ strain, when using 701880, 700933 • Test condition <ul style="list-style-type: none"> · 10 MS/s, 50 mV/div, PeakDetect (Envelope) Mode, 500 Hz BWL, input 50 Ω, when using 701850 · 10 MS/s, 50 mV/div, PeakDetect (Envelope) Mode, 500 kHz BWL, input 50 Ω, when using 701851 · 10 MS/s, 50 mV/div, PeakDetect (Envelope) Mode, input 50 Ω, when using 701852 · 10 MS/s, 5 mV/div, PeakDetect (Envelope) Mode, input 50 Ω, when using 701853 · 10 MS/s, 50 mV/div, PeakDetect (Envelope) Mode, 500 Hz BWL, input 50 Ω, when using 701855 · 10 MS/s, 50 mV/div, PeakDetect (Envelope) Mode, 500 kHz BWL, input 50 Ω, when using 701856 · 10 MS/s, PeakDetect (Envelope) Mode, when using 701860 with thermocouple J · 10 MS/s, PeakDetect (Envelope) Mode, when using 701870, 700986 · 10 MS/s, PeakDetect (Envelope) Mode, when using 701870, 700987 · 10 MS/s, 1000×10^{-6} strain, Bridge Voltage 2 V, PeakDetect (Envelope) Mode, input 120 Ω, when using 701880, 700932 · 10 MS/s, 1000×10^{-6} strain, Bridge Voltage 2 V, PeakDetect (Envelope) Mode, input 350 Ω, when using 701880, 700933 | | | | | | | | | | | | |
| Tests | <ol style="list-style-type: none"> 1. Electrostatic discharge (IEC1000-4-2) : 8 kV(air discharge), 4 kV(contact discharge), Criterion B 2. EM-field immunity (IEC1000-4-3) : 80 MHz to 1 GHz, 10 V/m, Criterion A 3. Electrical fast transient/burst (IEC1000-4-4) : 2 kV(AC line), 1 kV(other signal lines), Criterion B 4. HF conducted immunity (IEC1000-4-6) : 0.15 to 80 MHz, 10 Vrms, Criterion A 5. Power frequency magnetic field (IEC1000-4-8) : 50 Hz, 30 A/m, Criterion A | | | | | | | | | | | | |
| Definition of performance criteria A and B | <table border="0" style="width: 100%;"> <tr> <td style="width: 20%; vertical-align: top;">criterion A</td> <td>During experiments make sure the above “Influence in the immunity environment” values are being satisfied.</td> </tr> <tr> <td style="vertical-align: top;">criterion B</td> <td>This apparatus continues to operate without hang-up or falling into uncontrollable conditions during the test. No change of actual operating state or stored data is allowed.</td> </tr> </table> | criterion A | During experiments make sure the above “Influence in the immunity environment” values are being satisfied. | criterion B | This apparatus continues to operate without hang-up or falling into uncontrollable conditions during the test. No change of actual operating state or stored data is allowed. | | | | | | | | |
| criterion A | During experiments make sure the above “Influence in the immunity environment” values are being satisfied. | | | | | | | | | | | | |
| criterion B | This apparatus continues to operate without hang-up or falling into uncontrollable conditions during the test. No change of actual operating state or stored data is allowed. | | | | | | | | | | | | |

*1 Because the fuses used by this instrument are all inside the case, they cannot be exchanged by the user. If you believe the fuse inside the case is blown, please contact your nearest YOKOGAWA dealer listed on the back cover of this manual.

*2 Emission, immunity and safety standards apply to products manufactured after August 1998 having the CE Mark. For all other products, please contact your nearest YOKOGAWA representative as listed on the back cover of this manual.

*3 “Overvoltage category (Installation category)” describes a number which defines a transient overvoltage condition. It implies the regulation for impulse withstand voltage. “II” applies to electrical equipment which is supplied from the fixed installation like distribution board.

*4 “Pollution degree” describes the degree to which a solid, liquid, or gas which deteriorates dielectric strength or surface resistivity is adhering. “2” applies to normal indoor atmosphere. Normally, only non-conductive pollution occurs.

*5 The cable length is less than 3 m.

15.15 External Dimensions

Main body

Dimensions: mm

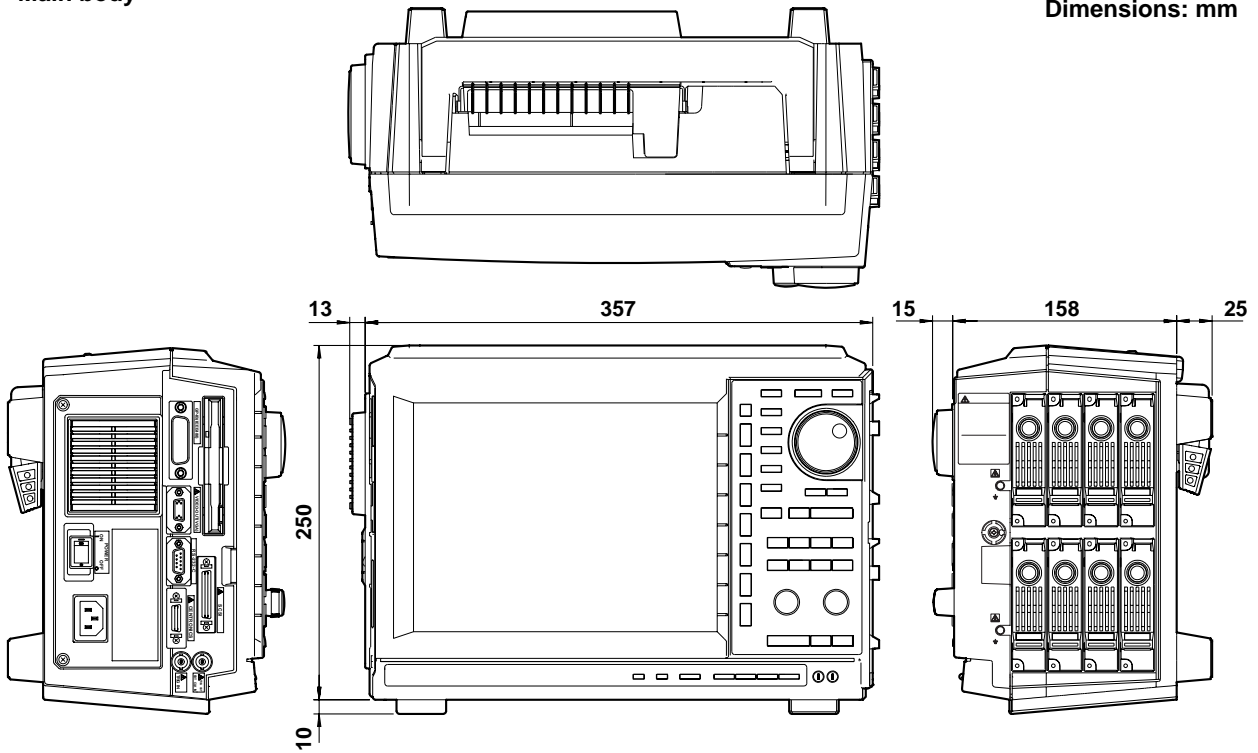

High-Speed Isolation /High-Speed Module (701855/701856)

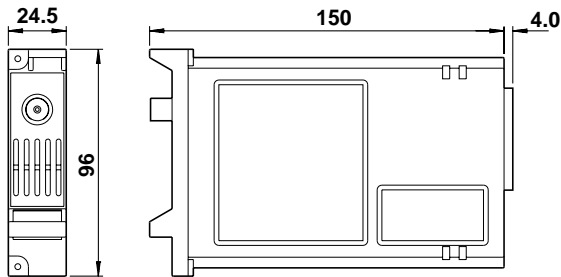

High-Resolution, High-Voltage, Isolation /High-Resolution, High-Voltage, Isolation Module (701852/701853)

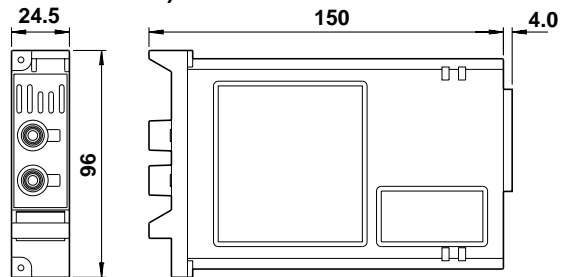

Temperature Module (701860)

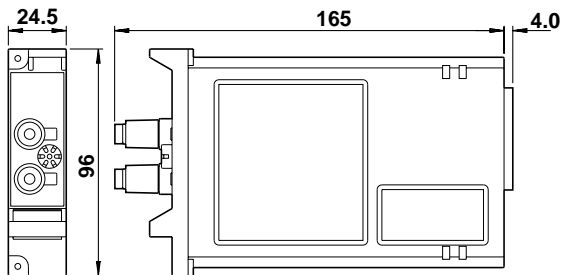

Logic Input Module (701870)

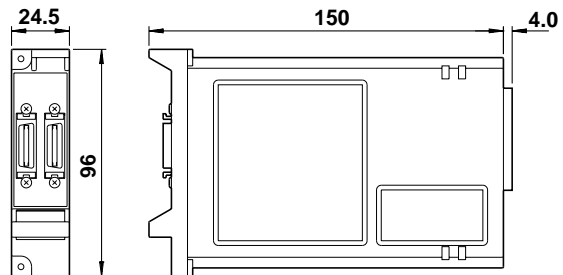

Strain Module (701880)

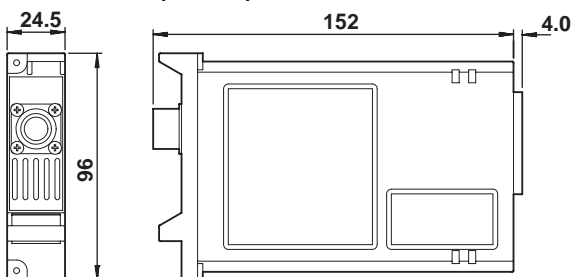

15.16 High-speed Isolation Module (701855)

| Item | Specifications |
|---|--|
| Number of input channels | 1 |
| Input coupling settings | AC, DC, GND |
| Maximum sample rate | 10 MS/s |
| Input format | Isolated unbalanced |
| Frequency characteristics* ¹ (-3 dB point when sine wave of amplitude ± 3 div is input) | DC to 1 MHz |
| Voltage-axis sensitivity setting | 5 mV/div to 20 V/div (1-2-5 steps) when using 700929 : 50 mV/div to 200 V/div (1-2-5 steps) |
| Maximum input voltage (At 1 kHz or less) | main instrument only (across input terminals H and L* ²) 250 V(DC+ACpeak)(CAT I and II, 177 Vrms) combined with 700929 (across probe tips H and L* ⁴) 850 V(DC+ACpeak)(CAT I and II, 600 Vrms) |
| Maximum allowable common mode voltage (At 1 kHz or less) | main instrument only (across input terminal L and earth* ³) 42 V(DC+ACpeak)(CAT I and II, 30 Vrms) combined with 700929 (across probe tip H or L and earth* ⁵) 400 Vrms (CAT I and II) (Specification when the EN61010-1 standard does not need to be satisfied: 600 Vrms) |
| DC offset range (max) (At 1:1 probe attenuation) | 5 mV/div to 50 mV/div : ± 0.5 V 100 mV/div to 500 mV/div : ± 5 V 1 V/div to 5 V/div : ± 50 V 10 V/div to 20 V/div : ± 250 V* ⁶ |
| Vertical (voltage) axis accuracy DC accuracy* ¹ | 10 mV/div to 20 V/div : $\pm (1.5\% \text{ of } 8 \text{ div} + \text{offset voltage accuracy})$ 5 mV/div : $\pm (2.0\% \text{ of } 8 \text{ div} + \text{offset voltage accuracy})$ |
| offset axis accuracy* ¹ | $\pm (0.04\% \text{ of offset voltage range} + 1\% \text{ of setting value})$ |
| Input connector | BNC connector (isolating type) |
| Input impedance | 1 M Ω 1%, approx. 30pF |
| -3dB point for AC coupling used | 10 Hz or less(1 Hz or less when using 700929) |
| Common mode rejection ratio | 80 dB(50/60 Hz) or more (typical* ⁸) |
| Residual noise* ⁷ | Larger of ± 400 μ V or ± 0.06 div(typical* ⁸) |
| Withstand voltage (across input terminal and earth) | 3700 VAC for 1 minute (60 Hz) |
| Isolation resistance (across input terminal and earth) | 500 VDC, 10 M Ω or more |
| A/D conversion resolution | 12 bit (500 LSB/div) |
| Probe attenuation settings | 1:1, 10:1, 100:1 and 1000:1 |
| Bandwidth limit | Select from OFF/500 Hz/5 kHz/ 50 kHz/ 500 kHz |

*1 Measured value under standard operating conditions (refer to page 15-6)

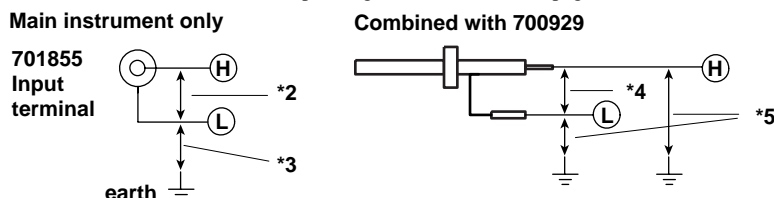

*6 Cannot exceed maximum input voltage

*7 Measured under the following conditions: input block shorted

*8 Typical (or average) value; not guaranteed

15.17 High-speed Module (701856)

| Item | Specifications |
|--|---|
| Number of input channels | 1 |
| Input coupling settings | AC, DC, GND |
| Maximum sample rate | 10 MS/s |
| Input format | Non-isolated unbalanced |
| Frequency characteristics* ¹ (-3 dB point when sine wave of amplitude ± 3 div is input) | DC to 4 MHz |
| Voltage-axis sensitivity setting | 5 mV/div to 20 V/div (1-2-5 steps) |
| Maximum input voltage (At 1 kHz or less) | (across input terminals H and L* ²) 250 V(DC+ACpeak)(CAT I and II, 177 Vrms) |
| DC offset range (max) (At 1:1 probe attenuation) | 5 mV/div to 50 mV/div : ± 0.5 V 100 mV/div to 500 mV/div : ± 5 V 1 V/div to 5 V/div : ± 50 V 10 V/div to 20 V/div : ± 250 V* ³ |
| Vertical (voltage) axis accuracy DC accuracy* ¹ | 20 mV/div to 20 V/div : $\pm (1.2\% \text{ of } 8 \text{ div} + \text{offset voltage accuracy})$ 5 mV/div to 10 V/div : $\pm (1.5\% \text{ of } 8 \text{ div} + \text{offset voltage accuracy})$ |
| offset axis accuracy* ¹ | $\pm (0.04\% \text{ of offset voltage range} + 1\% \text{ of setting value})$ |
| Input connector | BNC connector |
| Input impedance | 1 M Ω 1%, approx. 30pF |
| -3dB point for AC coupling used | 10 Hz or less(1 Hz or less when using 10:1 probe) |
| Residual noise* ⁴ | Larger of $\pm 300 \mu\text{V}$ or ± 0.04 div(typical* ⁴) |
| A/D conversion resolution | 12 bit (500 LSB/div) |
| Probe attenuation settings | 1:1, 10:1, 100:1 and 1000:1 |
| Bandwidth limit | Select from OFF/500 Hz/5 kHz/50 kHz/500 kHz |

*1 Measured value under standard operating conditions (refer to page 15-6)

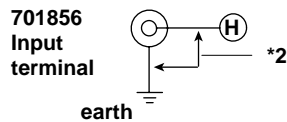

*3 Cannot exceed maximum input voltage

*4 Measured under the following conditions: input block shorted

*5 Typical (or average) value; not guaranteed

15.18 High-Resolution, High-Voltage, Isolation Module (701852)

| Item | Specifications | | | | | | | | | | | | | | | | | | | | | | | | | | | | | | | | | | | | | | | | | | |
|---|---|-----------------|----------------------|-----------------|----------|--------|-----|---------|--------|-----|---------|-------|-----|---------|-------|-------|--------|-------|-------|--------|--------|-------|--------|--------|--------|---------|--------|--------|---------|-------|--------|---------|-------|-------|--------|-------|-------|-------------|-------|-------|---------------|-------|-------|
| Number of input channels | 1 | | | | | | | | | | | | | | | | | | | | | | | | | | | | | | | | | | | | | | | | | | |
| Input coupling settings | AC, DC, GND | | | | | | | | | | | | | | | | | | | | | | | | | | | | | | | | | | | | | | | | | | |
| Maximum sample rate | 100 kS/s | | | | | | | | | | | | | | | | | | | | | | | | | | | | | | | | | | | | | | | | | | |
| Input format | Isolated unbalanced | | | | | | | | | | | | | | | | | | | | | | | | | | | | | | | | | | | | | | | | | | |
| Frequency characteristics* ¹ (-3 dB point when sine wave of amplitude ± 3 div is input) | 100 mV/div to 200 V/div : DC to 40 kHz 5 mV : DC to 30 kHz | | | | | | | | | | | | | | | | | | | | | | | | | | | | | | | | | | | | | | | | | | |
| Voltage-axis sensitivity setting | 50 mV/div to 200 V/div (1-2-5 steps) | | | | | | | | | | | | | | | | | | | | | | | | | | | | | | | | | | | | | | | | | | |
| Maximum input voltage (At 1 kHz or less) | (across input terminals H and L* ²) 850 V(DC+ACpeak)(CAT I and II, 600 Vrms) | | | | | | | | | | | | | | | | | | | | | | | | | | | | | | | | | | | | | | | | | | |
| Maximum allowable common mode voltage | (across input terminal H or L and earth* ³) 400 Vrms (CAT I and II) (Specification when the EN61010-1 standard does not need to be satisfied: 600 Vrms) | | | | | | | | | | | | | | | | | | | | | | | | | | | | | | | | | | | | | | | | | | |
| Vertical (voltage) axis accuracy DC accuracy* ¹ * ⁴ (bandwidth limit Auto excluded) | 100 mV/div to 200 V/div : $\pm (0.5\%$ of 8 div) 50 mV/div : $\pm (1\%$ of 8 div) | | | | | | | | | | | | | | | | | | | | | | | | | | | | | | | | | | | | | | | | | | |
| Input connector | Safety terminal type (for banana plug) | | | | | | | | | | | | | | | | | | | | | | | | | | | | | | | | | | | | | | | | | | |
| Input impedance | 1 M Ω \pm 1% | | | | | | | | | | | | | | | | | | | | | | | | | | | | | | | | | | | | | | | | | | |
| -3dB point for AC coupling used | 1 Hz or less | | | | | | | | | | | | | | | | | | | | | | | | | | | | | | | | | | | | | | | | | | |
| Common mode rejection ratio | 80 dB(50/60 Hz) or more (typical* ⁶) | | | | | | | | | | | | | | | | | | | | | | | | | | | | | | | | | | | | | | | | | | |
| Residual noise* ⁵ | Larger of ± 2.5 mV or ± 0.01 div (typical* ⁶) | | | | | | | | | | | | | | | | | | | | | | | | | | | | | | | | | | | | | | | | | | |
| Withstand voltage (across input terminal and earth) | 3700 VAC for 1 minute (60 Hz) | | | | | | | | | | | | | | | | | | | | | | | | | | | | | | | | | | | | | | | | | | |
| Isolation resistance (across input terminal and earth) | 10 M Ω or more (500 VDC) | | | | | | | | | | | | | | | | | | | | | | | | | | | | | | | | | | | | | | | | | | |
| A/D conversion resolution | 16 bit (8000 LSB/div) | | | | | | | | | | | | | | | | | | | | | | | | | | | | | | | | | | | | | | | | | | |
| Temperature coefficient Zero point Gain | $\pm (0.02\%$ of 8 div)/ $^{\circ}$ C (bandwidth limit Auto excluded) $\pm (0.02\%$ of 8 div)/ $^{\circ}$ C (bandwidth limit Auto excluded) | | | | | | | | | | | | | | | | | | | | | | | | | | | | | | | | | | | | | | | | | | |
| Bandwidth limit | Select from OFF/Auto/40 Hz/400 Hz/4 kHz | | | | | | | | | | | | | | | | | | | | | | | | | | | | | | | | | | | | | | | | | | |
| Anti-aliasing filter | When the bandwidth limit is Auto, the following anti-aliasing filter and low pass filter are set according to the sample rate. | | | | | | | | | | | | | | | | | | | | | | | | | | | | | | | | | | | | | | | | | | |
| | <table border="1"> <thead> <tr> <th>sample rate</th> <th>anti-aliasing filter</th> <th>low pass filter</th> </tr> </thead> <tbody> <tr> <td>100 kS/s</td> <td>40 kHz</td> <td>OFF</td> </tr> <tr> <td>50 kS/s</td> <td>20 kHz</td> <td>OFF</td> </tr> <tr> <td>20 kS/s</td> <td>8 kHz</td> <td>OFF</td> </tr> <tr> <td>10 kS/s</td> <td>4 kHz</td> <td>4 kHz</td> </tr> <tr> <td>5 kS/s</td> <td>2 kHz</td> <td>4 kHz</td> </tr> <tr> <td>2 kS/s</td> <td>800 Hz</td> <td>4 kHz</td> </tr> <tr> <td>1 kS/s</td> <td>400 Hz</td> <td>400 Hz</td> </tr> <tr> <td>500 S/s</td> <td>200 Hz</td> <td>400 Hz</td> </tr> <tr> <td>200 S/s</td> <td>80 Hz</td> <td>400 Hz</td> </tr> <tr> <td>100 S/s</td> <td>40 Hz</td> <td>40 Hz</td> </tr> <tr> <td>50 S/s</td> <td>20 Hz</td> <td>40 Hz</td> </tr> <tr> <td>20 to 5 S/s</td> <td>20 Hz</td> <td>40 Hz</td> </tr> <tr> <td>2 S/s or less</td> <td>20 Hz</td> <td>40 Hz</td> </tr> </tbody> </table> | sample rate | anti-aliasing filter | low pass filter | 100 kS/s | 40 kHz | OFF | 50 kS/s | 20 kHz | OFF | 20 kS/s | 8 kHz | OFF | 10 kS/s | 4 kHz | 4 kHz | 5 kS/s | 2 kHz | 4 kHz | 2 kS/s | 800 Hz | 4 kHz | 1 kS/s | 400 Hz | 400 Hz | 500 S/s | 200 Hz | 400 Hz | 200 S/s | 80 Hz | 400 Hz | 100 S/s | 40 Hz | 40 Hz | 50 S/s | 20 Hz | 40 Hz | 20 to 5 S/s | 20 Hz | 40 Hz | 2 S/s or less | 20 Hz | 40 Hz |
| sample rate | anti-aliasing filter | low pass filter | | | | | | | | | | | | | | | | | | | | | | | | | | | | | | | | | | | | | | | | | |
| 100 kS/s | 40 kHz | OFF | | | | | | | | | | | | | | | | | | | | | | | | | | | | | | | | | | | | | | | | | |
| 50 kS/s | 20 kHz | OFF | | | | | | | | | | | | | | | | | | | | | | | | | | | | | | | | | | | | | | | | | |
| 20 kS/s | 8 kHz | OFF | | | | | | | | | | | | | | | | | | | | | | | | | | | | | | | | | | | | | | | | | |
| 10 kS/s | 4 kHz | 4 kHz | | | | | | | | | | | | | | | | | | | | | | | | | | | | | | | | | | | | | | | | | |
| 5 kS/s | 2 kHz | 4 kHz | | | | | | | | | | | | | | | | | | | | | | | | | | | | | | | | | | | | | | | | | |
| 2 kS/s | 800 Hz | 4 kHz | | | | | | | | | | | | | | | | | | | | | | | | | | | | | | | | | | | | | | | | | |
| 1 kS/s | 400 Hz | 400 Hz | | | | | | | | | | | | | | | | | | | | | | | | | | | | | | | | | | | | | | | | | |
| 500 S/s | 200 Hz | 400 Hz | | | | | | | | | | | | | | | | | | | | | | | | | | | | | | | | | | | | | | | | | |
| 200 S/s | 80 Hz | 400 Hz | | | | | | | | | | | | | | | | | | | | | | | | | | | | | | | | | | | | | | | | | |
| 100 S/s | 40 Hz | 40 Hz | | | | | | | | | | | | | | | | | | | | | | | | | | | | | | | | | | | | | | | | | |
| 50 S/s | 20 Hz | 40 Hz | | | | | | | | | | | | | | | | | | | | | | | | | | | | | | | | | | | | | | | | | |
| 20 to 5 S/s | 20 Hz | 40 Hz | | | | | | | | | | | | | | | | | | | | | | | | | | | | | | | | | | | | | | | | | |
| 2 S/s or less | 20 Hz | 40 Hz | | | | | | | | | | | | | | | | | | | | | | | | | | | | | | | | | | | | | | | | | |
| | * Cut-off characteristic : -72 dB/1.5fc | | | | | | | | | | | | | | | | | | | | | | | | | | | | | | | | | | | | | | | | | | |

*1 Measured value under standard operating conditions (refer to page 15-6)

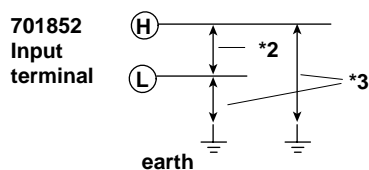

*4 When set to position center

*5 Measured under the following conditions: input block shorted

*6 Typical (or average) value; not guaranteed

15.19 High-Resolution, Isolation Module (701853)

| Item | Specifications | | | | | | | | | | | | | | | | | | | | | | | | | | | | | | | | | | | | | | | | | | |
|--|---|-----------------|----------------------|-----------------|----------|--------|-----|---------|--------|-----|---------|-------|-----|---------|-------|-------|--------|-------|-------|--------|--------|-------|--------|--------|--------|---------|--------|--------|---------|-------|--------|---------|-------|-------|--------|-------|-------|-------------|-------|-------|---------------|-------|-------|
| Number of input channels | 1 | | | | | | | | | | | | | | | | | | | | | | | | | | | | | | | | | | | | | | | | | | |
| Input coupling settings | AC, DC, GND | | | | | | | | | | | | | | | | | | | | | | | | | | | | | | | | | | | | | | | | | | |
| Maximum sample rate | 100 kS/s | | | | | | | | | | | | | | | | | | | | | | | | | | | | | | | | | | | | | | | | | | |
| Input format | Isolated unbalanced | | | | | | | | | | | | | | | | | | | | | | | | | | | | | | | | | | | | | | | | | | |
| Frequency characteristics* ¹ (-3 dB point when sine wave of amplitude ± 3 div is input) | 10 mV/div to 20 V/div : DC to 40 kHz 5 mV/div : DC to 30 kHz | | | | | | | | | | | | | | | | | | | | | | | | | | | | | | | | | | | | | | | | | | |
| Voltage-axis sensitivity setting | 5 mV/div to 20 V/div (1-2-5 steps) | | | | | | | | | | | | | | | | | | | | | | | | | | | | | | | | | | | | | | | | | | |
| Maximum input voltage (At 1 kHz or less) | (across input terminals H and L* ²) 100 V(DC+ACpeak)(CAT I and II, 69 Vrms) | | | | | | | | | | | | | | | | | | | | | | | | | | | | | | | | | | | | | | | | | | |
| Maximum allowable common mode voltage | (across input terminal H or L and earth* ³) 400 Vrms (CAT I and II) (Specification when the EN61010-1 standard does not need to be satisfied: 600 Vrms) | | | | | | | | | | | | | | | | | | | | | | | | | | | | | | | | | | | | | | | | | | |
| Vertical (voltage) axis accuracy DC accuracy* ^{1*4} (bandwidth limit Auto excluded) | 5 mV/div : \pm (1% of 8 div) 10 mV/div : \pm (0.5% of 8 div) 20 mV/div to 20 V/div : \pm (0.3% of 8 div) | | | | | | | | | | | | | | | | | | | | | | | | | | | | | | | | | | | | | | | | | | |
| Input connector | Safety binding post | | | | | | | | | | | | | | | | | | | | | | | | | | | | | | | | | | | | | | | | | | |
| Input impedance | 1 M Ω \pm 1% | | | | | | | | | | | | | | | | | | | | | | | | | | | | | | | | | | | | | | | | | | |
| -3dB point for AC coupling used | 1 Hz or less | | | | | | | | | | | | | | | | | | | | | | | | | | | | | | | | | | | | | | | | | | |
| Common mode rejection ratio | 80dB(50/60 Hz) or more (typical* ⁶) | | | | | | | | | | | | | | | | | | | | | | | | | | | | | | | | | | | | | | | | | | |
| Residual noise* ⁵ | Larger of ± 50 μ V or ± 0.01 div (typical* ⁶) | | | | | | | | | | | | | | | | | | | | | | | | | | | | | | | | | | | | | | | | | | |
| Withstand voltage (across input terminal and earth) | 3700 VAC for 1 minute (60 Hz) | | | | | | | | | | | | | | | | | | | | | | | | | | | | | | | | | | | | | | | | | | |
| Isolation resistance (across input terminal and earth) | 10 M Ω or more (500 VDC) | | | | | | | | | | | | | | | | | | | | | | | | | | | | | | | | | | | | | | | | | | |
| A/D conversion resolution | 16 bit (8000 LSB/div) | | | | | | | | | | | | | | | | | | | | | | | | | | | | | | | | | | | | | | | | | | |
| Temperature coefficient Zero point Gain | \pm (0.02% of 8 div)/ $^{\circ}$ C (bandwidth limit Auto excluded) \pm (0.02% of 8 div)/ $^{\circ}$ C (bandwidth limit Auto excluded) | | | | | | | | | | | | | | | | | | | | | | | | | | | | | | | | | | | | | | | | | | |
| Bandwidth limit | Select from OFF/Auto/40 Hz/400 Hz/4 kHz | | | | | | | | | | | | | | | | | | | | | | | | | | | | | | | | | | | | | | | | | | |
| Anti-aliasing filter | When the bandwidth limit is Auto, the following anti-aliasing filter and low pass filter are set according to the sample rate. | | | | | | | | | | | | | | | | | | | | | | | | | | | | | | | | | | | | | | | | | | |
| | <table border="1"> <thead> <tr> <th>sample rate</th> <th>anti-aliasing filter</th> <th>low pass filter</th> </tr> </thead> <tbody> <tr> <td>100 kS/s</td> <td>40 kHz</td> <td>OFF</td> </tr> <tr> <td>50 kS/s</td> <td>20 kHz</td> <td>OFF</td> </tr> <tr> <td>20 kS/s</td> <td>8 kHz</td> <td>OFF</td> </tr> <tr> <td>10 kS/s</td> <td>4 kHz</td> <td>4 kHz</td> </tr> <tr> <td>5 kS/s</td> <td>2 kHz</td> <td>4 kHz</td> </tr> <tr> <td>2 kS/s</td> <td>800 Hz</td> <td>4 kHz</td> </tr> <tr> <td>1 kS/s</td> <td>400 Hz</td> <td>400 Hz</td> </tr> <tr> <td>500 S/s</td> <td>200 Hz</td> <td>400 Hz</td> </tr> <tr> <td>200 S/s</td> <td>80 Hz</td> <td>400 Hz</td> </tr> <tr> <td>100 S/s</td> <td>40 Hz</td> <td>40 Hz</td> </tr> <tr> <td>50 S/s</td> <td>20 Hz</td> <td>40 Hz</td> </tr> <tr> <td>20 to 5 S/s</td> <td>20 Hz</td> <td>40 Hz</td> </tr> <tr> <td>2 S/s or less</td> <td>20 Hz</td> <td>40 Hz</td> </tr> </tbody> </table> | sample rate | anti-aliasing filter | low pass filter | 100 kS/s | 40 kHz | OFF | 50 kS/s | 20 kHz | OFF | 20 kS/s | 8 kHz | OFF | 10 kS/s | 4 kHz | 4 kHz | 5 kS/s | 2 kHz | 4 kHz | 2 kS/s | 800 Hz | 4 kHz | 1 kS/s | 400 Hz | 400 Hz | 500 S/s | 200 Hz | 400 Hz | 200 S/s | 80 Hz | 400 Hz | 100 S/s | 40 Hz | 40 Hz | 50 S/s | 20 Hz | 40 Hz | 20 to 5 S/s | 20 Hz | 40 Hz | 2 S/s or less | 20 Hz | 40 Hz |
| sample rate | anti-aliasing filter | low pass filter | | | | | | | | | | | | | | | | | | | | | | | | | | | | | | | | | | | | | | | | | |
| 100 kS/s | 40 kHz | OFF | | | | | | | | | | | | | | | | | | | | | | | | | | | | | | | | | | | | | | | | | |
| 50 kS/s | 20 kHz | OFF | | | | | | | | | | | | | | | | | | | | | | | | | | | | | | | | | | | | | | | | | |
| 20 kS/s | 8 kHz | OFF | | | | | | | | | | | | | | | | | | | | | | | | | | | | | | | | | | | | | | | | | |
| 10 kS/s | 4 kHz | 4 kHz | | | | | | | | | | | | | | | | | | | | | | | | | | | | | | | | | | | | | | | | | |
| 5 kS/s | 2 kHz | 4 kHz | | | | | | | | | | | | | | | | | | | | | | | | | | | | | | | | | | | | | | | | | |
| 2 kS/s | 800 Hz | 4 kHz | | | | | | | | | | | | | | | | | | | | | | | | | | | | | | | | | | | | | | | | | |
| 1 kS/s | 400 Hz | 400 Hz | | | | | | | | | | | | | | | | | | | | | | | | | | | | | | | | | | | | | | | | | |
| 500 S/s | 200 Hz | 400 Hz | | | | | | | | | | | | | | | | | | | | | | | | | | | | | | | | | | | | | | | | | |
| 200 S/s | 80 Hz | 400 Hz | | | | | | | | | | | | | | | | | | | | | | | | | | | | | | | | | | | | | | | | | |
| 100 S/s | 40 Hz | 40 Hz | | | | | | | | | | | | | | | | | | | | | | | | | | | | | | | | | | | | | | | | | |
| 50 S/s | 20 Hz | 40 Hz | | | | | | | | | | | | | | | | | | | | | | | | | | | | | | | | | | | | | | | | | |
| 20 to 5 S/s | 20 Hz | 40 Hz | | | | | | | | | | | | | | | | | | | | | | | | | | | | | | | | | | | | | | | | | |
| 2 S/s or less | 20 Hz | 40 Hz | | | | | | | | | | | | | | | | | | | | | | | | | | | | | | | | | | | | | | | | | |
| | * Cut-off characteristic : -72 dB/1.5fc | | | | | | | | | | | | | | | | | | | | | | | | | | | | | | | | | | | | | | | | | | |

*1 Measured value under standard operating conditions (refer to page 15-6)

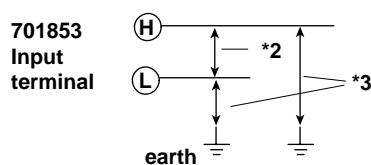

*4 When set to position center

*5 Measured under the following conditions: input block shorted

*6 Typical (or average) value; not guaranteed

15.20 Temperature Module (701860)

| Item | Specifications | | | | | | | | | | | | | | | | | | | | | | | | | | | | | | | | | | | | | | | |
|--|---|--|-------------------|----------|---|-----------------|-----------------------------|---|----------------|--|---|-----------------|--|---|----------------|--|---|----------------|--|---|----------------|--|---|--------------|--|---|--------------|----------------------------|---|--------------|--|---|----------------|---|---|--------------|---------------------------|-----------|------------|--|
| Number of input channels | 1 | | | | | | | | | | | | | | | | | | | | | | | | | | | | | | | | | | | | | | | |
| Data update rate | Approx. 135 Hz | | | | | | | | | | | | | | | | | | | | | | | | | | | | | | | | | | | | | | | |
| Input format | Isolated unbalanced | | | | | | | | | | | | | | | | | | | | | | | | | | | | | | | | | | | | | | | |
| Sensor | Thermocouple | | | | | | | | | | | | | | | | | | | | | | | | | | | | | | | | | | | | | | | |
| Measurement range/accuracy*1*2 | <table border="1"> <thead> <tr> <th>Type</th> <th>Measurement range</th> <th>Accuracy</th> </tr> </thead> <tbody> <tr> <td>K</td> <td>-200 to 1300 °C</td> <td>± (0.2% of reading + 1.5°C)</td> </tr> <tr> <td>E</td> <td>-200 to 800 °C</td> <td>except -200°C to 0°C : ± (0.5% of reading ± 1.5°C)</td> </tr> <tr> <td>J</td> <td>-200 to 1100 °C</td> <td></td> </tr> <tr> <td>T</td> <td>-200 to 400 °C</td> <td></td> </tr> <tr> <td>L</td> <td>-200 to 900 °C</td> <td></td> </tr> <tr> <td>U</td> <td>-200 to 400 °C</td> <td></td> </tr> <tr> <td>N</td> <td>0 to 1300 °C</td> <td></td> </tr> <tr> <td>R</td> <td>0 to 1700 °C</td> <td>± (0.2% of reading + 3 °C)</td> </tr> <tr> <td>S</td> <td>0 to 1700 °C</td> <td>except ± 8°C for 0 to 200°C and ± 5 °C for 200 to 800 °C</td> </tr> <tr> <td>B</td> <td>400 to 1800 °C</td> <td>±(0.2% of reading + 4°C) except ± 8°C for 400 to 700 °C</td> </tr> <tr> <td>W</td> <td>0 to 2300 °C</td> <td>±(0.2% of reading + 3 °C)</td> </tr> <tr> <td>KPvsAu7Fe</td> <td>0 to 300 K</td> <td>0 to 50 K : ± 8.0 K 50 to 300 K : ± 4.5 K</td> </tr> </tbody> </table> | Type | Measurement range | Accuracy | K | -200 to 1300 °C | ± (0.2% of reading + 1.5°C) | E | -200 to 800 °C | except -200°C to 0°C : ± (0.5% of reading ± 1.5°C) | J | -200 to 1100 °C | | T | -200 to 400 °C | | L | -200 to 900 °C | | U | -200 to 400 °C | | N | 0 to 1300 °C | | R | 0 to 1700 °C | ± (0.2% of reading + 3 °C) | S | 0 to 1700 °C | except ± 8°C for 0 to 200°C and ± 5 °C for 200 to 800 °C | B | 400 to 1800 °C | ±(0.2% of reading + 4°C) except ± 8°C for 400 to 700 °C | W | 0 to 2300 °C | ±(0.2% of reading + 3 °C) | KPvsAu7Fe | 0 to 300 K | 0 to 50 K : ± 8.0 K 50 to 300 K : ± 4.5 K |
| Type | Measurement range | Accuracy | | | | | | | | | | | | | | | | | | | | | | | | | | | | | | | | | | | | | | |
| K | -200 to 1300 °C | ± (0.2% of reading + 1.5°C) | | | | | | | | | | | | | | | | | | | | | | | | | | | | | | | | | | | | | | |
| E | -200 to 800 °C | except -200°C to 0°C : ± (0.5% of reading ± 1.5°C) | | | | | | | | | | | | | | | | | | | | | | | | | | | | | | | | | | | | | | |
| J | -200 to 1100 °C | | | | | | | | | | | | | | | | | | | | | | | | | | | | | | | | | | | | | | | |
| T | -200 to 400 °C | | | | | | | | | | | | | | | | | | | | | | | | | | | | | | | | | | | | | | | |
| L | -200 to 900 °C | | | | | | | | | | | | | | | | | | | | | | | | | | | | | | | | | | | | | | | |
| U | -200 to 400 °C | | | | | | | | | | | | | | | | | | | | | | | | | | | | | | | | | | | | | | | |
| N | 0 to 1300 °C | | | | | | | | | | | | | | | | | | | | | | | | | | | | | | | | | | | | | | | |
| R | 0 to 1700 °C | ± (0.2% of reading + 3 °C) | | | | | | | | | | | | | | | | | | | | | | | | | | | | | | | | | | | | | | |
| S | 0 to 1700 °C | except ± 8°C for 0 to 200°C and ± 5 °C for 200 to 800 °C | | | | | | | | | | | | | | | | | | | | | | | | | | | | | | | | | | | | | | |
| B | 400 to 1800 °C | ±(0.2% of reading + 4°C) except ± 8°C for 400 to 700 °C | | | | | | | | | | | | | | | | | | | | | | | | | | | | | | | | | | | | | | |
| W | 0 to 2300 °C | ±(0.2% of reading + 3 °C) | | | | | | | | | | | | | | | | | | | | | | | | | | | | | | | | | | | | | | |
| KPvsAu7Fe | 0 to 300 K | 0 to 50 K : ± 8.0 K 50 to 300 K : ± 4.5 K | | | | | | | | | | | | | | | | | | | | | | | | | | | | | | | | | | | | | | |
| Maximum input voltage (At 1 kHz or less) | (across input terminals H and L*3) 42 V(DC+ACpeak)(CAT I and II, 30 Vrms) | | | | | | | | | | | | | | | | | | | | | | | | | | | | | | | | | | | | | | | |
| Maximum allowable common mode voltage (At 1 kHz or less) | (across input terminal H or L and earth*4) 42 V(DC+ACpeak)(CAT I and II, 30 Vrms) | | | | | | | | | | | | | | | | | | | | | | | | | | | | | | | | | | | | | | | |
| Input connector | Binding post | | | | | | | | | | | | | | | | | | | | | | | | | | | | | | | | | | | | | | | |
| Input impedance | 1 MΩ | | | | | | | | | | | | | | | | | | | | | | | | | | | | | | | | | | | | | | | |
| Common mode rejection ratio | 80 dB(50/60 Hz, signal source resistance 500 Ω or less) 120 dB(50/60 Hz, 2 Hz filter ON, signal source resistance 500 Ω or less) | | | | | | | | | | | | | | | | | | | | | | | | | | | | | | | | | | | | | | | |
| Vertical resolution | During waveform display and cursor measurements : 0.1°C During automatic measurement of waveform parameters : 0.4°C | | | | | | | | | | | | | | | | | | | | | | | | | | | | | | | | | | | | | | | |
| Temperature coefficient | ± (0.02 % of FS)/ °C | | | | | | | | | | | | | | | | | | | | | | | | | | | | | | | | | | | | | | | |
| Reference junction compensation accuracy (when input terminal temperature is balanced) | ± 1°C(K, E, J, T, L, U, N) ±1.5 °C(R, S, B, W) ±1 K(KPvsAu7Fe) | | | | | | | | | | | | | | | | | | | | | | | | | | | | | | | | | | | | | | | |
| Bandwidth limit | Select from OFF/2 Hz/8 Hz | | | | | | | | | | | | | | | | | | | | | | | | | | | | | | | | | | | | | | | |

*1 Under standard operating conditions (refer to page 15-6)

*2 Reference junction temperature compensation accuracy not included

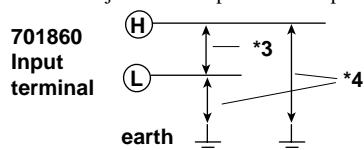

15.21 Logic Input Module (701870)

| Item | Specifications |
|------------------------|---|
| Number of input points | 16 (8 bits X 2) |
| Maximum sample rate | 10 MS/s, except the response rate depends on the response time of the logic probe |

* Only dedicated logic probes can be used.

High-Speed Logic Probe (700986) Specifications

| Item | Specifications |
|--|---|
| Number of input points | 8 |
| Input format | Non-isolated (the earth of each bit are common, the earth of the logic module and the earth of each bit are common) |
| Maximum input voltage (at a frequency of 1 kHz or less) | 42 V (DC+ACpeak)(CAT I and CAT II, 30 Vrms), across probe tip and earth |
| Response time | 1 μ s or less |
| Input impedance | 100 k Ω or more |
| Threshold level | approx. 1.4 V |

Isolation Logic Probe (700987) Specifications

| Item | Specifications |
|---|--|
| Number of input points | 8 |
| Input format | Isolated (all bits are isolated) |
| Input connector | Safety terminal type (for banana plug) X 8 |
| Input switching | Can switch between AC/DC input for each bit |
| Input signal display | Can confirm H/L with the LED for each bit (lights when H) |
| Applicable input range | During DC input: H/L detection of 10 VDC to 250 VDC During AC input: H/L detection of AC type of 80 VAC to 250 VAC 50/60 Hz |
| Threshold level | During DC input: 6 VDC \pm 50% (Hi level: 10 to 250 VDC, Lo level: 0 to 3 VDC) During AC input: 50 VAC \pm 50% (Hi level: 80 to 250 VDC, Lo level: 0 to 20 VAC) |
| Response time | During DC input: within 1 ms During AC input: within 20 ms |
| Input impedance | approx. 100 k Ω |
| Maximum input voltage (across H and L of each bit) | 250 Vrms* ¹ (CAT I and II) |
| Maximum allowable common mode voltage (across input terminal H or L and earth) | 250 Vrms* ¹ (CAT I and II) |
| Maximum allowable voltage between bits | 250 Vrms* ¹ (CAT I and II) |
| Withstand voltage (across input terminal and earth) | 2000 VAC for 1 minute |
| Isolation resistance (across input terminal and earth) | 500 VDC, 10 M Ω or more |
| Fuse* ² | |

| location | max. rated voltage | max. rated current | type | standard |
|--------------------------|--------------------|--------------------|----------|-----------|
| H side of input terminal | 250 V | 50 mA | time lag | VDE/SEMKO |

*1 Make sure the ACpeak voltage does not exceed 350 V and the DC voltage does not exceed 250 V when the frequency is 1 kHz or less.

*2 Because the fuses used by this instrument are all inside the case, they cannot be exchanged by the user. If you believe the fuse inside the case is blown, please contact your nearest YOKOGAWA dealer listed on the back cover of this manual.

15.22 Strain Module (701880)

| Item | Specifications | | | | | | | | | | | | | | | | | | |
|---|--|--|------------------------|----------|------------------------------|----------------------------------|--|------------------------------|----------------------------------|--|------------------------------|----------------------------------|--|-------------------------------|-----------------------------------|--|-------------------------------|-----------------------------------|--|
| Number of channels | 1 | | | | | | | | | | | | | | | | | | |
| Maximum sample rate | 100 kS/s | | | | | | | | | | | | | | | | | | |
| Input method | DC bridge input method (Auto balancing method), Balanced differential input method, DC amplifier (floating) | | | | | | | | | | | | | | | | | | |
| Auto balancing method | Electronic auto balance | | | | | | | | | | | | | | | | | | |
| Auto balance range | $\pm 10000 \times 10^{-6}$ strain | | | | | | | | | | | | | | | | | | |
| Bridge voltage | Selectable 2V/5V | | | | | | | | | | | | | | | | | | |
| Bridge resistance | Need to externally connect a strain gauge bridge or strain gauge transducer with a cable. Recommended bridge head: 700932 (bridge resistance of 120 Ω) or 700933 (bridge resistance of 350 Ω) | | | | | | | | | | | | | | | | | | |
| Applicable bridge resistance | 120 to 1000 Ω (at bridge voltage 2 V), 350 to 1000 Ω (at bridge voltage 5 V) | | | | | | | | | | | | | | | | | | |
| Gauge factor | 1.90 to 2.20 (in 0.01 steps) | | | | | | | | | | | | | | | | | | |
| Frequency characteristics* ¹ (-3 dB point when sine wave of amplitude ± 3 div is input) | DC to 20 kHz | | | | | | | | | | | | | | | | | | |
| Measurement range/accuracy* ^{1*2} | <table border="1"> <thead> <tr> <th>Range</th> <th>Measurement range (FS)</th> <th>Accuracy</th> </tr> </thead> <tbody> <tr> <td>1000×10^{-6} strain</td> <td>$\pm 1000 \times 10^{-6}$ strain</td> <td>$\pm 1\%$ of FS $\pm 40 \times 10^{-6}$ strain</td> </tr> <tr> <td>2000×10^{-6} strain</td> <td>$\pm 2000 \times 10^{-6}$ strain</td> <td>$\pm 1\%$ of FS $\pm 40 \times 10^{-6}$ strain</td> </tr> <tr> <td>5000×10^{-6} strain</td> <td>$\pm 5000 \times 10^{-6}$ strain</td> <td>$\pm 1\%$ of FS $\pm 40 \times 10^{-6}$ strain</td> </tr> <tr> <td>10000×10^{-6} strain</td> <td>$\pm 10000 \times 10^{-6}$ strain</td> <td>$\pm 1\%$ of FS $\pm 40 \times 10^{-6}$ strain</td> </tr> <tr> <td>20000×10^{-6} strain</td> <td>$\pm 20000 \times 10^{-6}$ strain</td> <td>$\pm 1\%$ of FS $\pm 40 \times 10^{-6}$ strain</td> </tr> </tbody> </table> | Range | Measurement range (FS) | Accuracy | 1000×10^{-6} strain | $\pm 1000 \times 10^{-6}$ strain | $\pm 1\%$ of FS $\pm 40 \times 10^{-6}$ strain | 2000×10^{-6} strain | $\pm 2000 \times 10^{-6}$ strain | $\pm 1\%$ of FS $\pm 40 \times 10^{-6}$ strain | 5000×10^{-6} strain | $\pm 5000 \times 10^{-6}$ strain | $\pm 1\%$ of FS $\pm 40 \times 10^{-6}$ strain | 10000×10^{-6} strain | $\pm 10000 \times 10^{-6}$ strain | $\pm 1\%$ of FS $\pm 40 \times 10^{-6}$ strain | 20000×10^{-6} strain | $\pm 20000 \times 10^{-6}$ strain | $\pm 1\%$ of FS $\pm 40 \times 10^{-6}$ strain |
| Range | Measurement range (FS) | Accuracy | | | | | | | | | | | | | | | | | |
| 1000×10^{-6} strain | $\pm 1000 \times 10^{-6}$ strain | $\pm 1\%$ of FS $\pm 40 \times 10^{-6}$ strain | | | | | | | | | | | | | | | | | |
| 2000×10^{-6} strain | $\pm 2000 \times 10^{-6}$ strain | $\pm 1\%$ of FS $\pm 40 \times 10^{-6}$ strain | | | | | | | | | | | | | | | | | |
| 5000×10^{-6} strain | $\pm 5000 \times 10^{-6}$ strain | $\pm 1\%$ of FS $\pm 40 \times 10^{-6}$ strain | | | | | | | | | | | | | | | | | |
| 10000×10^{-6} strain | $\pm 10000 \times 10^{-6}$ strain | $\pm 1\%$ of FS $\pm 40 \times 10^{-6}$ strain | | | | | | | | | | | | | | | | | |
| 20000×10^{-6} strain | $\pm 20000 \times 10^{-6}$ strain | $\pm 1\%$ of FS $\pm 40 \times 10^{-6}$ strain | | | | | | | | | | | | | | | | | |
| Maximum input voltage | (across terminals) 5 V (DC+ACpeak) | | | | | | | | | | | | | | | | | | |
| Maximum allowable common mode voltage | (across each terminal and earth) 42 V (DC+ACpeak) (CAT I and II, 30 Vrms) | | | | | | | | | | | | | | | | | | |
| Input connector | NDIS (A connector recommended by JSNDI (The Japanese Society for Non-destructive Inspection.)) | | | | | | | | | | | | | | | | | | |
| Input resistance | 10 M Ω or more | | | | | | | | | | | | | | | | | | |
| Common mode rejection ratio | 80 dB(50/60Hz) or more, signal source resistance 1 k Ω | | | | | | | | | | | | | | | | | | |
| A/D conversion resolution | 14 bit | | | | | | | | | | | | | | | | | | |
| Temperature coefficient | | | | | | | | | | | | | | | | | | | |
| Zero point | $\pm 5 \times 10^{-6}$ strain/ $^{\circ}$ C (after input conversion and auto calibration) | | | | | | | | | | | | | | | | | | |
| Gain | $\pm (0.05\%$ of FS)/ $^{\circ}$ C (after auto calibration) | | | | | | | | | | | | | | | | | | |
| Bandwidth limit | Select OFF/10 Hz/100 Hz/1 kHz, -12 dB/Oct | | | | | | | | | | | | | | | | | | |

*1 Measured value under standard operating conditions (refer to page 15-6)

*2 Gauge factor 2, accuracy of the strain module only

Pin assignments

- A : Bridge+
- B : Input-(measurement signal-)
- C : Bridge-
- D : Input+(measurement signal+)
- E : Floating common
- F : Sense+
- G : Sense-

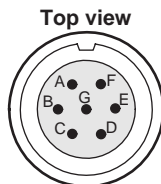

The connector shell is connected to the functional earth.

Appendix 1 Relationship between the Time Axis Setting, Sample Rate and Record Length

| Record length T/div | 1k Word | | 10k Word | | 40k Word | | 100k Word | |
|------------------------|-------------------|--------------------------------|-------------------|--------------------------------|-------------------|--------------------------------|-------------------|--------------------------------|
| | Sample rate (S/s) | Displayed record length (Word) | Sample rate (S/s) | Displayed record length (Word) | Sample rate (S/s) | Displayed record length (Word) | Sample rate (S/s) | Displayed record length (Word) |
| 100ks | – | – | – | – | – | – | – | – |
| 50ks | – | – | – | – | – | – | – | – |
| 20ks | – | – | – | – | – | – | – | – |
| 10ks | – | – | – | – | – | – | 1 | 100k |
| 5ks | – | – | – | – | 1 | 40k | 2 | 100k |
| 2ks | – | – | – | – | 2 | 40k | 5 | 100k |
| 1ks | – | – | 1 | 10k | 5 | 40k | 10 | 100k |
| 500s | – | – | 2 | 10k | 10 | 40k | 20 | 100k |
| 200s | – | – | 5 | 10k | 20 | 40k | 50 | 100k |
| 100s | 1 | 1k | 10 | 10k | 50 | 40k | 100 | 100k |
| 50s | 2 | 1k | 20 | 10k | 100 | 40k | 200 | 100k |
| 20s | 5 | 1k | 50 | 10k | 200 | 40k | 500 | 100k |
| 10s | 10 | 1k | 100 | 10k | 500 | 40k | 1k | 100k |
| 5s | 20 | 1k | 200 | 10k | 1k | 40k | 2k | 100k |
| 2s | 50 | 1k | 500 | 10k | 2k | 40k | 5k | 100k |
| 1s | 100 | 1k | 1k | 10k | 5k | 40k | 10k | 100k |
| 500ms | 200 | 1k | 2k | 10k | 10k | 40k | 20k | 100k |
| 200ms | 500 | 1k | 5k | 10k | 20k | 40k | 50k | 100k |
| 100ms | 1k | 1k | 10k | 10k | 50k | 40k | 100k | 100k |
| 50ms | 2k | 1k | 20k | 10k | 100k | 40k | 200k | 100k |
| 20ms | 5k | 1k | 50k | 10k | 200k | 40k | 500k | 100k |
| 10ms | 10k | 1k | 100k | 10k | 500k | 40k | 1M | 100k |
| 5ms | 20k | 1k | 200k | 10k | 1M | 40k | 2M | 100k |
| 2ms | 50k | 1k | 500k | 10k | 2M | 40k | 5M | 100k |
| 1ms | 100k | 1k | 1M | 10k | 5M | 40k | 10M | 100k |
| 500μs | 200k | 1k | 2M | 10k | 10M | 40k | 10M | 50k |
| 200μs | 500k | 1k | 5M | 10k | 10M | 20k | 10M | 20k |
| 100μs | 1M | 1k | 10M | 10k | 10M | 10k | 10M | 10k |
| 50μs | 2M | 1k | 10M | 5k | 10M | 5k | 10M | 5k |
| 20μs | 5M | 1k | 10M | 2k | 10M | 2k | 10M | 2k |
| 10μs | 10M | 1k | 10M | 1k | 10M | 1k | 10M | 1k |
| 5μs | 10M | 500 | 10M | 500 | 10M | 500 | 10M | 500 |
| 2μs | 10M | 200 | 10M | 200 | 10M | 200 | 10M | 200 |
| 1μs | 10M | 100 | 10M | 100 | 10M | 100 | 10M | 100 |
| 500ns | 10M | 50 | 10M | 50 | 10M | 50 | 10M | 50 |

- For the settings inside the thick frame, the waveform is displayed in roll mode when the trigger mode is set to auto or auto-level.
- When “Log Start” or “Single Start”* of the ACQ key is selected, the waveform is displayed in the roll mode for the settings inside the thick frame regardless of the trigger mode setting.
 - * If the firmware version of the DL708E is 4.00 or later, waveforms are displayed in roll mode when the “Single Start” soft key is pressed.
- If the acquisition mode is set to “Average,” roll mode is disabled even for the settings inside the thick frame.

Appendix 1 Relationship between the Time Axis Setting, Sample Rate and Record Length

| Record length T/div | 200k Word | | 400k Word | | 1M Word or more | |
|------------------------|-------------------|--------------------------------|-------------------|--------------------------------|-------------------|--------------------------------|
| | Sample rate (S/s) | Displayed record length (Word) | Sample rate (S/s) | Displayed record length (Word) | Sample rate (S/s) | Displayed record length (Word) |
| 100ks | – | – | – | – | 1 | 1M |
| 50ks | – | – | 1 | 400k | 2 | 1M |
| 20ks | 1 | 200k | 2 | 400k | 5 | 1M |
| 10ks | 2 | 200k | 5 | 400k | 10 | 1M |
| 5ks | 5 | 200k | 10 | 400k | 20 | 1M |
| 2ks | 10 | 200k | 20 | 400k | 50 | 1M |
| 1ks | 20 | 200k | 50 | 400k | 100 | 1M |
| 500s | 50 | 200k | 100 | 400k | 200 | 1M |
| 200s | 100 | 200k | 200 | 400k | 500 | 1M |
| 100s | 200 | 200k | 500 | 400k | 1k | 1M |
| 50s | 500 | 200k | 1k | 400k | 2k | 1M |
| 20s | 1k | 200k | 2k | 400k | 5k | 1M |
| 10s | 2k | 200k | 5k | 400k | 10k | 1M |
| 5s | 5k | 200k | 10k | 400k | 20k | 1M |
| 2s | 10k | 200k | 20k | 400k | 50k | 1M |
| 1s | 20k | 200k | 50k | 400k | 100k | 1M |
| 500ms | 50k | 200k | 100k | 400k | 200k | 1M |
| 200ms | 100k | 200k | 200k | 400k | 500k | 1M |
| 100ms | 200k | 200k | 500k | 400k | 1M | 1M |
| 50ms | 500k | 200k | 1M | 400k | 2M | 1M |
| 20ms | 1M | 200k | 2M | 400k | 5M | 1M |
| 10ms | 2M | 200k | 5M | 400k | 10M | 1M |
| 5ms | 5M | 200k | 10M | 400k | 10M | 500k |
| 2ms | 10M | 200k | 10M | 200k | 10M | 200k |
| 1ms | 10M | 100k | 10M | 100k | 10M | 100k |
| 500µs | 10M | 50k | 10M | 50k | 10M | 50k |
| 200µs | 10M | 20k | 10M | 20k | 10M | 20k |
| 100µs | 10M | 10k | 10M | 10k | 10M | 10k |
| 50µs | 10M | 5k | 10M | 5k | 10M | 5k |
| 20µs | 10M | 2k | 10M | 2k | 10M | 2k |
| 10µs | 10M | 1k | 10M | 1k | 10M | 1k |
| 5µs | 10M | 500 | 10M | 500 | 10M | 500 |
| 2µs | 10M | 200 | 10M | 200 | 10M | 200 |
| 1µs | 10M | 100 | 10M | 100 | 10M | 100 |
| 500ns | 10M | 50 | 10M | 50 | 10M | 50 |

- For the settings inside the thick frame, the waveform is displayed in roll mode when the trigger mode is set to auto or auto-level.
- When “Log Start” or “Single Start”^{*} of the ACQ key is selected, the waveform is displayed in the roll mode for the settings inside the thick frame regardless of the trigger mode setting.
 - ^{*} If the firmware version of the DL708E is 4.00 or later, waveforms are displayed in roll mode when the “Single Start” soft key is pressed.
- If the acquisition mode is set to “Average,” roll mode is disabled even for the settings inside the thick frame.

Appendix 2 Relationship between the Record Length and Acquisition Mode

The maximum record length that can be selected (upper row: for normal mode, lower row: for averaging mode)

| No. of CH used | Memory Option | | | |
|-----------------|-----------------|--------------|--------------|--------------|
| | None(100 kW/CH) | /M1(1 MW/CH) | /M2(2 MW/CH) | /M3(4 MW/CH) |
| 8CH | 100 k / 10 k | 1 M / 100 k | 2 M / 200 k | 4 M / 400 k |
| 4CH (1,3,5,7CH) | 200 k / 10 k | 2 M / 100 k | 4 M / 200 k | 8 M / 400 k |
| 2CH (1,5CH) | 400 k / 10 k | 4 M / 100 k | 8 M / 200 k | 16 M / 400 k |

Unit:word

The maximum acquisition count of sequential store/history memory

| Count Record length | Memory Option | | | |
|------------------------|-----------------|-------------|-------------|-------------|
| | None (100kW/CH) | /M1(1MW/CH) | /M2(2MW/CH) | /M3(4MW/CH) |
| 1 k | 60 | 512 | 1000 | 1000 |
| 10 k | 10 | 85 | 170 | 341 |
| 40 k | 1* | 21 | 42 | 85 |
| 100 k | 1* | 8 | 17 | 34 |
| 200 k | 1* | 4 | 8 | 17 |
| 400 k | 1* | 1* | 4 | 8 |
| 1 M | – | 1* | 1* | 4 |
| 2 M | – | 1* | 1* | 1* |
| 4 M | – | 1* | 1* | 1* |
| 8 M | – | – | 1* | 1* |
| 16 M | – | – | – | 1* |

* For record length which the acquisition count is one, sequential store cannot be selected.

Appendix 3 How to Calculate the Area of a Waveform

“Integ1TY”

Total area for positive side only: S_1+S_2

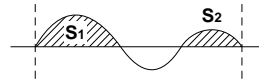

“Integ2TY”

Total area for both positive and negative sides: $S_1+S_3-S_2$

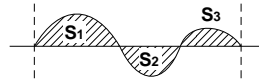

“Integ1XY”

(1) Multiple loops

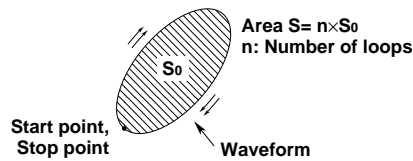

(2) Non-closed curve

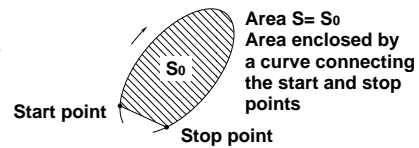

(3) Loop tracing the shape of "8"

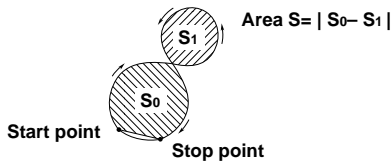

(4) Spiral loop

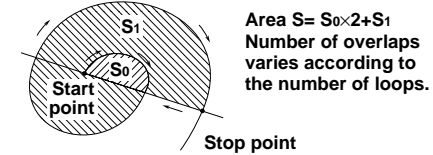

“Integ2XY”

(1) When only one Y data corresponds to X data

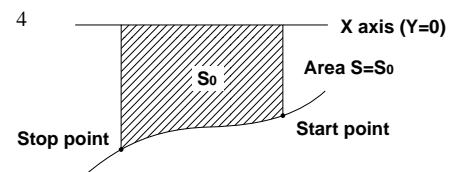
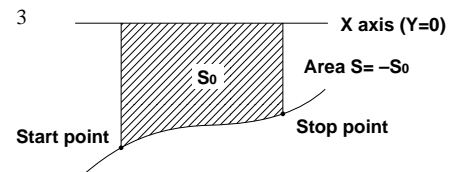
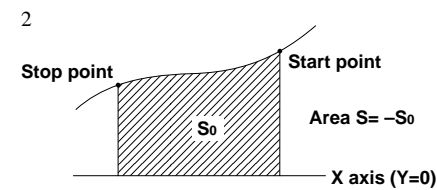
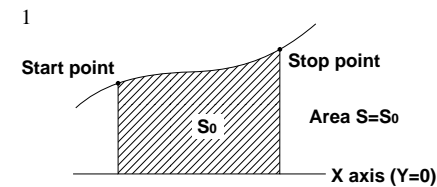

(2) When the waveform extends into the negative side

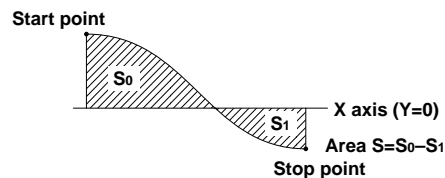

(2) When two or more Y data correspond to X data

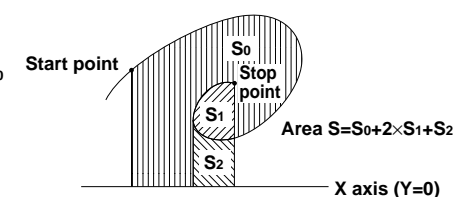
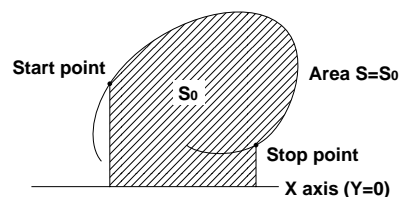

Appendix 4 ASCII Header File Format

//YOKOGAWA ASCII FILE FORMAT

\$PublicInfo

FormatVersion 1.01
Model DL700
Endian Big
DataFormat Block
GroupNumber 3
TraceTotalNumber 10
DataOffset 0

\$Group1

| | | | | |
|----------------|----------------|----------------|----------------|----------------|
| TraceNumber | 4 | | | |
| BlockNumber | 1 | | | |
| TraceName | CH1 | CH2 | CH3 | CH4 |
| BlockSize | 1002 | 1002 | 1002 | 1002 |
| VResolution | 6.2500000E-03 | 6.2500000E-03 | 6.2500000E-03 | 6.2500000E-03 |
| VOffset | 0.0000000E+00 | 0.0000000E+00 | 0.0000000E+00 | 0.0000000E+00 |
| VDataType | IS2 | IS2 | IS2 | IS2 |
| VUnit | V | V | V | V |
| VPlusOverData | 32768 | 32768 | 32768 | 32768 |
| VMinusOverData | -32769 | -32769 | -32769 | -32769 |
| VIllegalData | ? | ? | ? | ? |
| VMaxData | 32767 | 32767 | 32767 | 32767 |
| VMinData | -32768 | -32768 | -32768 | -32768 |
| HResolution | 1.0000000E-07 | 1.0000000E-07 | 1.0000000E-07 | 1.0000000E-07 |
| HOffset | -5.0000000E-05 | -5.0000000E-05 | -5.0000000E-05 | -5.0000000E-05 |
| HUnit | s | s | s | s |
| Date | 97/05/15 | 97/05/15 | 97/05/15 | 97/05/15 |
| Time | 19:12:02 | 19:12:02 | 19:12:02 | 19:12:02 |

\$Group2

| | | | | |
|----------------|----------------|----------------|----------------|----------------|
| TraceNumber | 4 | | | |
| BlockNumber | 1 | | | |
| TraceName | CH5 | CH6 | CH7 | CH8 |
| BlockSize | 1002 | 1002 | 1002 | 1002 |
| VResolution | 6.2500000E-03 | 6.2500000E-03 | 6.2500000E-03 | 6.2500000E-03 |
| VOffset | 0.0000000E+00 | 0.0000000E+00 | 0.0000000E+00 | 0.0000000E+00 |
| VDataType | IS2 | IS2 | IS2 | IS2 |
| VUnit | V | V | V | V |
| VPlusOverData | 32768 | 32768 | 32768 | 32768 |
| VMinusOverData | -32769 | -32769 | -32769 | -32769 |
| VIllegalData | ? | ? | ? | ? |
| VMaxData | 32767 | 32767 | 32767 | 32767 |
| VMinData | -32768 | -32768 | -32768 | -32768 |
| HResolution | 1.0000000E-07 | 1.0000000E-07 | 1.0000000E-07 | 1.0000000E-07 |
| HOffset | -5.0000000E-05 | -5.0000000E-05 | -5.0000000E-05 | -5.0000000E-05 |
| HUnit | s | s | s | s |
| Date | 97/05/15 | 97/05/15 | 97/05/15 | 97/05/15 |
| Time | 19:12:02 | 19:12:02 | 19:12:02 | 19:12:02 |

```

$Group3
TraceNumber      2
BlockNumber      1
TraceName        MATH1          MATH2
BlockSize        1000          1000
VResolution      6.1035156E-05      2.4414063E-04
VOffset          0.0000000E+00    -3.1000004E+00
VDataType        IS2          IS2
VUnit            V            V
VPlusOverData    32768          32768
VMinusOverData   -32769          -32769
VIllegalData     ?            ?
VMaxData         32767          32767
VMinData         -32768          -32768
HResolution      1.0000000E-07      1.0000000E-07
HOffset          -5.0000000E-05      -5.0000000E-05
HUnit            s            s
Date             97/05/15      97/05/15
Time             19:12:02      19:12:02

$PrivateInfo
ModelVersion     1.20
MathBlockNo.     1
FormMath1        C1+C5
FormMath2        C1+C3
DisplayBlockSize 10020    10020    10020    10020    10020    10020    10020    10020
DisplayPointNo.  1         1         1         1         1         1         1         1
PhaseShift       0         0         0         0         0         0         0         0
InputModule      HS        HS        HS        HS        HS        HS        HS        LOGIC    TEMP
    
```

Note

The same header file format is used by all YOKOGAWA measuring instruments, so it may contain some data which are not necessary for the instrument.

• **\$Publicinfo (common information)**

FormatVersion : Version No. of header file format
 Model : Model name
 Endian : Endian mode (Big/Ltl)^{*1}
 DataFormat : Storage format (Trace/Block) of binary file waveform data ^{*2}
 GroupNumber : Number of the \$Group
 TraceTotalNumber : Total number of selected waveforms
 DataOffset : Start position of binary file waveform data ^{*3}

• **\$Group1 (group information)**

TraceNumber : Number of waveforms in the group
 BlockNumber : Number of blocks in the group ^{*4}
 TraceName : Name of each waveform
 BlockSize : Data size of each block of waveform
 VResolution : Resolution coefficient of Y axis conversion equation for each waveform ^{*5}
 VOffset : Offset coefficient of Y axis conversion equation for each waveform
 VDataType : Type of binary file waveform data for each waveform ^{*6}
 VUnit : Units used for Y axis of each waveform (no effect on data)
 VPlusOverData : Data error occurs when binary data for a waveform exceeds this value.
 VMinusOverData : Data error occurs when binary data for a waveform is below this value.
 VMaxData : Maximum value of binary data for each waveform
 VMinData : Minimum value of binary data for each waveform
 HResolution : Resolution coefficient of X axis conversion equation for each waveform ^{*7}
 HOffset : Offset coefficient of X axis conversion equation for each waveform
 HUnit : Units used for X axis for each waveform (no effect on data)
 Date : Date when a trigger is activated
 Time : Time when a trigger is activated

For *1 to *7, refer to the next page.

- **\$Privateinfo (information indigenous to model)**

| | |
|------------------|---|
| ModelVersion | : Version No. of the model |
| MathBlockNo. | : Block No. of block to be computed |
| FormMath1 | : Waveform for Math1 and its contents |
| FormMath2 | : Waveform for Math2 and its contents |
| DisplayBlockSize | : Length of the data displayed on the screen (display record length) |
| DisplayPointNo | : Value which indicates which point of the memory is the left end of the display record length (display offset is 1 when record length = display record length) |
| PhaseShift | : Phase information (lead:-, delay:+) |
| InputModule | : Name of each input module |

Creation of ASCII Header File

When waveform data (Waveform) is stored on a floppy disk, the following files will be created automatically in the DL_WAVE directory.

- Waveform data file (*.WVF)
- ASCII header file (*.HDR)

The waveform data file can be recalled to the instrument using the file menu, but the ASCII header file cannot; therefore it cannot be viewed on the instrument. However, it can be used when you analyze the waveform using a personal computer.

*1: Endian mode for storage

| | |
|-----|----------------------------------|
| Big | : Data for Motorola 68000 series |
| Ltl | : Data for Intel 86 series |

*2: Binary file storage format

| | |
|-------|---|
| Trace | : Groups into blocks, each block for a single waveform. |
| Block | : Groups into blocks, each block for a given time interval. |

*3: Binary file start position

Offset from the beginning of the file

*4: Maximum number of blocks per group

Maximum number of blocks applies if the number of blocks varies between waveforms.

*5: Y axis conversion equation for each waveform

Y axis value = VResolution x Raw data + VOffset

*6: Data type

| | |
|-----|-------------------------------|
| ISn | : n-byte signed integer |
| IUn | : n-byte unsigned integer |
| FSn | : n-byte signed real number |
| FUn | : n-byte unsigned real number |
| Bm | : m-byte data |

*7: X axis conversion equation for each waveform

X axis value = HResolution x (Data No. - 1) + HOffset

Appendix 5 List of Defaults

| Menu key | soft key | Default setting |
|-------------------|---------------------|-----------------|
| CH1 to 8 | | |
| | Display | ON |
| | Position | 0.00 div |
| | Probe | 10:1* |
| | Band Width | Full |
| | Offset | 0 V |
| | Invert | OFF |
| | Define Label | CHCH8 |
| V/div | | |
| | | 50 V* |
| T/div | | |
| | | 10 μs/div |
| Time Base | | |
| | | Int |
| ACQ | | |
| | Record Length | 1 k |
| | Mode | Normal |
| | Count | Infinite |
| TRIGGER | | |
| | SIMPLE | |
| | Mode | Auto |
| | Source | CH1 |
| | Level | 0 V |
| | Slope | ↑ |
| | Hysteresis | AV |
| | Hold Off | 0 μs |
| HISTORY | | |
| | Selected Record No. | 0 |
| | Display | One |
| | Show Map No. | 1 |
| FILE | | |
| | Function | Media |
| | Mode | Waveform |
| | Auto Naming | OFF |
| COPY(MENU) | | |
| | Copy to | Printer |
| | Format | Normal |
| MEASURE | | |
| | Mode | OFF |
| | Trace | CH1 |
| | Item | OFF |
| | Delay Ref | Trig |
| | Dist/Prox Mode | Auto |
| CURSOR | | |
| | Type | OFF |
| MATH | | |
| | Mode | OFF |
| DISPLAY | | |
| | Main Format | Quad |
| | Interpolate | Sin |
| | Graticule | Grid |
| | Mapping | Auto |
| | Extra Window | OFF |
| | Scale Value | OFF |
| | Trace Label | ON |
| | Trigger Mark | ON |
| | Accumulate | OFF |

* For High-speed Isolation/High-speed module

| Menu key | soft key | Default setting |
|----------------------|-------------|-----------------|
| ZOOM | | |
| | Mode | Main |
| | Zoom Format | Main |
| | Mag Z1 | ×2 |
| | Mag Z2 | ×2 |
| | Z1Position | +0.00 div |
| | Z2Position | +0.00 div |
| CAL | | |
| | AutoCal | ON |
| POSITON/DELAY | | |
| | Position | 50% |
| | Delay | 0.0 μs |
| AUTOSETUP | | |
| | Center | 0 V |
| | CH | All |

Appendix 6 About User Defined Computations

Digital Filter

Type

| Type | Band |
|------------------|---------------------------|
| Gaussian | LowPass |
| Sharp | LowPass/HighPass/BandPass |
| IIR(Butterworth) | LowPass/HighPass/Bandpass |

Filter order

The following figure shows the filter order.

| | | 2% | 5% | 10% | 20% | 30%(Cutoff) |
|-------|----------|-----|----|-----|-----|-------------|
| Gauss | LowPass | 49 | 21 | 9 | 5 | 5 |
| Sharp | LowPass | 88 | 36 | 18 | 9 | 8 |
| | HighPass | 159 | 65 | 33 | 17 | 13 |
| IIR | LowPass | 4 | 4 | 4 | 3 | 2 |
| | HighPass | 4 | 4 | 4 | 4 | 3 |

Filter characteristics

| Filter | Pass-band ripple | Attenuation slope | Attenuation at stop-band | Phase |
|--------|------------------|--------------------------|--------------------------|-----------------|
| Gauss | 0dB | *1 | - | Linear phase |
| Sharp | ±0.3dB | -40dB at 1oct(Lowpass), | -40dB | Linear phase |
| | | -40dB at -1oct(Highpass) | | |
| IIR | 0dB | -5dB at 1/6oct(Lowpass), | - | No linear phase |
| | | -20dB at -1oct(Highpass) | | |

* Attenuation in the case of Gaussian filter : $-3.0 \times (f/f_c)^2$ dB (f : frequency, fc : cutoff frequency)

Frequency characteristics of each filter

f : frequency(Hz)

Gauss(Cutoff : 10%)

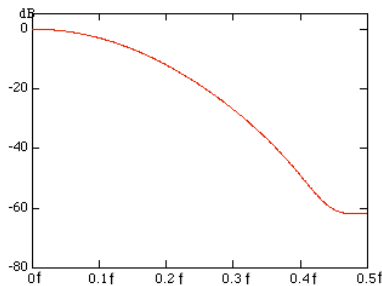

Sharp(Low Pass, Cutoff10%)

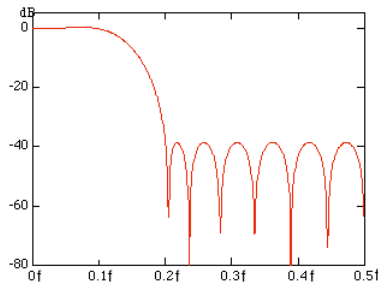

IIR(Low Pass, Cutoff10%)

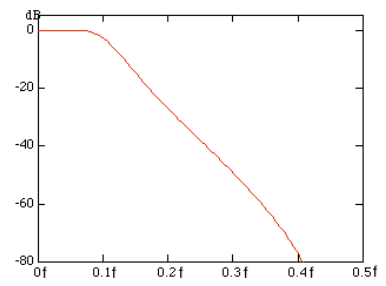

Note

The higher the order of the filter the more time it takes for the computation.

Hilbert Function (HLBT)

Normally, when we analyze a real time signal, it is convenient to think of this signal as the real part of the complex function and do the actual analysis using the complex function.

If the real time signal is considered the real part of the function, the imaginary part can be determined with the Hilbert transform of the real part. The Hilbert transform does not change the order of the individual variables. Hilbert transform of a time signal results in another time signal.

Hilbert transform is described below.

When transforming a signal in the time domain, the signal is transformed into the frequency domain, first, using the Fourier transform. Next, the phase of each frequency component is shifted by -90 deg if the frequency is positive and +90 deg if negative. Lastly, taking the inverse Fourier transform completes the Hilbert transform.

Example of an application

- Hilbert transform can be used to analyze an envelope waveform.
 AM modulation: $SQR(C1 * C1 + HLBT(C1) * HLBT(C1))$
 Demodulation of a FM signal: $DIF(PH(C1, HLBT(C1)))$

Phase Function

Phase function $PH(X1, Y1)$ computes $\tan^{-1}(X1/Y1)$.

However, the phase function takes the phase of the previous point into consideration and continues to sum even when the value exceeds $\pm\pi$ (ATAN function reflects at $\pm\pi$).

The unit is radians.

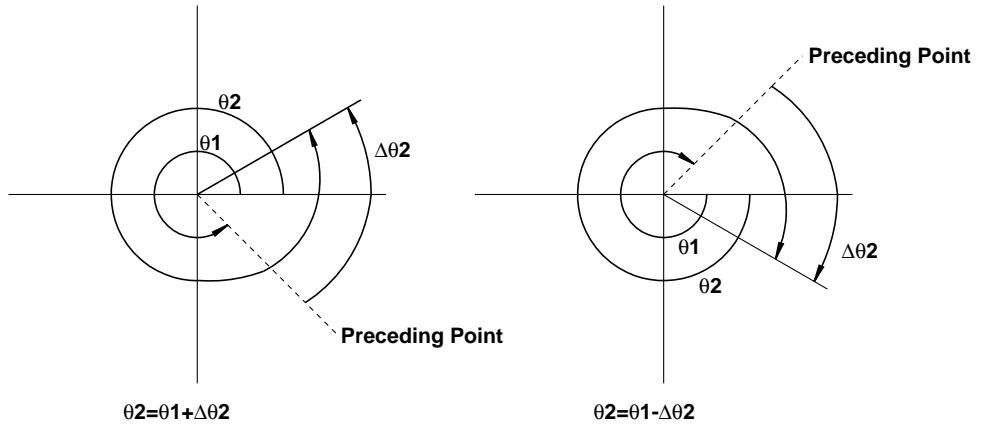

Pulse Width Computation

Binary computation is performed with respect to the threshold level, and the time of the pulse width is plotted as the Y-axis value for that interval.

Following 4 intervals are available.

PWHH Rising edge to the next rising edge

PWHL Rising edge to the next falling edge

PWLH Falling edge to the next rising edge

PWLL Falling edge to the next falling edge

PWXX Rising or falling edge to the next rising or falling edge

Example When the interval is set to PWHH

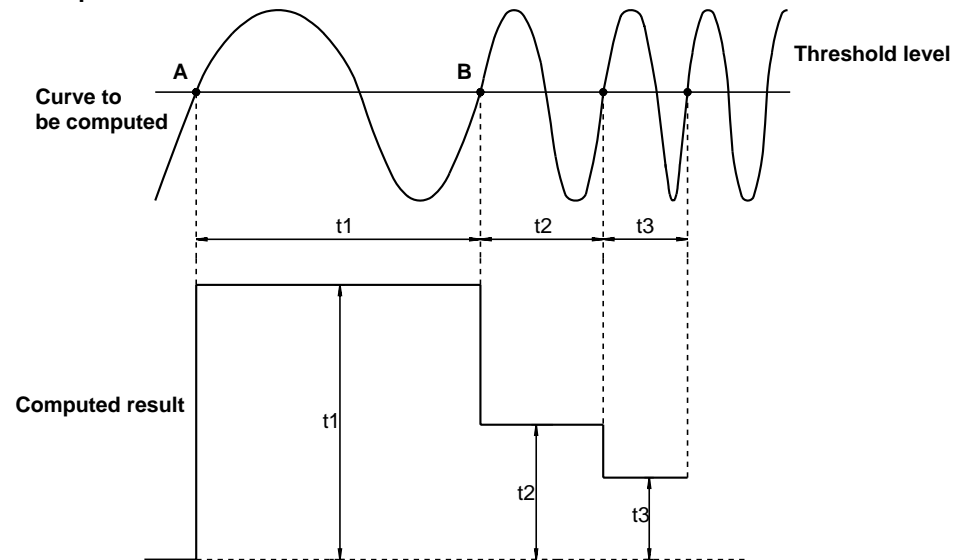

FFT function

Each frequency component G of a linear spectrum is represented by $G=R+jI$ (R: real part, I: imaginary part).

The dynamic ranges of the spectrums/functions are as follows.

Module 701850/701851 : 60 dB

Module 701852/701853 : 96 dB

Linear spectrum

Linear spectrum is a spectrum that can be directly determined with the FFT.

The magnitude and phase of each frequency component included in the measured waveform can be found. Power spectrum and cross spectrum can also be determined from 1 or 2 linear spectrums.

Since the FFT is a complex computation, real and imaginary parts can be obtained with the linear spectrum. The magnitude and phase of the linear spectrum can also be determined from the result.

The following spectrums can be determined with this instrument.

| Item | Expression | Computation |
|---------------|------------|-----------------------------------|
| Real | LS-REAL | R |
| Imaginary | LS-IMAG | I |
| Magnitude | LS-MAG | $\sqrt{(R^2+I^2)}$ |
| Log magnitude | LS-LOGMAG | $20 \times \log \sqrt{(R^2+I^2)}$ |
| Phase | LS-PHASE | $\tan^{-1}(I/R)$ |

Reference log magnitude(0dB) : 1Vpeak

Rms value spectrum

Rms value spectrum expresses the rms value of the magnitude of the linear spectrum. It does not contain phase information.

The following spectrums can be determined with this instrument.

| Item | Expression | Computation |
|---------------|------------|-------------------------------------|
| Magnitude | RS-MAG | $\sqrt{(R^2+I^2)}/2$ |
| Log magnitude | RS-LOGMAG | $20 \times \log \sqrt{(R^2+I^2)}/2$ |

Reference log magnitude(0dB) : 1Vrms

Power spectrum

Power spectrum expresses the power (squared value) of each frequency component included in the measured signal. It is determined by taking the product of the linear spectrum and its complex conjugate. It does not contain phase information.

The following spectrums can be determined with this instrument.

| Item | Expression | Computation |
|---------------|------------|------------------------|
| Magnitude | PS-MAG | $(R^2+I^2)/2$ |
| Log magnitude | PS-LOGMAG | $10 * \log(R^2+I^2)/2$ |

Reference log magnitude(0dB) : 1Vrms²

Power spectrum density

Power spectrum density expresses the power spectrum per unit frequency. It is determined by dividing the power spectrum with the frequency resolution Δf found during the analysis of the power spectrum. The computation varies depending on the window function.

Power spectrum density is used to compare power spectrums analyzed at different frequency bands. However, it is not necessary for signals having a line spectrum such as sine waves.

The following spectrums can be determined with this instrument.

| Item | Expression | Computation |
|---------------|------------|---|
| Magnitude | PSD-MAG | PS-MAG/ Δf (For Rectangular window) PS-MAG/1.5 Δf (For Hanning window) |
| Log magnitude | PSD-LOGMAG | 10xlogPS-MAG/ Δf (For Rectangular window) 10xlogPS-MAG/1.5 Δf (For Hanning window) |

Reference log magnitude(0dB) : 1Vrms²

Cross spectrum

Cross spectrum is determined from 2 signals. It is found by taking the product of the linear spectrum of one signal(G_y) and the complex conjugate (G_x^*) of the linear spectrum of the other signal (G_x).

If the linear spectrums of the 2 signals are represented by

$$G_x = R_x + jI_x$$

$$G_y = R_y + jI_y$$

then the cross spectrum G_{yx} is

$$G_{yx} = G_y \times G_x^* \\ = (R_y + jI_y)(R_x - jI_x) = R_{yx} + jI_{yx}$$

$$\text{where } R_{yx} = R_y R_x + I_y I_x$$

$$I_{yx} = R_x I_y - R_y I_x$$

The following spectrums can be determined with this instrument.

| Item | Expression | Computation |
|---------------|------------|---|
| Real | CS-REAL | $R_{yx}/2$ |
| Imaginary | CS-IMAG | $I_{yx}/2$ |
| Magnitude | CS-MAG | $\sqrt{(R_{yx}^2 + I_{yx}^2)}/2$ |
| Log magnitude | CS-LOGMAG | $10 \times \log \sqrt{(R_{yx}^2 + I_{yx}^2)}/2$ |
| Phase | CS-PHASE | $\tan^{-1}(I_{yx}/R_{yx})$ |

Transfer function

The transfer function expresses the frequency characteristics between the input to the transfer system and the output. The transfer function is determined by the ratio of the output linear spectrum (G_y) and the input spectrum (G_x) at each frequency. Also, as can be seen from the next equation, the transfer function can be defined as the ratio of the cross spectrum of the input and output (G_{yx}) and the input power spectrum (G_{xx}).

$$\text{Transfer Function} = G_y/G_x = (G_y \times G_x^*)/(G_x \times G_x^*) = G_{yx}/G_{xx} \\ = (R_{yx} + jI_{yx})/(R_x^2 + I_x^2)$$

The following spectrums can be determined with this instrument.

| Item | Expression | Computation |
|---------------|------------|---|
| Real | TF-REAL | $R_{yx}/(R_x^2 + I_x^2)$ |
| Imaginary | TF-IMAG | $I_{yx}/(R_x^2 + I_x^2)$ |
| Magnitude | TF-MAG | $\sqrt{(R_{yx}^2 + I_{yx}^2)}/(R_x^2 + I_x^2)$ |
| Log magnitude | TF-LOGMAG | $20 \times \log \sqrt{(R_{yx}^2 + I_{yx}^2)}/(R_x^2 + I_x^2)$ |
| Phase | TF-PHASE | $\tan^{-1}(I_{yx}/R_{yx})$ |

The magnitude of the transfer function shows the ratio of the magnitudes of the output linear spectrum and the input linear spectrum while the phase shows the phase difference of the two.

Coherence function

This expresses the ratio of the output power generated with the input signal to the transfer system and the total output power.

$$\text{Coherence function} = G_{yx} \times G_{yx}^*/(G_{xx} \times G_{yy})$$

| Item | Expression | Computation |
|-----------|------------|--|
| Magnitude | CH-MAG | $(R_{yx}^2 + I_{yx}^2)/(G_{xx} \times G_{yy})$ |

If the output signal is due entirely to the input signal, the coherence function becomes 1. As the ratio decreases, it falls below 1. Thus, the coherence function always takes on a value between 0 and 1.

Note

On 1 data acquisition, the coherence function becomes 1 across all frequencies. Also, make sure to take the frequency average of the computation.

Appendix 7 For Input Module 701850 and 701851

When using the High-Speed Isolation Module (701850) and High-Speed Module (701851), please note the points below. Operations that are not described here are the same as the 701855 and 701856. Please read the relevant sections carefully and always follow the warnings and cautions that are given.

Vertical Sensitivity (For Voltage Modules)(Page 1-3)

Note

Vertical sensitivity and measurement resolution

High-Speed Isolation Module (701850) and High-Speed Module (701851) use a 10 bit A/D converter and sample the input signal with a resolution of 1000 levels. Also, the waveform is displayed in 125 levels per 1 div on the grid.

Connecting a probe(Page 3-9)

Connect the probe (or other input cables such as the BNC cable) to any of the input terminals of the High-Speed Isolation/High-Speed Module.



WARNING

- When connecting the item to be measured, make sure to turn OFF the power on the item. Connecting or disconnecting the measurement input cable while the item being measured is turned ON is very dangerous.
- When making a voltage measurement on a common mode input voltage which is above 42 V (DC+ACpeak) with the High-Speed Isolation Module, make sure to use the dedicated probe, 700929.
- Applying a power above the value indicated below may cause damage to the input section. At a frequency above 1 kHz, damage may occur even when the voltage is lower than this voltage.

For High-Speed Isolation Module (701850)

Maximum input voltage (at a frequency of 1 kHz or less)

- Main instrument only (across the input terminals, H and L*¹)
250 V (DC+ACpeak)(CAT I and II, 177 Vrms)
- Combined with 700929 (across the probe tips, H and L*³)
850 V (DC+ACpeak)(CAT I and II, 600 Vrms)

Maximum allowable common mode voltage (at a frequency of 1 kHz or less)

- Main instrument only (across the input terminal, L, and earth*²)
42 V (DC+ACpeak)(CAT I and II, 30 Vrms)
- Combined with 700929 (across the probe tip, H or L, and earth*⁴)
400 Vrms (CAT I and II)
(Specification when the EN61010-1 standard does not need to be satisfied: 600 Vrms)

For High-Speed Module (701851)

Maximum input voltage (across the input terminals, H and L*⁵, at a frequency of 1 kHz or less)

250 V (DC+ACpeak)(CAT I and II, 177 Vrms)

Main instrument only

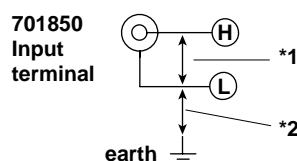

Combined with 700929

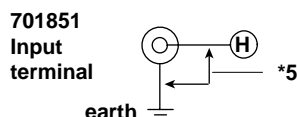
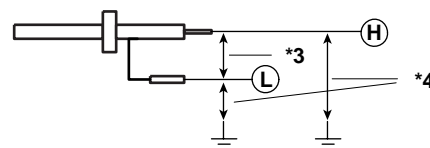

Points to Note when Connecting a Probe

- When connecting a probe to the instrument for the first time, perform phase correction of the probe as described in Section 3.10 “Compensating the Probe (Phase Correction)”. Failure to do so may result in unstable gain across different frequencies, thereby preventing correct measurement. Make the phase correction on each channel to which the probe is to be connected.
- If the object to be measured is connected to the instrument directly, without using a probe, correct measurement cannot be performed due to the input impedance.

Points to note when using a probe other than 700998 and 700929

- Correct measured values cannot be displayed if the probe’s attenuation ratio is not “1:1”, “10:1”, “100:1” or “1000:1”.

Setting the probe attenuation

Follow the operating procedure given in Section 5.6 “Selecting Probe Attenuation” (page 5-7) so that the probe’s attenuation matches the one displayed below “Probe” in the soft key menu. If they do not match, measured values cannot be read correctly.

V/div setting range(Page 5-4)

The setting range varies depending on the input module as shown below.

| Input module | Setting range |
|-------------------------------------|--------------------|
| High-Speed Isolation Module(701850) | 5mV/div to 20V/div |
| High-Speed Module(701851) | 5mV/div to 10V/div |

Bandwidth(Page 5-8)

High-Speed Isolation Module (Low pass filter)

Full, 500 kHz, 50 kHz, 5 kHz, 500 Hz

High-Speed Module (Low pass filter)

Full, 5 MHz, 500 kHz

Offset voltage setting range(Page 5-11)

The setting range varies depending on the input module as shown below.

For High-Speed Isolation Module

| Sensitivity Range (Probe=1:1) | Offset Voltage Setting Range |
|-------------------------------|------------------------------|
| 5 mV/div to 50 mV/div | -0.5 V to 0.5 V |
| 100 mV/div to 500 mV/div | -5 V to 5 V |
| 1 V/div to 5 V/div | -50 V to 50 V |
| 10 V/div to 20 V/div | -250 V to 250 V* |

The setting resolution is 0.01 div. If the voltage scale is 5 mV/div, for example, the setting resolution will 0.05 mV.

* Do not apply an input exceeding the maximum input voltage.

For High-Speed Module

| Sensitivity Range (Probe=1:1) | Offset Voltage Setting Range |
|-------------------------------|------------------------------|
| 5 mV/div to 50 mV/div | -0.5 V to 0.5 V |
| 100 mV/div to 500 mV/div | -5 V to 5 V |
| 1 V/div to 10 V/div | -50 V to 50 V |

The setting resolution is 0.01 div.If the voltage scale is 5 mV/div, for example, the setting resolution will 0.05mV.

Over view(Page 3-8)

| Input module | Abbreviation |
|-------------------------------------|--------------------------|
| High-Speed Isolation Module(701850) | HS_ISOL (same as 701855) |
| High-Speed Module(701851) | HS (same as 701856) |

Specifications : High-speed Isolation Module (701850)

| Item | Specifications |
|--|--|
| Number of input channels | 1 |
| Input coupling settings | AC, DC, GND |
| Maximum sample rate | 10 MS/s |
| Input format | Isolated unbalanced |
| Frequency characteristics* ¹ (-3 dB point when sine wave of amplitude ± 3 div is input) | DC to 2 MHz |
| Voltage-axis sensitivity setting | 5 mV/div to 20 V/div (1-2-5 steps) when using 700929 : 50 mV/div to 200 V/div (1-2-5 steps) |
| Maximum input voltage (At 1 kHz or less) | main instrument only (across input terminals H and L ^{*2}) 250 V(DC+ACpeak)(CAT I and II, 177 Vrms) combined with 700929 (across probe tips H and L ^{*4}) 850 V(DC+ACpeak)(CAT I and II, 600 Vrms) |
| Maximum allowable common mode voltage (At 1 kHz or less) | main instrument only (across input terminal L and earth ^{*3}) 42 V(DC+ACpeak)(CAT I and II, 30 Vrms) combined with 700929 (across probe tip H or L and earth ^{*5}) 400 Vrms (CAT I and II) (Specification when the EN61010-1 standard does not need to be satisfied: 600 Vrms) |
| DC offset range (max) (At 1:1 probe attenuation) | 5 mV/div to 50 mV/div : ± 0.5 V 100 mV/div to 500 mV/div : ± 5 V 1 V/div to 5 V/div : ± 50 V 10 V/div to 20 V/div : ± 250 V ^{*6} |
| Vertical (voltage) axis accuracy DC accuracy* ¹ (when bandwidth limit is off) Offset axis accuracy* ¹ (when bandwidth limit is off) • For suffix code style2 DC accuracy* ¹ Offset axis accuracy* ¹ | 10 mV/div to 20 V/div : ± (1.5% of 8 div + offset voltage accuracy) ± (0.04% of offset voltage range + 1% of setting value) 5 mV/div : ± (2% of 8 div + offset voltage accuracy) 10 mV/div to 20 V/div : ± (1.5% of 8 div + offset voltage accuracy) ± (0.04% of offset voltage range + 1% of setting value) |
| Input connector | BNC connector (isolating type) |
| Input impedance | 1 MΩ 1%, approx. 30pF |
| -3dB point for AC coupling used | 10 Hz or less(1 Hz or less when using 700929) |
| Common mode rejection ratio (At 1:1 probe attenuation, with voltage-axis sensitivity set to 100 mV/div or 1 V/div) | 80 dB(50/60 Hz) or more (typical* ⁸) |
| Residual noise* ⁷ • For suffix code style2 Residual noise* ⁷ | Larger of ± 400 μV or ± 0.05 div(typical* ⁸) Larger of ± 400 μV or ± 0.06 div(typical* ⁸) |
| Withstand voltage (across input terminal and earth) | 3700 VAC for 1 minute (60 Hz) |
| Isolation resistance (across input terminal and earth) | 500 VDC, 10 MΩ or more |
| A/D conversion resolution | 10 bit (125 LSB/div) |
| Probe attenuation settings | 1:1, 10:1, 100:1 and 1000:1 |
| Bandwidth limit | Select from OFF/500 Hz/5 kHz/ 50 kHz/ 500 kHz |

*1 Measured value under standard operating conditions (refer to page 15-6)

Main instrument only

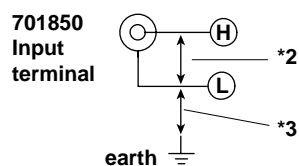

Combined with 700929

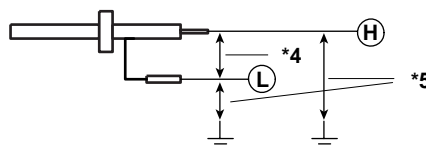

*6 Cannot exceed maximum input voltage

*7 Measured under the following conditions: input block shorted

*8 Typical (or average) value; not guaranteed

Specifications : High-speed Module (701851)

| Item | Specifications |
|--|---|
| Number of input channels | 1 |
| Input coupling settings | AC, DC, GND |
| Maximum sample rate | 10 MS/s |
| Input format | Non-isolated unbalanced |
| Frequency characteristics* ¹ (-1 dB point when sine wave of amplitude ± 3 div is input) | DC to 4 MHz |
| Voltage-axis sensitivity setting | 5 mV/div to 10 V/div (1-2-5 steps) |
| Maximum input voltage (At 1 kHz or less) | (across input terminals H and L* ²) 250 V(DC+ACpeak)(CAT I and II, 177 Vrms) |
| DC offset range (max) (At 1:1 probe attenuation) | 5 mV/div to 50 mV/div : ± 0.5 V 100 mV/div to 500 mV/div : ± 5 V 1 V/div to 10 V/div : ± 50 V |
| Vertical (voltage) axis accuracy DC accuracy* ¹ (when bandwidth limit is off) | 10 mV/div to 10 V/div : $\pm (1.5\% \text{ of } 8 \text{ div} + \text{offset voltage accuracy})$ |
| offset axis accuracy* ¹ (when bandwidth limit is off) | $\pm (0.04\% \text{ of offset voltage range} + 1\% \text{ of setting value})$ |
| Input connector | BNC connector |
| Input impedance | 1 M Ω 1%, approx. 30pF |
| -3dB point for AC coupling used | 10 Hz or less(1 Hz or less when using 10:1 probe) |
| Residual noise* ³ | Larger of $\pm 300 \mu\text{V}$ or ± 0.04 div(typical* ⁴) |
| A/D conversion resolution | 10 bit (125 LSB/div) |
| Probe attenuation settings | 1:1, 10:1, 100:1 and 1000:1 |
| Bandwidth limit | Select from OFF/ 500 kHz/ 5 MHz |

*1 Measured value under standard operating conditions (refer to page 15-6)

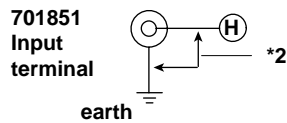

*3 Measured under the following conditions: input block shorted

*4 Typical (or average) value; not guaranteed

Appendix 8 Compatibility between Input Modules and DL708E

The input modules that can be used with different firmware versions of DL708E are indicated below.

| Input Module | Name | Firmware versions of DL708E*1 |
|-----------------|---|-------------------------------|
| 701850 | High-Speed Isolation Module | all versions |
| 701850 style2*2 | High-Speed Isolation Module | 3.00 or later |
| 701851 | High-Speed Module | all versions |
| 701852 | High-Resolution, High-Voltage, Isolation Module | 2.00 or later |
| 701853 | High-Resolution, Isolation Module | 2.00 or later |
| 701855 | High-Speed Isolation Module | 4.00 or later |
| 701856 | High-Speed Module | 4.00 or later |
| 701860 | Temperature Module | 2.00 or later |
| 701870 | Logic Input Module | 2.00 or later |
| 701880 | Strain Module | 3.00 or later |

*1 Please contact your nearest YOKOGAWA dealer to have the firmware upgraded.

*2 "701850 style2" is written on the data plate of the module.

Index

A

A → B (n) trigger 1-7, 6-10
 A Delay B trigger 1-8, 6-12
 Accessories 3, 4
 Accumulate 1-16, 8-5
 ACQ key 2-3
 Acquisition count 7-2
 Acquisition mode 1-12, 7-2
 Action on trigger 1-24, 13-5
 Anti-aliasing filter 5-8
 Attenuation constant 7-2
 Auto calibration 2-5, 4-9
 Auto level 1-10, 6-1
 Auto naming 11-8, 13-5
 Auto scaling 9-9, 9-18
 Auto set-up 1-23, 4-4
 Automatic measurement of waveform parameters 1-20, 9-4
 Averaging mode 1-12, 7-2, 9-20

B

B>Time, B<Time, B Time out trigger 1-9, 6-17
 Bandwidth limit 1-5, 5-8
 Bar display 2-5
 Bit Mapping 5-18
 Block diagram 1-1
 Box average 1-13, 7-5
 Bridge head 3-16

C

Calibration 4-9
 Centronics connector 10-6
 Centronics interface 10-6
 Channel ON/OFF 5-1
 CLEAR key 2-3
 Clear trace 1-23, 4-8
 Color grade width 8-5
 COMPLE 9-15
 Computation 1-20, 9-9
 averaging 9-20
 number of points 9-9, 9-17
 using phase shifting 9-13
 COPY key 2-4
 Count 7-3
 Cover panel 3-7
 Creating directories 11-7
 CURSOR key 2-3
 Cursor measurements 1-19, 9-1
 Cutoff frequency 9-20, App-9
 Cycle averaging 1-22, 9-20

D

D/A conversion 9-15
 Data compression 8-2, 10-8, 10-12
 Digital filter 9-20, App-9
 Directories (creating) 11-7
 Directories (selecting) 11-7
 Display format 1-15, 8-1
 Display interpolation 1-16, 8-2
 DISPLAY key 2-3
 Display record length 1-12
 Display style 8-2

E

Edge on A trigger 1-8, 6-14
 Edge Trigger 1-7, 6-9
 ENHANCED key 2-2
 Enhanced trigger 1-7, 6-10, 6-12, 6-14, 6-16, 6-17, 6-19
 Entering values 4-1
 Envelope mode 1-13, 7-2, 8-2
 Error messages 14-2
 Exponential averaging (averaging mode) 1-12, 7-2
 Exponential averaging (user defined computation) 1-22, 9-20
 External clock input 2-1, 4-11, 15-2
 External trigger input 2-1, 12-1
 Extra window 1-15, 8-7

F

FFT 1-21, 9-17, 9-21, App-12
 File copy 11-17
 File deletion 11-16
 FILE key 2-4
 Files that should not be deleted 11-21
 Filters 1-5, 5-8
 Flattop window 1-21, 9-17
 Floppy disk 11-1
 Format 11-4
 Front panel 2-1

G

Graticule 1-15, 8-4

H

H cursors 9-1
 Half tone 10-6, 10-8, 10-12
 Hanning window 1-21, 9-17
 Hard copy 10-4
 Help 4-10
 HELP key 2-4
 Hilbert transform 9-19, App-10
 HISTORY key 2-3
 History memory 1-14, 7-6

I

ID number change 11-19, 11-20
 Initialization 1-23, 4-3
 Input cable 3-11
 Input coupling 1-4, 5-6
 Input filter 1-5, 5-8
 Input module 3
 Inputting character strings 4-2
 Installing input modules 3-7
 Internal hard disk 1-14, 11-2
 Interpolate 8-2
 Isolation probe 3-9

J

Jog shuttle 2-1, 2-3

L

| | |
|---|-------------------|
| Line interpolation | 8-2 |
| Linear averaging (averaging mode) | 1-12, 7-2 |
| Linear averaging (user defined computation) | 1-22, 9-20 |
| Linear scaling (strain module) | 5-22 |
| Linear scaling (voltage module) | 1-19, 5-12 |
| Linear spectrum | 9-19, App-12 |
| Log Start | 4-6 |
| Logic format | 11-4 |
| Logic input probe | 3-15, 5-18, 15-14 |

M

| | |
|--|-------------|
| Main Format | 8-1 |
| Main Position | 1-18, 8-12 |
| Main waveform | 1-17, 8-12 |
| Manual scaling | 9-18 |
| Mapping | 5-18, 8-1 |
| Marker cursor | 9-1 |
| Marker jump | 9-2 |
| MATH key | 2-3 |
| Maximum sample rate | 5-2 |
| Measure | 1-20, 9-4 |
| MEASURE key | 2-3 |
| Measurement cable | 3-11 |
| Media selection | 11-7 |
| Memory capacity for saving | 11-8, 11-12 |
| Message language | 13-3 |
| MISC key | 2-4 |
| Module installation | 3-7 |
| Moving the waveform display position | 1-18, 8-12 |

N

| | |
|----------------------|----------------------|
| Names of parts | 2-1 |
| Normal mode | 1-10, 1-12, 6-1, 7-2 |

O

| | |
|--|-------------------------|
| Offset voltage | 1-5, 5-11 |
| Online help | 4-10 |
| Option | 2 |
| OR trigger | 1-8, 6-16 |
| Outputting the screen image data | 10-4, 10-6, 10-8, 10-12 |
| Outputting to the plotter | 10-8 |
| Overview | 14-7 |

P

| | |
|--|--------------------|
| Paper feed knob | 10-2 |
| Peak computation | 1-22, 9-20 |
| Phase correction | 3-15 |
| Phase function | 9-19, App-10 |
| Points | 9-17 |
| Position | 1-4, 5-5 |
| POSITION/DELAY key | 2-2 |
| Power spectrum | 1-21, 9-17, App-12 |
| Power supply | 3-4 |
| Printing to the external plotter | 10-8 |
| Probe | 1-4, 3-9 |
| Pulse width computation | 9-19, App-11 |
| Pulse width trigger | 1-9, 6-17 |

Q

| | |
|--------------------|------|
| Quick format | 11-4 |
|--------------------|------|

R

| | |
|---------------------------------------|-----------------|
| Realtime print | 1-14, 7-9 |
| Realtime record | 1-14, 7-9, 7-11 |
| Record length | 1-12, 7-1 |
| Rectangular window | 1-21, 9-17 |
| Reference junction compensation | 1-6 |
| Release arm | 10-2 |
| Replaceable parts | 14-8 |
| RESET key | 2-3 |
| RJC | 1-6, 5-16 |
| Roll mode display | 1-3, 5-2 |
| Roll paper | 10-1 |
| Roller | 10-2 |
| Running | 2-5 |

S

| | |
|---|------------------|
| Sample rate | 1-3 |
| Savable data | 11-8 |
| Saving setup data | 11-12 |
| Saving waveform data | 11-8, 11-14 |
| Scale values | 1-15, 8-8 |
| Scaling | 1-19, 5-12, 9-18 |
| Scaling the computation waveform | 1-20, 9-18 |
| Screen display | 2-5 |
| Screen saver | 13-4 |
| SCSI device | 11-3 |
| SCSI device selection | 11-19 |
| SCSI ID number setting range | 11-19 |
| SCSI interface | 11-3 |
| SCSI terminator | 11-3, 11-22 |
| SELECT key | 2-3 |
| Selecting directories | 11-7 |
| Selecting files to delete | 11-16 |
| Self test | 14-5 |
| Sequential store | 1-13, 7-4 |
| Set Action | 13-5 |
| SETUP key | 2-3 |
| SIMPLE key | 2-2 |
| Simple trigger | 1-7, 6-9 |
| Sine interpolation | 8-2 |
| Single Start | 4-6 |
| SNAP SHOT key | 2-3 |
| Snapshot | 1-23, 4-8 |
| Soft key | 2-5 |
| Specifications | |
| Built-in printer | 15-5 |
| Centronics interface | 15-4 |
| Display section | 15-2 |
| External dimensions | 15-8 |
| External Input/Output | 15-4 |
| Functions | 15-2, 15-3 |
| General | 15-6 |
| GP-IB interface | 15-4 |
| High-Resolution, High-Voltage, Isolation Module | 15-11 |
| High-Resolution, Isolation Module | 15-12 |
| High-speed Isolation Module | 15-9 |
| High-speed Module | 15-10 |
| Input section | 15-1 |
| Internal floppy disk | 15-5 |
| Internal hard disk | 15-5 |
| Logic Input Module | 15-14 |
| RS-232 interface | 15-4 |
| SCSI interface | 15-5 |
| Strain Module | 15-15 |
| Temperature Module | 15-13 |
| Time axis | 15-2 |
| Trigger section | 15-1 |

| | |
|------------------------------|-------------|
| Split | 10-4 |
| Split print | 10-4 |
| START/STOP | 4-6 |
| Stopped | 2-5 |
| Strain | 5-19, 15-15 |
| Synchronized operation | 12-1 |

T

| | |
|-------------------------------|-----------------|
| T/div | 1-2, 5-2 |
| Temperature measurement | 1-6, 5-16 |
| Terminator | 11-19 |
| Thermocouple | 1-6, 3-12, 5-16 |
| Threshold level | 3-14, 9-20 |
| Time | 3-6 |
| Time axis setting | 1-2, 5-2 |
| Time base | 4-11 |
| Time window | 9-17 |
| Time-stamp lists | 7-6, 7-8 |
| Timer Trigger | 6-21 |
| Timing chart | 12-1, 12-2 |
| Transfer function | 9-19, App-13 |
| Trig In | 12-1, 15-4 |
| Trig Out | 4-11, 15-4 |
| Trigger delay | 1-11, 6-8 |
| Trigger hold-off | 1-11, 6-5 |
| Trigger hysteresis | 1-10, 6-2, 6-3 |
| Trigger level | 1-10, 6-2, 6-4 |
| Trigger mark | 1-15, 8-8 |
| Trigger mode | 1-10, 6-1 |
| Trigger output | 2-1, 12-2 |
| Trigger position | 1-11, 6-6 |
| Trigger source | 1-10, 6-2, 6-4 |
| Trigger types | 1-7 |

U

| | |
|--------------------------------|------------|
| User defined computation | 1-22, 9-19 |
| User defined cursor | 1-19, 9-1 |

V

| | |
|--------------------------------|-----------|
| V cursors | 9-1 |
| V/div | 1-4, 5-4 |
| Vertical position | 1-4, 5-5 |
| Video Out | 2-1, 12-3 |
| Video output terminal | 12-3 |
| Voltage axis sensitivity | 1-3, 5-4 |

W

| | |
|----------------------------|------------|
| Warm up | 3-5 |
| Warranty | 14-8 |
| Waveform computation | 1-20, 9-9 |
| Waveform label | 1-15, 8-9 |
| Window | 1-21, 9-17 |
| Window displays | 8-1 |
| Window function | 1-21, 9-17 |
| Window trigger | 1-9, 6-19 |

X

| | |
|----------------------------|------------|
| X-Y waveform display | 1-17, 8-10 |
|----------------------------|------------|

Z

| | |
|---------------------|-----------------------|
| Z1 Position | 8-12 |
| Zoom | 1-5, 1-17, 5-10, 8-12 |
| Zoom position | 8-12 |